

RFD2000

RFID SLED



User Guide



ZEBRA

Copyright

© 2018 ZIH Corp. and/or its affiliates. All rights reserved. ZEBRA and the stylized Zebra head are trademarks of ZIH Corp., registered in many jurisdictions worldwide. All other trademarks are the property of their respective owners.

COPYRIGHTS & TRADEMARKS: For complete copyright and trademark information, go to www.zebra.com/copyright.

WARRANTY: For complete warranty information, go to www.zebra.com/warranty.

END USER LICENSE AGREEMENT: For complete EULA information, go to www.zebra.com/eula.

For Australia Only

For Australia Only. This warranty is given by Zebra Technologies Asia Pacific Pte. Ltd., 71 Robinson Road, #05-02/03, Singapore 068895, Singapore. Our goods come with guarantees that cannot be excluded under the Australia Consumer Law. You are entitled to a replacement or refund for a major failure and compensation for any other reasonably foreseeable loss or damage. You are also entitled to have the goods repaired or replaced if the goods fail to be of acceptable quality and the failure does not amount to a major failure.

Zebra Technologies Corporation Australia's limited warranty above is in addition to any rights and remedies you may have under the Australian Consumer Law. If you have any queries, please call Zebra Technologies Corporation at +65 6858 0722. You may also visit our website: www.zebra.com for the most updated warranty terms.

Terms of Use

- Proprietary Statement

This manual contains proprietary information of Zebra Technologies Corporation and its subsidiaries ("Zebra Technologies"). It is intended solely for the information and use of parties operating and maintaining the equipment described herein. Such proprietary information may not be used, reproduced, or disclosed to any other parties for any other purpose without the express, written permission of Zebra Technologies.

- Product Improvements

Continuous improvement of products is a policy of Zebra Technologies. All specifications and designs are subject to change without notice.

- Liability Disclaimer

Zebra Technologies takes steps to ensure that its published Engineering specifications and manuals are correct; however, errors do occur. Zebra Technologies reserves the right to correct any such errors and disclaims liability resulting therefrom.

- Limitation of Liability

In no event shall Zebra Technologies or anyone else involved in the creation, production, or delivery of the accompanying product (including hardware and software) be liable for any damages whatsoever (including, without limitation, consequential damages including loss of business profits, business interruption, or loss of business information) arising out of the use of, the results of use of, or inability to use such product, even if Zebra Technologies has been advised of the possibility of such damages. Some jurisdictions do not allow the exclusion or limitation of incidental or consequential damages, so the above limitation or exclusion may not apply to you.

Revision History

Changes to the original manual are listed below:

Change	Date	Description
-01 Rev A	12/2017	Initial release
-02 Rev A	5/2018	Rev B Software Updates: - "Import RFID Manager Into StageNow" chapter name change to "RFID Manager StageNow Plug-in." - Updates to "RFID Manager StageNow Plug-in" chapter.

Table of Contents

Copyright	2
For Australia Only	2
Terms of Use	2
Revision History	3
About This Guide	
Introduction	7
Configurations	7
Chapter Descriptions	8
Notational Conventions	8
Related Documents and Software	9
Service Information	9
Getting Started	
Introduction	10
Unpacking	10
RFID Sled Features	11
LED Definitions	12
RFD2000 LED Definitions While Charging	12
RFD2000 LED Definitions When Not Charging	12
LED Indications	13
RFID Sled Battery Replacement	14
Removing Battery	14
Installing Battery	15
Attach/Remove Mobile Computer to RFID Sled	16
Attaching Mobile Computer to RFID Sled	16
Removing Mobile Computer to RFID Sled	16
Installing the Lanyard	17
Charging	17
Battery Management	18
Low Battery Notification	18
Battery Optimization	18
Mobile Device	18

Zebra RFID Mobile Application for Android

Introduction 19

Requirements 19

Installing Zebra RFID Mobile Application for Android 19

Zebra RFID Mobile Application for Android 20

 Using the Zebra RFID Mobile Application for Android 20

 Connecting TC20 to the RFD2000 21

 Disconnecting the RFD2000 21

 Demo Application Screens 22

 Rapid Read 23

 Inventory 24

 Locate Tag 26

 Settings 27

 Access Control 39

 Pre Filters 40

 About 41

RFID Manager

Introduction 42

Setting Up the RFD2000 43

Installing RFID Manager for Android 43

 Requirements 43

 Installation 43

Using the RFID Manager for Android 43

 Connection Status 44

 RFID Regulatory 46

 Settings 47

 Firmware Update 49

 Recovery Mode 51

 RFID Manager Log 52

 Beeper Indications 53

 About 53

Introduction 54

Application Usage and Screens 54

RFID Scan-Scan-Write

Settings 58

StageNow

StageNow Staging Solution 59

RFID Manager StageNow Plug-in

Introduction 60

Requirements 60

Importing RFID Manager CSP Plug-in 61

Creating Firmware Update Profile Using StageNow 63

Creating Reader Configurations 68

Table of Contents

Creating Reset Radio and Reset to Factory Profiles	70
Applying Firmware and Regulatory Updates in One Profile	73
Maintenance and Troubleshooting	
Introduction	74
Cleaning	74
Approved Cleanser Active Ingredients	74
Harmful Ingredients	74
Cleaning Instructions	74
Special Cleaning Notes	75
Materials Required	75
Cleaning Cradle Connectors	75
Cleaning Frequency	75
Maintenance	75
RFD2000	76
Battery	76
Troubleshooting	76
Troubleshooting RFD2000 RFID Sled with Default LED	76
Troubleshooting RFD2000 RFID Sled with LED Mode 2	78
Data Dictionary	
Introduction	79
RFD2000 Attributes	79
Attribute Definitions	79
Inventory Command Configurations	80
Tag Select Configurations	83
Tag Query Configurations	87
Tag Access Configurations	88
Region Configurations	90
Peripheral Configurations	93
Trigger Configurations	93
ASCII Configurations	94
Tag Access Criteria Configurations	96
Locate Tag Configurations	98
Dynamic Power Configurations	98
Duty Cycle Configurations	98
Power Mode Configurations	99
Unique Tag Report Configurations	100
Other RFID Configurations	100
System Configurations	100
Action Values	101
Index	

ABOUT THIS GUIDE

Introduction

The RFD2000 RFID Sled User Guide provides general instructions for using the RFID Sled.

Configurations

Table 1 RFD2000 Configurations

Configuration	Description
RFD2000-1000100-US	RFID Sled; United States
RFD2000-1000100-EU	RFID Sled; Europe
RFD2000-1000100-JP	RFID Sled; Japan
RFD2000-1000100-IN	RFID Sled; India
RFD2000-1000100-KR	RFID Sled; Korea
RFD2000-1000200-US	RFID Sled; Inditex; United States
RFD2000-1000200-EU	RFID Sled; Inditex; Europe
RFD2000-1000200-IN	RFID Sled; Inditex; India
RFD2000-1000200JP	RFID Sled; Inditex; Japan

Table 2 RFD2000 Accessories

Configuration	Description
CRD1S-RFD2000-1R	Single Slot Charging Cradle
CRD5S-RFD2000-1R	Five Slot Charging Cradle
BTRY-RF20GAB0E-00	Spare Battery
BTRY-RF20GAB0E-00K	Spare Battery; India and Korea

Chapter Descriptions

Topics covered in this guide are as follows:

- [Getting Started](#) provides information on RFD2000 RFID Sled parts, battery installation, mobile device attachment, LED indications, and charging.
- [Zebra RFID Mobile Application for Android](#) describes the Zebra RFID Mobile Application for Android which demonstrates RFD2000 capability and tag operation functionality.
- [RFID Manager](#) describes how to install and configure the Zebra RFID Manager Application for the TC20 Android mobile device used with the RFD2000.
- [RFID Scan-Scan-Write](#) demonstrates the use case of using the Android Mobile Device to program tags using the RFD2000.
- [Maintenance and Troubleshooting](#) describes cleaning, maintenance, and troubleshooting procedures.
- [StageNow](#) provides a reference to access this easy Wizard-based tool that allows even complex Staging profiles to become simple to create.
- [RFID Manager StageNow Plug-in](#) provides instruction necessary to generate a RFID Firmware update profile and import RFID CSP plug-in into the StageNow application.
- [Data Dictionary](#) includes RFD2000 attribute information (configuration parameters, monitored data, and born on information about the device).

Notational Conventions

The following conventions are used in this document:

- “RFID Sled” refers to the RFD2000 RFID Sled.
- Bold text is used to highlight the following:
 - Dialog box, window and screen names
 - Drop-down list and list box names
 - Check box and radio button names
 - Icons on a screen
 - Key names on a keypad
 - Button names on a screen.
- Bullets (•) indicate:
 - Action items
 - Lists of alternatives
 - Lists of required steps that are not necessarily sequential
- Sequential lists (e.g., those that describe step-by-step procedures) appear as numbered lists.

Related Documents and Software

The following documents and software provide more information about the reader

- RFD2000 Quick Start Guide, p/n MN-003129-xx
- CRD1S-RFD2000 and SHARECRADLE-MC Cradle Regulatory Guide, p/n MN-003127-xx
- RFD2000 Developer Guide, p/n MN-003158-xx
- Zebra RFID SDK for Android Developer Guide, p/n MN-003158-xx
- TC20 Quick Start Guide, p/n MN-003018-xx
- TC20 User Guide, p/n MN-003020-xx
- developer.zebra.com/community/android/stagenow
- techdocs.zebra.com/stagenow/2-10/about/

For the latest version of this guide and all guides, go to: www.zebra.com/support.

Service Information

If you have a problem using the equipment, contact your facility's technical or systems support. If there is a problem with the equipment, they will contact the Zebra Global Customer Support Center at: www.zebra.com/support.

When contacting Zebra support, please have the following information available:

- Serial number of the unit
- Model number or product name
- Software type and version number.

Zebra responds to calls by e-mail, telephone or fax within the time limits set forth in support agreements.

If your problem cannot be solved by Zebra support, you may need to return your equipment for servicing and will be given specific directions. Zebra is not responsible for any damages incurred during shipment if the approved shipping container is not used. Shipping the units improperly can possibly void the warranty.

If you purchased your business product from a Zebra business partner, contact that business partner for support.

Getting Started

Introduction

This chapter provides information on RFD2000 RFID Sled parts, battery installation, mobile device attachment, LED indications, and charging.

Unpacking

Carefully remove all protective material from the RFD2000 RFID Sled and save the shipping container for later storage and shipping. Verify the following items are in the box:

- RFD2000
- Battery
- Lanyard
- Quick Start Guide

Inspect the equipment for damage. If any equipment is missing or damaged, contact the Zebra Support Center immediately. See [Service Information on page 9](#) for contact information.

RFID Sled Features

The RFD2000 RFID Sled adds a RFID gun-style handle with a scanning trigger to the TC20 mobile computer. Used for all RFID operations, the RFD2000 increases comfort when using the mobile computer in scan-intensive applications for extended periods of time.

Figure 1 RFD2000 RFID Sled Features

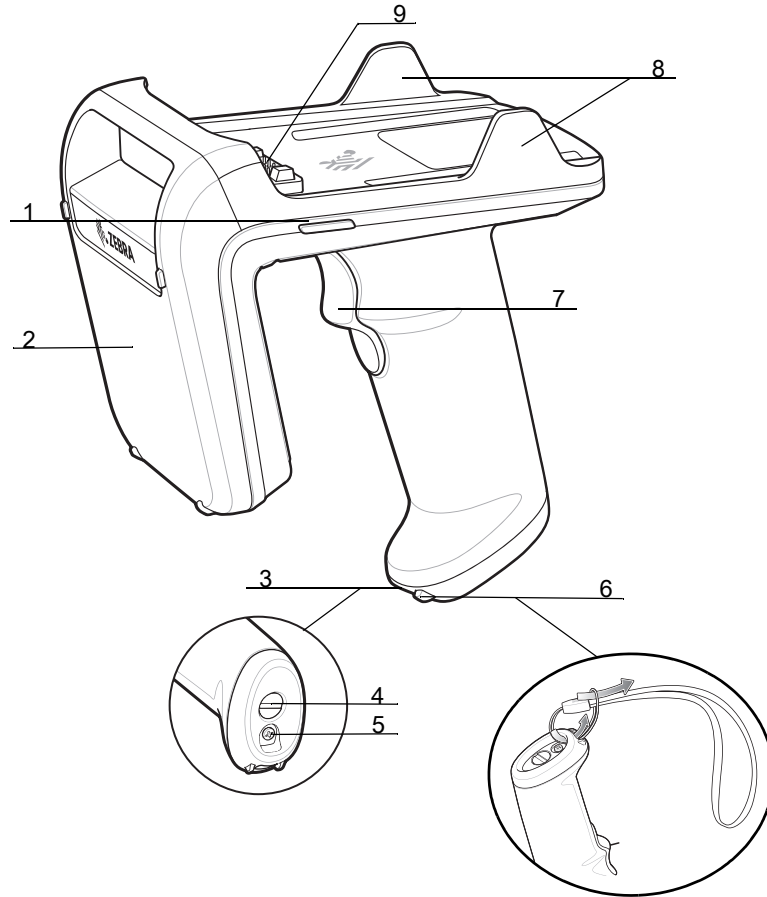

Table 3 RFD2000 Parts

Number	Item
1	LED Indicator (2)
2	Antenna
3	Battery Compartment
4	Battery Compartment Latch
5	Battery Compartment Screw
6	Lanyard Hook
7	Trigger
8	Retention Clip (2)
9	Connector for TC20

LED Definitions

RFD2000 LED Definitions While Charging

The RFD2000 RFID Sled uses a two-color LED to indicate status.

Table 4 RFD2000 LED Definitions While Charging

Condition	RFD2000 Power LED
Pre-charging	Amber (Fast, Fast, Slow)
Charging	Amber (Blinking)
Fully Charged	Green (Stays On)
Charging Error	Amber (Fast Blinking)

RFD2000 LED Definitions When Not Charging

Table 5 RFD2000 LED Definitions When Not Charging

Mode	Condition	RFD2000 Power LED	TC20
LED Mode 0 - All LED Feedback Disabled	Tag Read Indications and Battery Indication Off	Off	Four Short Beeps when the battery SOC (State of Charge) is below 10%
LED Mode 1 - Tag Read Indication Enabled	Tag Read Indication Enabled (Default)	Green LED Blinks	Four Short Beeps when the battery SOC (State of Charge) is below 10%
LED Mode 2 - Battery Indication Enabled	Battery Charge Status ¹	Green when remaining charge is 99%-51% Amber when remaining charge is 21%-50% Red when remaining charge is 0%-20%	
	Low Battery Charge Status ¹	Red when remaining charge is 0%-10%	Four Short Beeps when the battery SOC (State of Charge) is below 10%
LED Mode 3 - Low Battery Indication Enabled	No LED for Normal Charge Status	No LEDs if Charge Status is more than 10%	
	Low Battery Charge Status ¹	Red when remaining charge is 0%-10%	Four Short Beeps when the battery SOC (State of Charge) is below 10%

¹The battery charge status LED Indicator stays On for four seconds when the RFD2000 RFID Sled is removed from the charging cradle.

LED Indications

Power Up

To power up the RFD2000 RFID Sled when it is powered off, press the trigger continuously for 1.3 seconds. The LED blinks amber once when RFD2000 RFID Sled begins to boot up.

Recovery Mode

To place the RFD2000 RFID Sled in Recovery Mode, press the trigger continuously for 20 seconds when it is powered off. The LED remains solid red to indicate the RFD2000 RFID Sled is in Recover Mode.

Firmware Update

When the RFD2000 RFID Sled firmware update is in progress, the LED blinks green.

Battery Error

When an invalid battery is used with the RFD2000 RFID Sled, the LED blinks red. Ensure to only use the battery manufactured for use with the RFD2000.

Battery End of Life

The Battery End of Life indication is disabled by default. When enabled the LED indication for battery health percentage is as follows:

- Green/Red alternate blinking when end of life percentage is 99%-51%
- Amber/Red alternate blinking when end of life percentage is 21%-50%
- Red blinking when remaining end of life percentage is 0%-20%.

If the battery health percentage falls below the configurable threshold (default is 60%), the battery end of life indication replaces the battery charge status.

RFID Sled Battery Replacement

Removing Battery

To remove the battery:



NOTE: Fully charge the RFD2000 RFID Sled before initial use.

1. Remove the Battery Compartment Screw using a Phillips head screw driver.
2. Turn the Battery Compartment Latch counter clockwise approximately 30° using a flat head screw driver or coin.
3. Remove the Battery Compartment Cap.
4. Remove the battery.

Figure 2 RFID Sled Battery Removal

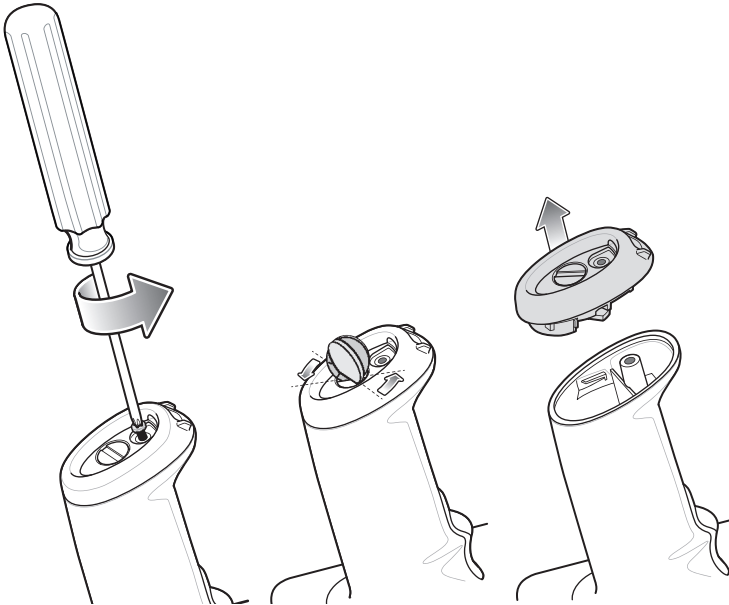

Installing Battery

To install the battery:

1. Insert the battery, connector end first, contacts facing toward the trigger, into the Battery Compartment.
2. Place the Battery Compartment Cap on.
3. Turn the Battery Compartment Latch clockwise using a flat head screw driver or coin.
4. Insert the Battery Compartment Screw and tighten using a Phillips head screw driver.

Figure 3 RFID Sled Battery Insertion

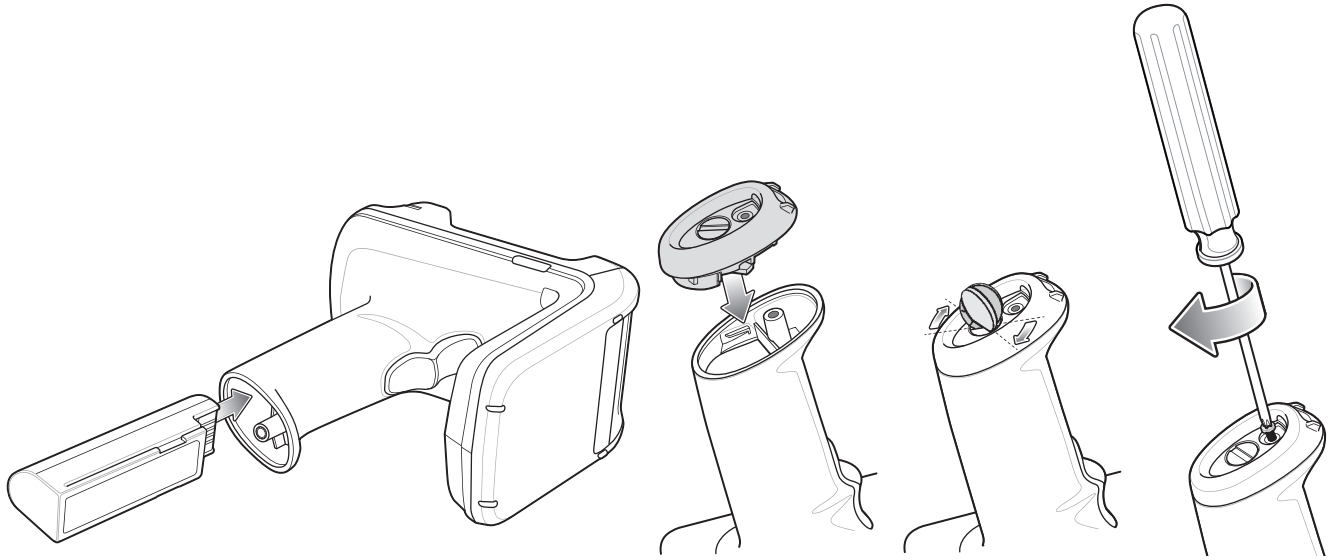

Attach/Remove Mobile Computer to RFID Sled

Attaching Mobile Computer to RFID Sled

To secure the TC20 Mobile Computer to the RFD2000 RFID Sled, place the TC20 fully forward on the Sled base and push the TC20 down into the Retention Clips.

Figure 4 Attach Mobile Computer to RFID Sled

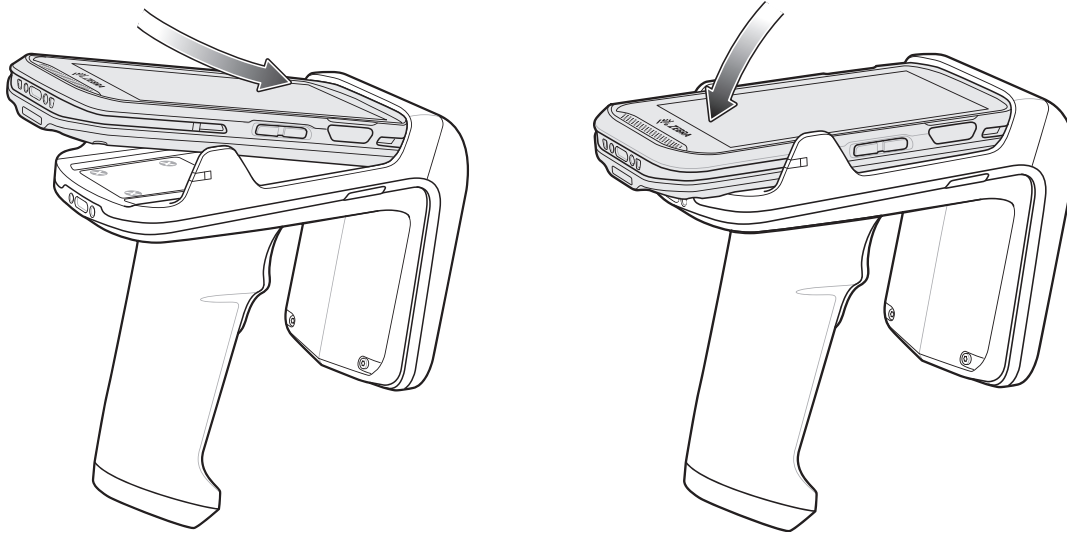

Removing Mobile Computer to RFID Sled

To remove the TC20 Mobile Computer from the RFD2000 RFID Sled, firmly hold the Sled handle, and lift the TC20 off of the Sled base.

Figure 5 Remove Mobile Computer from RFID Sled

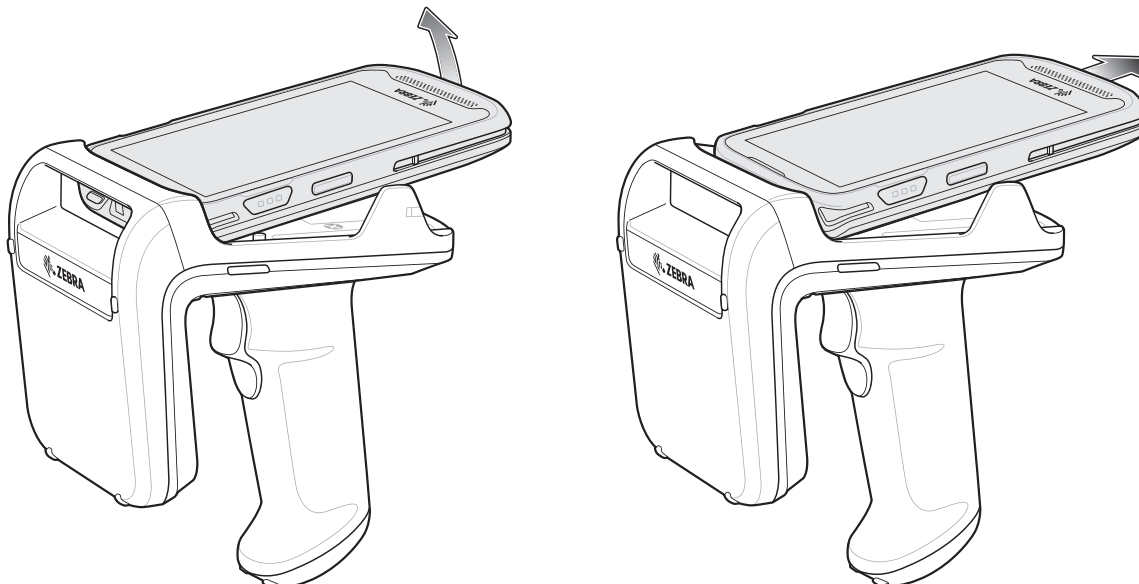

Installing the Lanyard

To install the optional lanyard:

1. Insert the loop on the lanyard into the lanyard hook located at the bottom of the RFD2000 handle.
2. Thread the upper portion of the lanyard into the loop.
3. Pull the clip through the loop over the tether point and tighten into place.

Figure 6 Installing the Lanyard

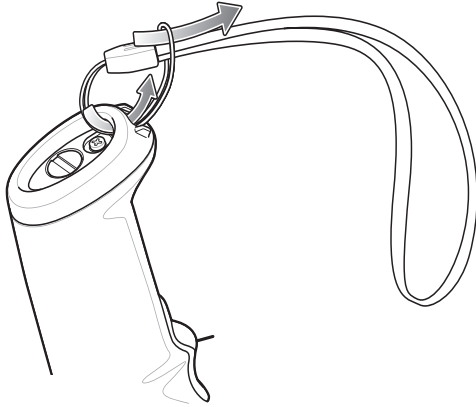

Charging

Before using the RFD2000 for the first time, fully charge the battery by placing it in the charging cradle until the LED Power/Charging Indicator turns solid green (see [LED Definitions on page 12](#) for charge status indications). The RFD2000 RFID Sled and TC20 Mobile Computer may be charged in the charging cradle individually or attached together.

When an RFD2000 RFID Sled is removed from a charging cradle, it is automatically powered on. If a reader is not used for a duration of thirty minutes, the reader enters Off mode. Pressing the handle trigger for 1.3 seconds turns the reader back on.

Figure 7 Charging Cradles
Single Slot Charging Cradle

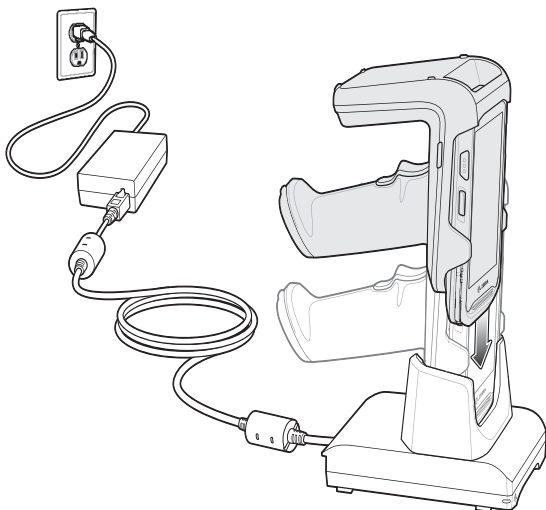

Five Slot Charging Cradle

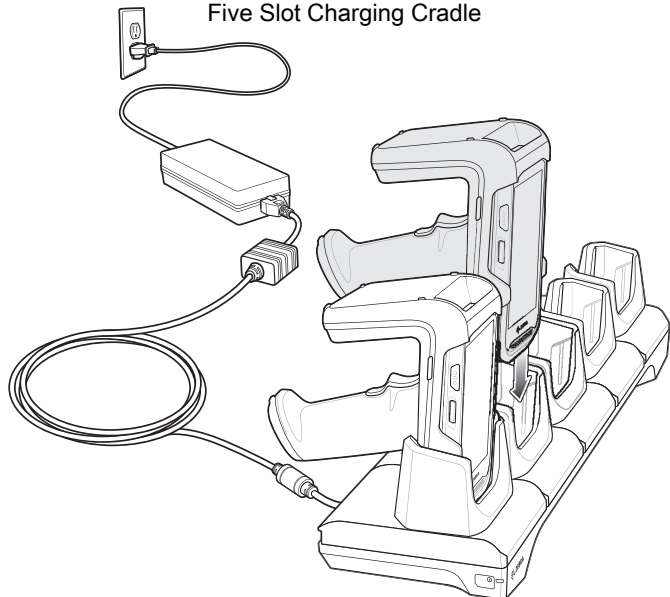

Battery Management

To check the charge status of the main battery, run the appropriate Zebra RFID Mobile application and select Settings > Battery. To check the battery status on the LEDs, remove the RFD2000 RFID Sled from the cradle. The battery charge status is displayed for 4 seconds.

In the Zebra RFID Mobile application, battery status indicates that the battery is either charging or discharging and the battery level indicates the battery charge (as a percentage of fully charged). If using the partner application, refer to the partner application documentation.

Low Battery Notification

By default, the LED battery charge status indication lasts 4 seconds when the RFD2000 RFID Sled is removed from the cradle. The indication is amber when the battery state of charge is in the range of 21-50%. The indication is red when the battery state of charge is in the range 0-20%.

The TC20 mobile device sounds four short beeps when the battery charge status is below 10%.

Battery Optimization

The RFD2000 supports intelligent performance and battery optimizations for your application needs. An API is available to enable this setting. Refer to the RFD2000 RFID Developer Guide (p/n MN-003158-xx) for more information.

Mobile Device

For detailed information regarding the TC20 Mobile Computer, refer to the TC20 User Guide, p/n MN-003020-xx at: www.zebra.com/support.

Zebra RFID Mobile Application for Android

Introduction

This chapter describes the Zebra RFID Mobile Application for Android which demonstrates RFD2000 capability and tag operation functionality.

Requirements

Requirements for the Zebra RFID Mobile Application for Android are as follows:

- The recommended Android version on the mobile computer is Nougat version 7.1.x
- Zebra Enterprise mobile computer - TC20
- Zebra RFID Manager APK
- Zebra RFID Mobile Application APK.

Installing Zebra RFID Mobile Application for Android



NOTE: The Zebra RFID Manager APK must be installed first before installing the Zebra RFID Mobile Applications.

Install the Zebra RFID Mobile Application for Android (or partner application) on the mobile computer from www.zebra.com/support. The procedure to install the software in an Android device depends on the Android version.

To install the software:

1. Connect the Android device to your computer. It should be connected as MTP Device and show as a drive on your computer. For information on transferring files using Media Transfer Protocol, refer to the TC20 Mobile Computer Integrator guide at: www.zebra.com/support.
2. Go to **Device Settings > Security** and check **Unknown Sources** to allow installation of applications from unknown sources.
3. Copy the Zebra_RFID_Mobile_API-1.0.5.xx.apk file to the mobile device.
4. Go to **Settings > Security** and select **Unknown sources**.
5. Use File Manager to locate Zebra_RFID_Mobile_API-1.0.5.xx.apk file in the folder to which its copied in [Step 3.](#), and select it.
6. In the pop-up window, select the **Android App installer** to begin installation.

Zebra RFID Mobile Application for Android

This application runs on Android mobile devices and demonstrates RFD2000 capability and tag operation functionality.

The application allows for navigating to all screens whether or not the device is connected to the RFD2000 reader. The Settings screens display the application defaults when there is no connection to the reader. When not connected, an attempt to perform any operation (Rapid Read, Inventory, Locate tag, Access Operations, Save Configuration, Battery Status) displays No Active Connection with Reader.

Navigate to all screens when the inventory/locate operation is in progress. When the operation is in progress, the device displays Operation in Progress if additional operations are initiated.

Using the Zebra RFID Mobile Application for Android

To use this application for RFID operations:

1. Ensure the Zebra RFID Mobile Application for Android is installed on the Android mobile device.
2. Launch the Zebra RFID Mobile Application for Android on the mobile device.
3. Return to the Home screen and select **Settings > Antenna**. Power Level is set to 27.0 dBm by default. Japan units are set to a different default power level depending on the SKU type.
4. Before using the device and if the region is not set, set the region in which the device is operating. To set the region, open the application and select **Settings > Regulatory** (see [Regulatory on page 34](#)).

Connecting TC20 to the RFD2000

1. Launch the demo application manually.
2. Select the **RFD2000** check box from the Readers List in Settings. The application automatically connects with the device.

When the connection is successful, the current screen populates with the values from the RFD2000.

Figure 8 Settings - Reader List / Connection Screen

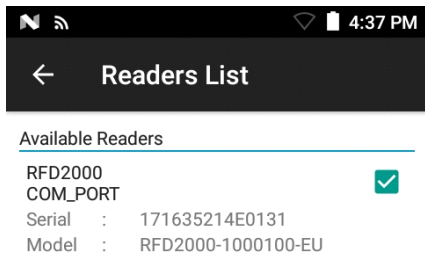

Disconnecting the RFD2000

When the RFD2000 is removed from the TC20, the application disconnects. Another option to disconnect, go to the reader list page and disconnect by unchecking the check box next to the reader.

Demo Application Screens

Home Screen

To access the Zebra RFID Mobile Application for Android, touch the **RFID Reader** icon on the mobile device to display the Home screen. Tap the **RFID Reader** icon again to display the **RFID Reader Menu**. Tap any menu item to access its screen.

Figure 9 Home and Menu Screens

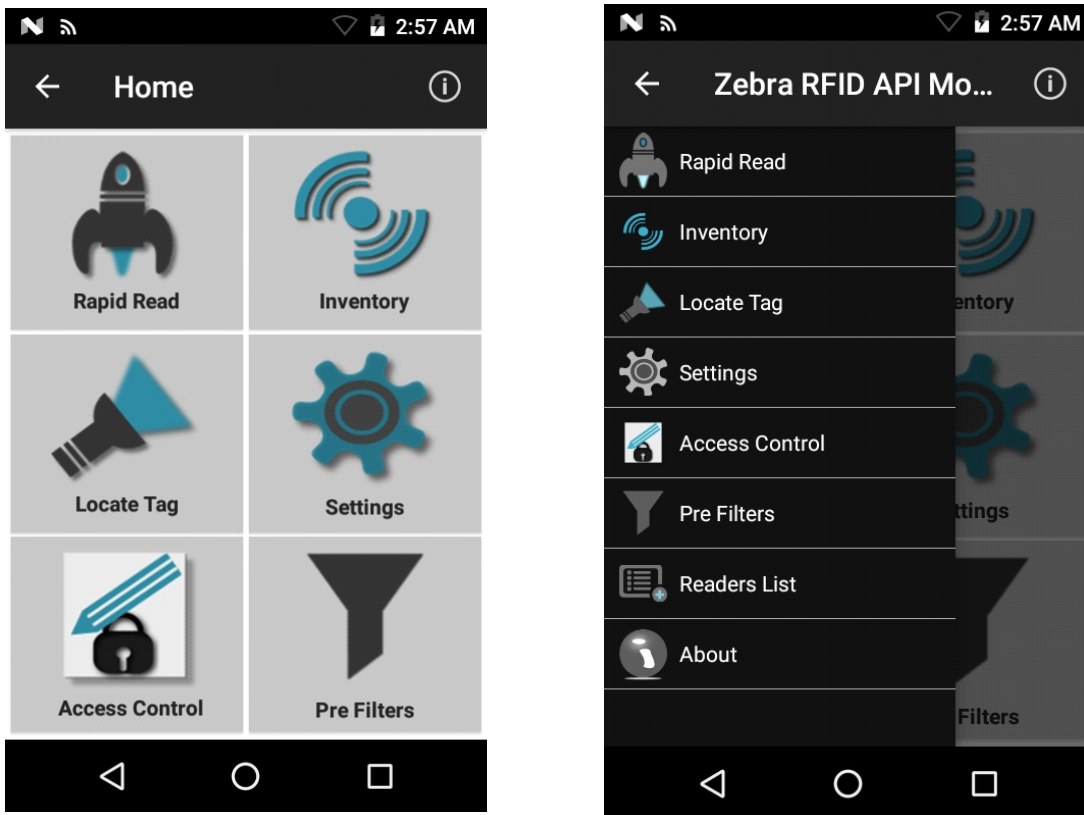

Rapid Read

Tap **Rapid Read** from the **Home** or **Menu** screen.

Figure 10 Rapid Read Screen

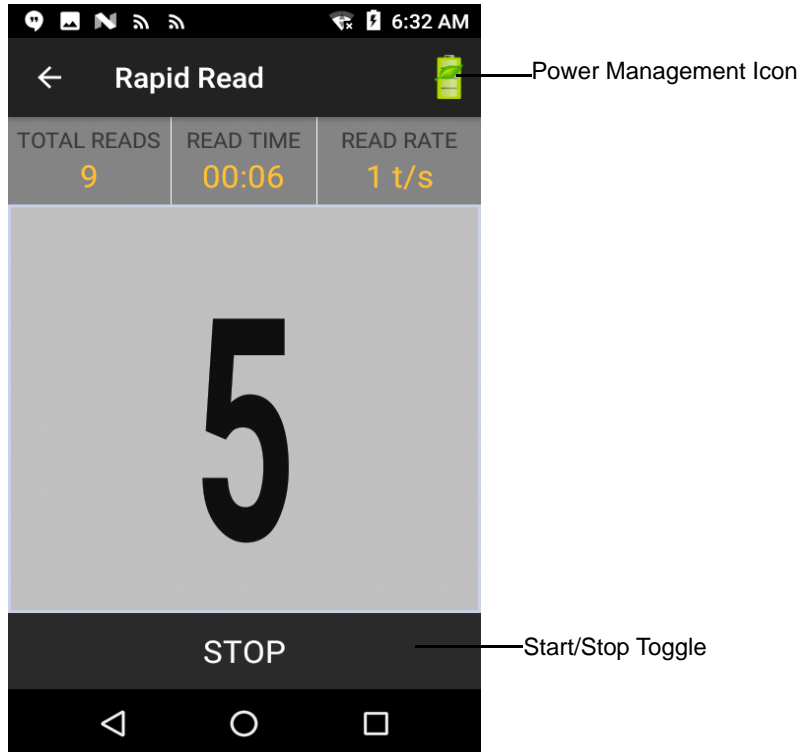

The Rapid Read and Inventory screens display the following data (see [Inventory](#) on page 24).

- Total tag count
- Read time (mm:ss)
- Tag read rate (tags/sec)
- Unique tag count (displays in the center of screen).

Rapid Read and Inventory screens are two different views of the inventory operation on the reader. The **Start/Stop** functionality can be used interchangeably on both screens. For example, when operation starts on the **Rapid Read** screen and you navigate to the **Inventory** screen, the button available on the **Inventory** screen is **Stop**. The same is true when the operation starts on the **Inventory** screen. During the rapid read process, you can navigate to the **Inventory** screen to view tag details along with tag counts for each tag. The statistics displayed are maintained on the **Rapid Read** and **Inventory** screens regardless of the screen used to start the process.

Select **Start** to start the rapid read inventory operation. Select **Stop** to stop inventory operation.



NOTE: The scan trigger on the RFD2000 can also start and stop the inventory operation. Press the trigger to start, and press again to stop.

Moving to another screen does not halt the operation. However, attempting to make changes or perform another operation while rapid read is in process results in an error.

Inventory

Select **Inventory** from the **Home** or **Menu** screen.

Figure 11 Inventory Screen

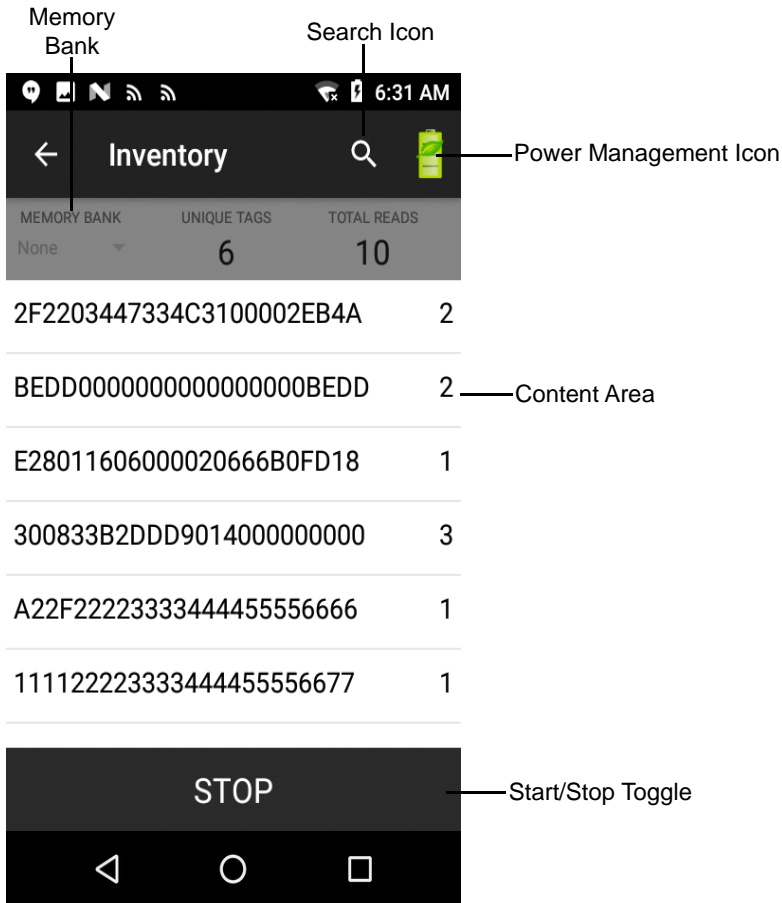

Tag reading is started and stopped on this screen as well as on the **Rapid Read** screen (see [Rapid Read on page 23](#)). When the process starts, tag information displays on the screen.

Select **Start** to start the rapid read inventory operation. The **Start** button changes to **Stop**. Tap **Stop** to stop the read inventory operation.



NOTE: The scan trigger on the RFD2000 can also start and stop the inventory operation. Press the trigger to start, and press again to stop.

The tag ID selected displays on the **Locate Tag** screen when navigating to that screen (see [Locate Tag on page 26](#)).

Inventory Screen Features

Table 6 Inventory Screen Features

Item	Description
Action Bar	
Tags	<p>Tap Memory Bank to select one of the following memory bank options from the drop-down menu:</p> <ul style="list-style-type: none"> • None - Defaults to EPC. • User - Allows reading user memory bank data when the tag is inventoried. • Reserved - Allows reading reserved memory bank data when the tag is inventoried. • TID - Allows reading TID memory bank data when the tag is inventoried. • EPC - Allows reading EPC memory bank data when the tag is inventoried. When the next inventory operation starts, the details from the selected memory bank displays. This menu is inactive if there is an ongoing operation on the connected reader. • Default Display - None.
Search	Tap the Search icon and enter a tag ID. Tags that match the entry display in the content area.
Power Management	Icon indicates if Dynamic Power is on. See Power Management on page 36 . Tap the Power Management icon to open the Battery Status screen.
Content Area (select a tag)	Tapping a Tag ID highlights the tag. The highlighted Tag ID is populated on the Tag Location text area as well as the Tag Pattern area in the Access Control screen. Tap Start to start searching for the tag. See Locate Tag on page 26 for more details. From this screen, return to the Menu or go to the Home screen and select Locate Tag .
Content Area (select a tag)	<p>The tags displayed in this area are based on the option selected from the memory bank. Tap the tag ID to expand details about the tag. Tap the tag ID again to collapse details.</p> <p>Example Default Tag Display:</p> <p>Tag ID Tag Count AD99 15404190725965400404</p> <p>Example Expanded Tag Display:</p> <p>Note: Expanded tag detail can only display when the inventory operation is stopped. Memory bank data is shown only when inventory is complete.</p> <p>Tag ID Tag Count AD99 15404190725965400404 EPC MEMORY3000 RSSI -50 Phase 1800 USER 1122334455667788AABBCCDDEEFF 1122334455667788AABBCCDDEEFF 1122334455667788AABBCCDDEEFF</p>

Locate Tag

Tap **Locate Tag** from the **Home** or **Menu** screen.

Figure 12 Locate Tag Screen

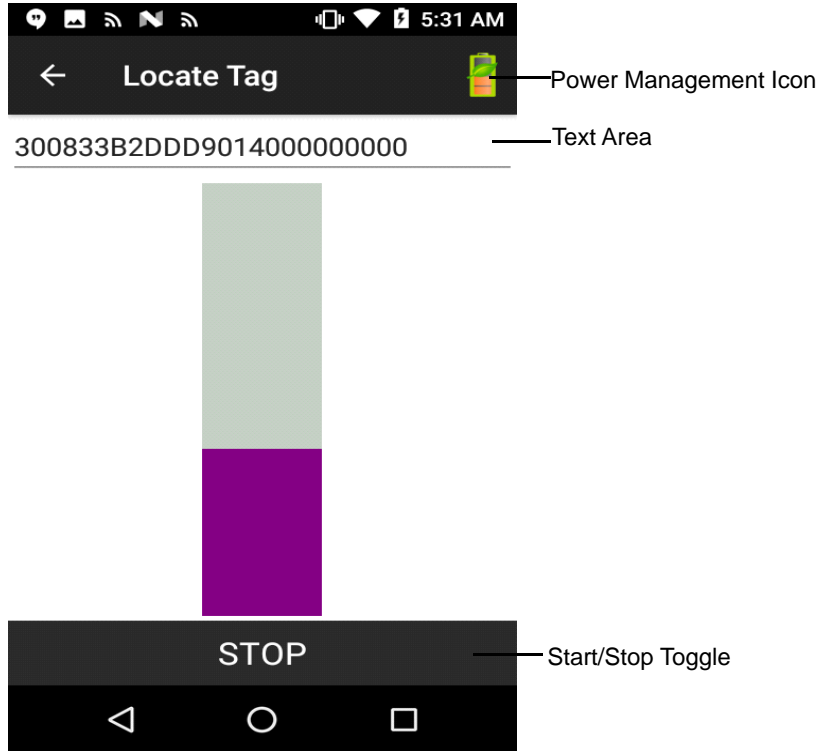

On this screen, enter the Tag ID in the text area or select a tag from the Inventory screen to pre-populate the Tag ID to search.

Tap **Start** to start the locate tag operation. Tap **STOP** to stop. The RFD2000 trigger can also be used to start and stop the operation.



NOTE: The scan trigger on the RFD2000 can also start and stop the inventory operation. Press the trigger to start, and press again to stop.

The color bar on the display shows the relative distance of the tag.

When the locate tag operation starts, moving to another screen does not stop the operation until **Stop** is selected.

Settings

Figure 13 Settings Screen

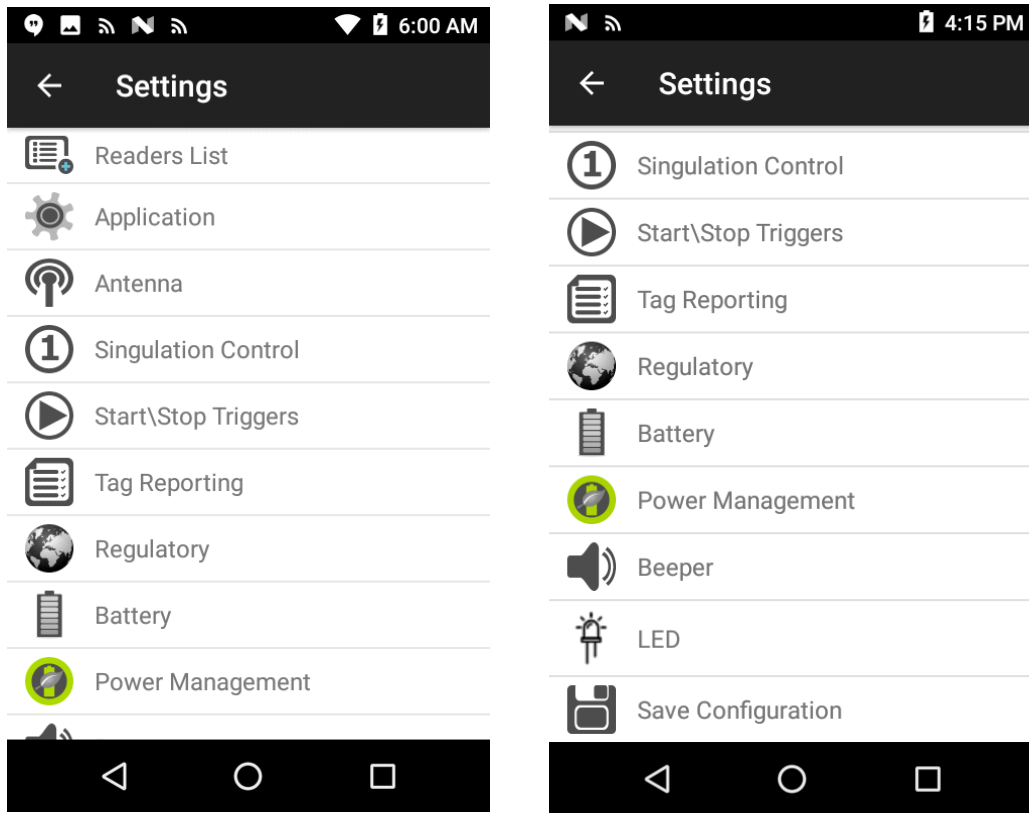

Table 7 Settings Screen Options

Settings Option	Description	Page
Readers List	Displays connected RFD2000 RFID.	5-28
Application	Displays reader connection, notification, and data export settings.	5-29
Antenna	Displays antenna power lever and link profile.	5-30
Singulation Control	Displays Session, Tag Population, Inventory State and SL Flag.	5-31
Start\Stop Triggers	Allows Start and Stop button control.	5-32
Tag Reporting	Support for reporting unique tags as part of tag reporting options.	5-33
Regulatory	Allows region and channel selections.	5-34
Battery	Displays the RFD2000 battery status.	5-35
Power Management	Turns Dynamic Power Optimization on and off.	5-36

Table 7 Settings Screen Options (Continued)

Settings Option	Description	Page
Beeper	Use to turn the beeper on/off, and set volume.	5-37
LED	Enables/Disables TC20 tag read LED indicator.	5-37
Save Configuration	Ability to save all settings: Antenna, Singulation, Tag Reporting, Start/Stop trigger, Beeper Volume, and Regulatory. Note: The settings are also automatically saved when changes are made.	5-38

Readers List

From the **Settings** screen, select **Readers List**.

Figure 14 Settings - Readers List Screen

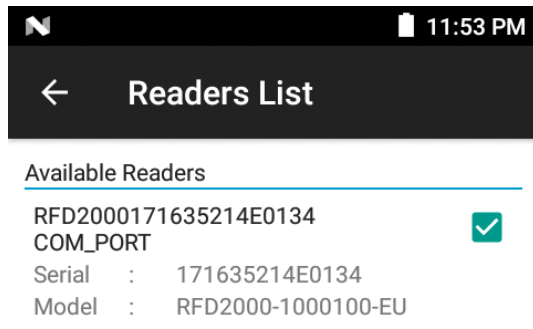

Tap a reader name from the **Readers List** to establish a session with the selected reader. Tap again to terminate the session.

Application

From the **Settings** screen, select **Application**.

Figure 15 Settings - Application Screen

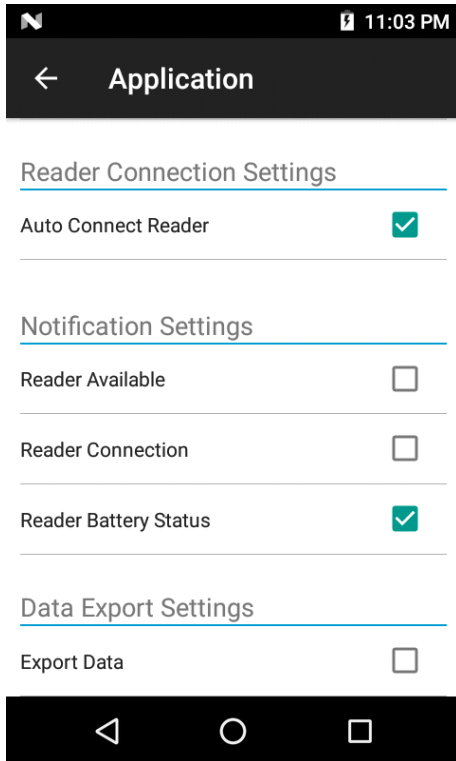

The application always detects the RFD2000 reader that is attached to the TC20 Mobile Computer.

- **Auto Reconnect Reader** - When checked, the application attempts to reconnect to the reader.
- **Export Data** - When checked, the application writes the inventoried RFID data to a file when the inventory operation stops. On Android platforms the file is saved in a fixed directory. Check the files in file browsing in the Inventory directory (Sdcard/inventory/<files>). The files may be copied to a PC.

Antenna

Figure 16 Settings - Antenna

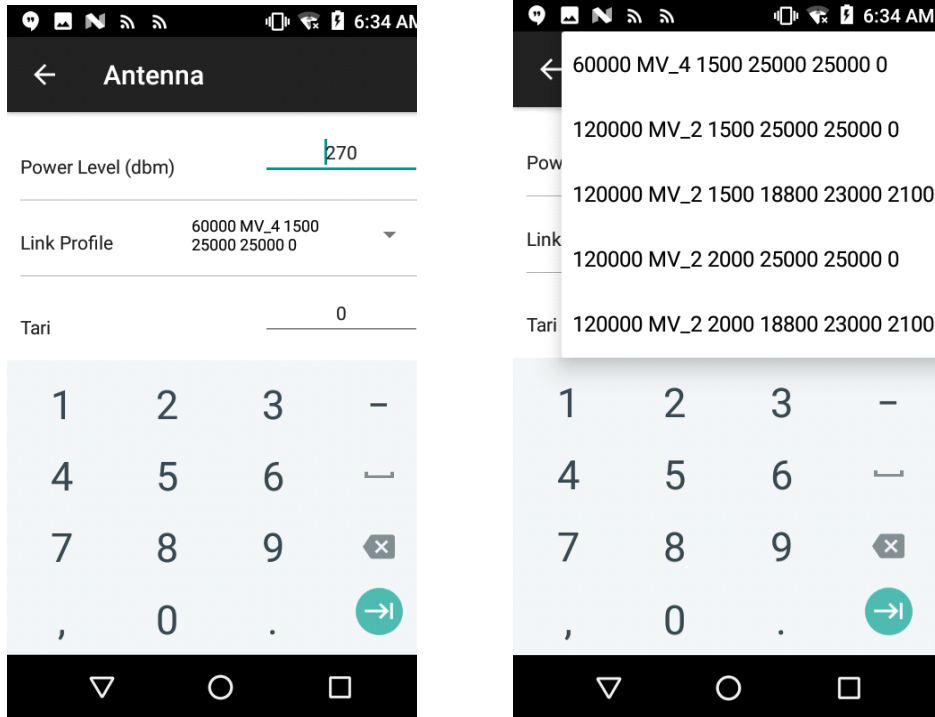

The Antenna screen displays the following:

- **Power Level** displays the current selection and includes a drop-down list of available power levels (as reported by RFD2000). 27.0 dBm is the default setting, and it is shown as 270 because the value used is in units of tens of dBm. Japan units are set to a different default power level depending on the SKU type.

The minimum power level when DPO is enabled is 3.1 dBm. When DPO is disabled, the minimum power level is 0 dBm.

- **Link Profile** displays the current selection and includes a drop-down list of available link profiles (reported by RFD2000).

Link Profile display format is as follows: Return link bit data rate in bis per second (e.g., 60000 -> 60 Kbs); Miller Value (e.g., MV_4 -> Miller 4); modulation type (PR ASK is the only one supported); PIE value has no units and is either 1.5 or 2 (e.g., 1.5 -> 1500 and 2 -> 2000); minimum Tari value in thousands of micro seconds (e.g., 6250 -> 6.25 microseconds); maximum Tari value in thousands of micro seconds; Tari step value in thousands of micro seconds. If the step value is zero, then Tari is fixed for this link profile. If the step size is non zero, then the default Tari value is the minimum value.

- The **Power Level** and **Link Profile** are blank when there is no connection to the reader.

Singulation Control

Figure 17 Settings - Singulation Control

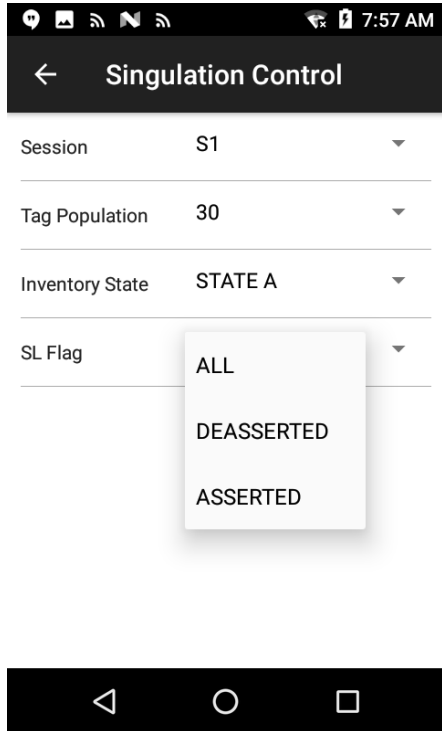

View/configure the singulation control settings for each antenna.

- **Session** - The drop-down list includes the available options (S0, S1, S2, S3).
- **Tag Population** - A numeric value of the estimated number of tags in the Field of View (FOV). Values shown are 30, 100, 200, 300, 400, 500, 600.
- **Inventory State** - State A & State B, AB FLIP.
- **SL flag** - ALL, DEASSERTED, ASSERTED.

All values can be selected from the drop-down lists.

Start\Stop Triggers

Figure 18 Settings - Start/Stop Triggers

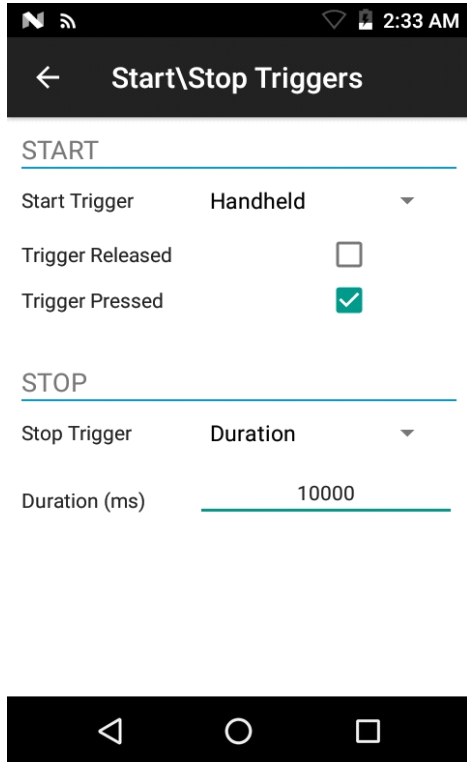

The **Start Trigger** Periodic displays the Period input box (in milliseconds).

The **Stop Trigger Duration**, **Tag Observation** and **N attempts** displays numeric value input boxes. All time entries are in milliseconds.

All the required details for saving triggers to the reader must be entered or the application does not save the trigger settings to the reader.

Required input for Start/Stop Trigger settings are as follows:

- **Start Trigger**
 - **Immediate**
 - **Hand-held** - Select either the **Trigger Pressed** or **Trigger Released** check box.
 - **Periodic** - Enter the period of time in milliseconds.
- **Stop Trigger**
 - **Immediate**
 - **Hand-held** - Select either the **Trigger Pressed** or **Trigger Released** check box along with **Timeout** in milliseconds.
 - **Duration** - Enter duration in milliseconds.
 - **Tag Observation** - Enter the tag count along with timeout in milliseconds.
 - **N Attempts** - Enter the number of attempts along with timeout in milliseconds.

If the start trigger type is Hand-held trigger (pressed or released), the application sets the repeat for the operation to ensure the use case if repeated operations can be demonstrated.

if any trigger is defined as Hand-held, then the application does not act on immediate trigger type for a Hand-held trigger action.

Tag Reporting

Figure 19 Settings - Tag Reporting

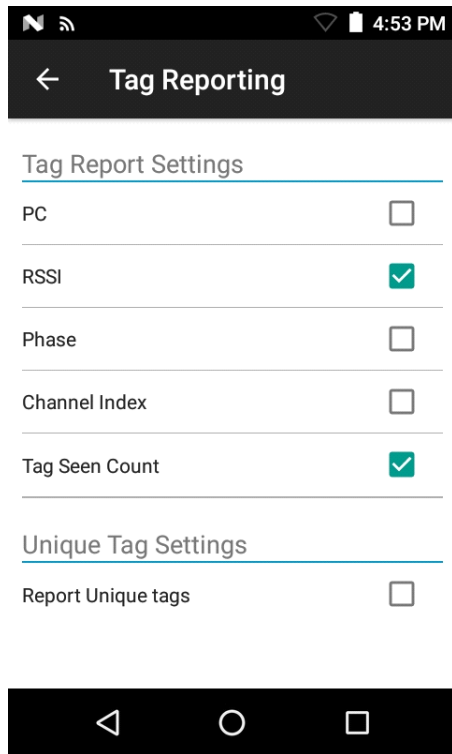
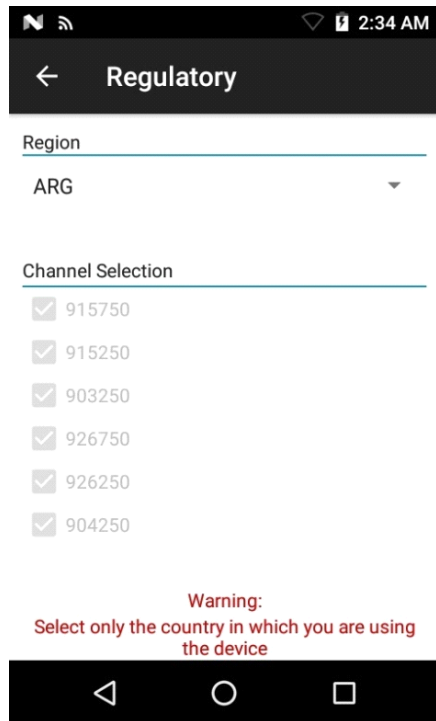

Table 8 Tag Reporting Screen Options

Option	Description
PC	Select to allow reporting the PC as part of the Tag Data.
RSSI	Selection indicates whether or not the RSSI (Received Signal Strength Indication) is reported as part of the Tag Data.
Phase	Select to indicate whether or not the Phase is reported as part of the Tag Data.
Channel Index	Select to indicate whether or not the Regulatory Channel Index is reported as part of the Tag Data.
Tag Seen Count	Select to indicate whether or not the Tag Seen Count is reported as part of the Tag Data.
Report Unique Tags	When this option is enabled, the reader reports only unique tag reads. The Unique Tag reporting feature can be enabled when using Tag List Match mode.

Regulatory

Figure 20 Settings - Regulatory



The region drop-down displays the current region to which the device is set. Choose the correct region before using the device.

- **Channel Selection** is allowed only for the regions that allow channel setting.
- Supported regions are reported by the RFD2000.
- If the region is not configured on the RFD2000, the **Regulatory** screen is the first screen displayed after connecting to the RFD2000.



NOTE: Select only the country in which you are using the device.

Battery

Figure 21 Settings - Battery

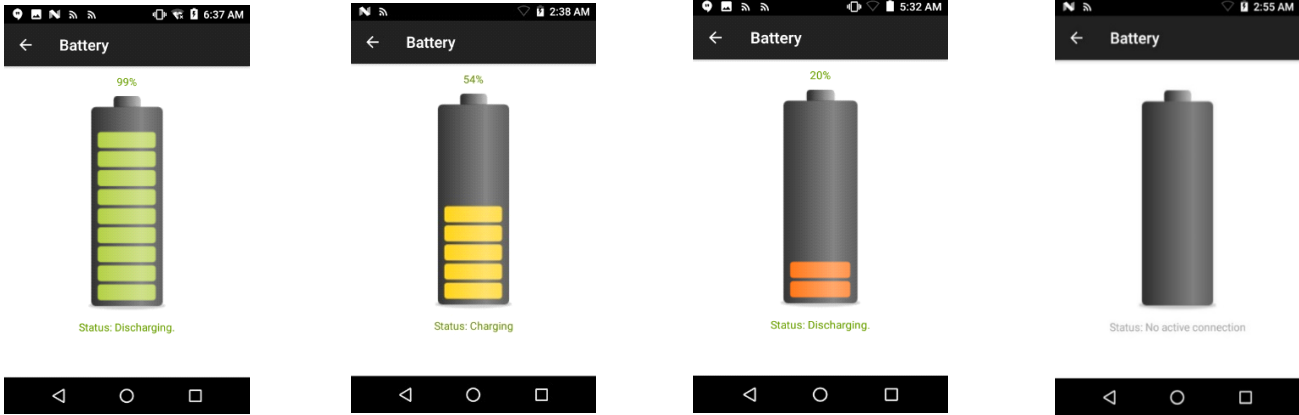

This screen displays the status of the battery in the RFD2000 RFID Sled. The battery levels are as follows:

- Level is high (in green) Status - Battery is fairly charged
- Charging/Discharging Status
- Critical (in red) Status - Battery Level is Critical
- Low (in orange) Status - Battery Level Low
- Reader is not connected (in grey) - No Active Connection.

Power Management

Figure 22 Settings - Power Management

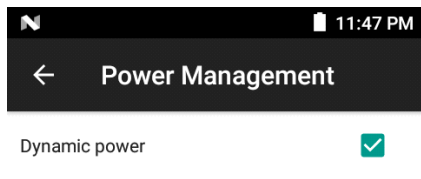

Dynamic Power optimization configures the reader for best battery life and works with Pre configured settings. Dynamic Power optimization works only for inventory operation



This screen provides an option to enable **Dynamic Power Optimization (DPO)** in the reader. Enabling DPO enhances battery life during inventory operations.



NOTE: DPO is enabled by default. It is not necessary to disable DPO when executing access operations or using filters because DPO is automatically disabled and when the operation is complete, it is automatically enabled.

If **Dynamic Power** is On, a green battery icon appears in the title bar of the application. Tapping on this opens the **Battery Status** screen.

Beeper

Figure 23 Settings - Host Beeper

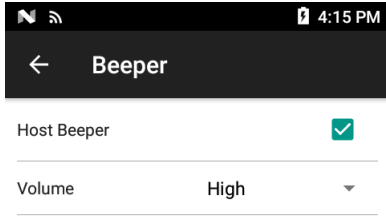

This screen displays the current **Host Beeper** settings. Turn the beeper Off by un-checking the **Host Beeper** check box, or set the volume to **High**, **Medium** or **Low**.

The mobile computer provides a beep indication for inventory and access operations.

LED

Figure 24 Settings - Host LED

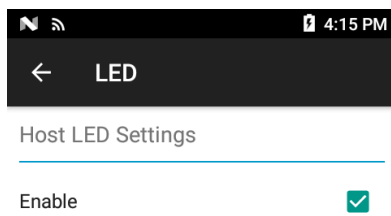

This screen displays the current **Host LED Setting**. Select the check box to enable the mobile computer LED. During inventory and access related operations, the LED blinks green for a successful read.

Save Configuration

Figure 25 Settings - Save Configuration

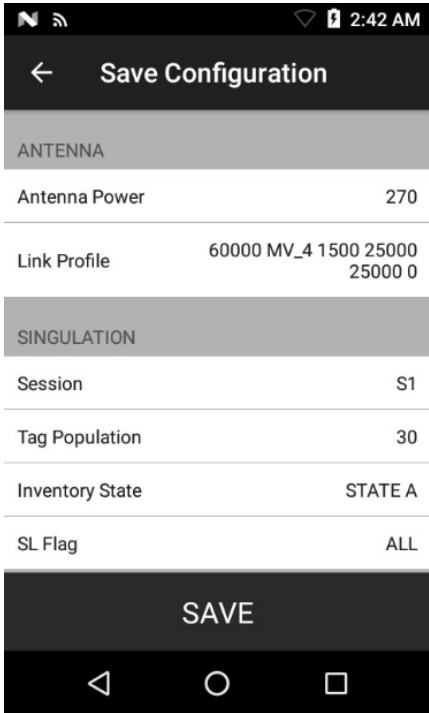

This screen is used to save the settings and displays the current settings on the RFD2000.

The settings are saved on RFD2000 until a reset to factory defaults is performed on the unit (see [Settings on page 27](#)).

The Tag Pattern area is automatically filled in when a tag is selected in the Inventory screen.

Access Control

Figure 26 Access Control Screens - Read/Write, Lock, Kill

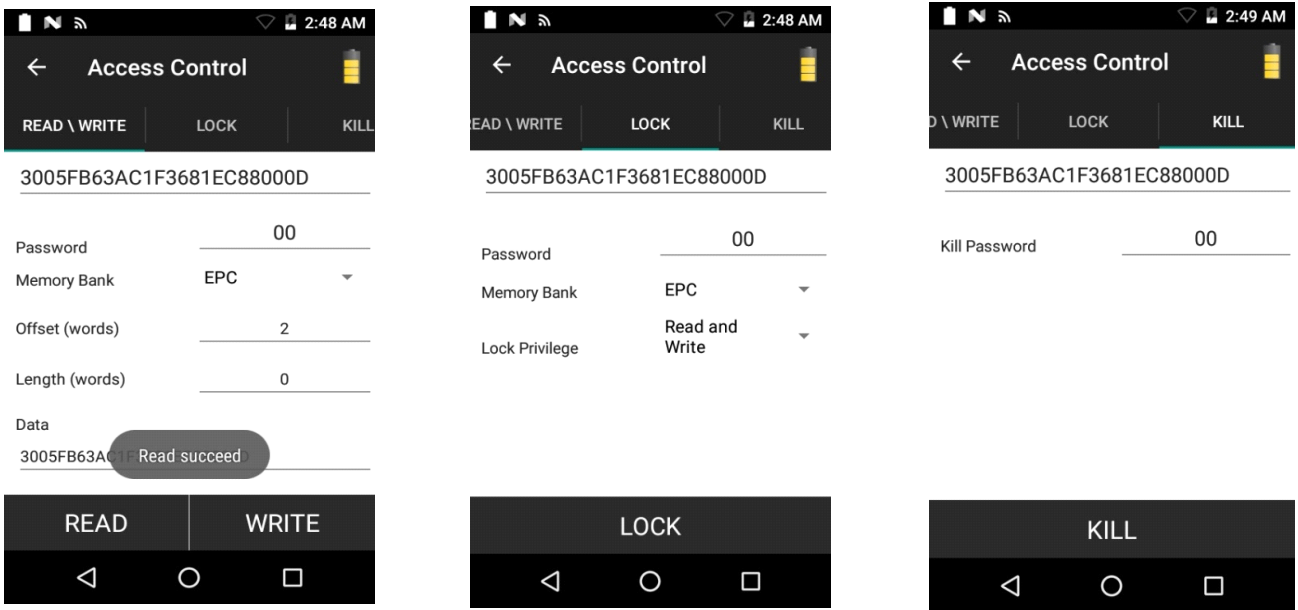

The Tag Pattern area is automatically filled in when a tag is selected in the Inventory screen.

Read/Write

Read/Write options are:

- Tag ID & Password values are in hex. Tag ID is edited
- **Memory Bank options** - EPC, RESERVED, TID and USER
- **Offset** and **Length** values are in 16-bit words
- **Access operation** screen maintains edited tag ID.

Lock

Lock privilege options are as follows:

- **Read and Write**
- **Permanent Lock**
- **Permanent Unlock**
- **Unlock.**

Kill

Permanently renders the tag unusable. A **Kill Password** must be provided.

Pre Filters



NOTE: DPO must be disabled from the Power Management screen to allow **Pre Filters** functionality. See [Power Management on page 36](#).

Figure 27 Pre Filters Screen

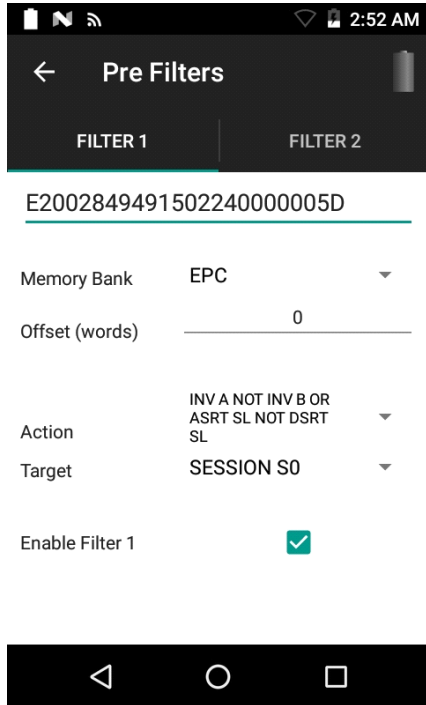

Options

Up to two of the following Pre Filters may be enabled.

- **Memory Bank** - EPC, TID and USER.
- **Offset** - Offset in the memory bank is specified in words.
- **Action:**
 - INV A NOT INV B or ASRT_SL_NOT_DSRT_SL
 - INV A or ASRT SL
 - NOT INV B or NOT DSRT SL
 - INV A2BB2A NOT INV A or NEG SL NOT ASRT SL
 - INV B NOT INV A or DSRT SL NOT ASRT SL
 - INV B or DSRT SL
 - NOT INV A or NOT ASRT SL
 - NOT INV A2BB2A or NOT NEG SL
- **Target** - SESSION S0, SESSION S1, SESSION S2, SESSION S3 & SL FLAG.

About

Figure 28 About Screen

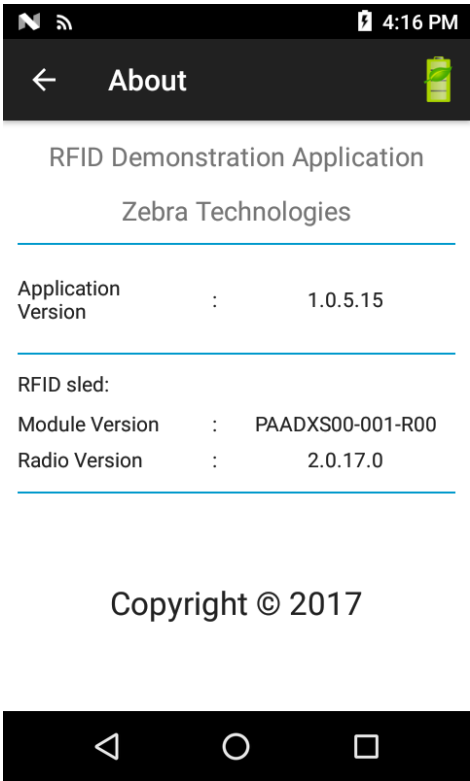

This screen displays version information as reported by the RFD2000.

RFID Manager

Introduction

The Zebra RFID Manager application supports management of the TC20 Android mobile device that is used with the RFD2000. It provides the ability to navigate to all screens whether or not the device is connected to the RFD2000 reader. The **Settings** screens display the application defaults when there is no connection to the reader.



NOTE: Some screens shown in this guide may differ from the actual screens shown on the device. Screens are subject to change with future releases.

Setting Up the RFD2000

To start using the RFD2000 for the first time with the TC20:

- Ensure the battery is installed
- Charge the RFD2000
- Power on the RFD2000
- Attach the RFD2000 to the TC20
- Set the region and power level (using the RFID Manager Application, Demo Application, or the partner application).

Installing RFID Manager for Android

Requirements

- TC20 Zebra mobile computer
- The recommended Android version on the mobile computer is Nougat version 7.1.x.

Installation

To install the software:

1. Connect the Android device to your computer. When the android device is connected to the PC, setup USB as the file transfer mode and the device displays as a storage device on your computer. For information on transferring files using Media Transfer Protocol, refer to the TC20 Mobile Computer Integrator guide at: www.zebra.com/support.
2. Copy the Zebra_RFID_Manager-1.0.7.xx.apk file to the mobile device.
3. Go to **Device Settings > Security** and check **Unknown Sources** to allow installation of applications from unknown sources.
4. Use **File Manager** to locate the Zebra_RFID_Manager-1.0.7.xx.apk file and select it.
5. The installer window displays. Select the Android App installer to begin installation.

Using the RFID Manager for Android

To use this application for RFID operations:

1. Ensure the Zebra RFID Manager application for Android is installed on the TC20 mobile device.
2. Launch the Zebra RFID Manager application for Android on the mobile device.
3. Connect the RFD2000.
4. Before initial use, set the region in which the device is operating. To set the region, open the application and select **Settings > Regulatory**.



NOTE: If the RFID Demo application or partner application is connected to the RFD2000, the RFID Manager application does not display real time information and does not allow you to change settings such as, regulatory, reset reader, reset factory defaults, and firmware updates.

Connection Status

Reader Connection Status

If the TC20 is not connected to the RFD2000:

1. Launch RFID Manager manually.
2. On the **Home** screen under **Connection Status> Reader**, it indicates if the RFD2000 is **Attached** or **Detached** to the TC20.
3. The RFID Manager application attempts to connect with the reader once it is attached. If the reader is Off, a notification window displays. To turn the RFD2000 On, press the trigger for 1.3 seconds and release.
4. If no client is connected, the RFID Manager displays the battery status and regulatory.

Figure 29 Reader Connection Status Screens

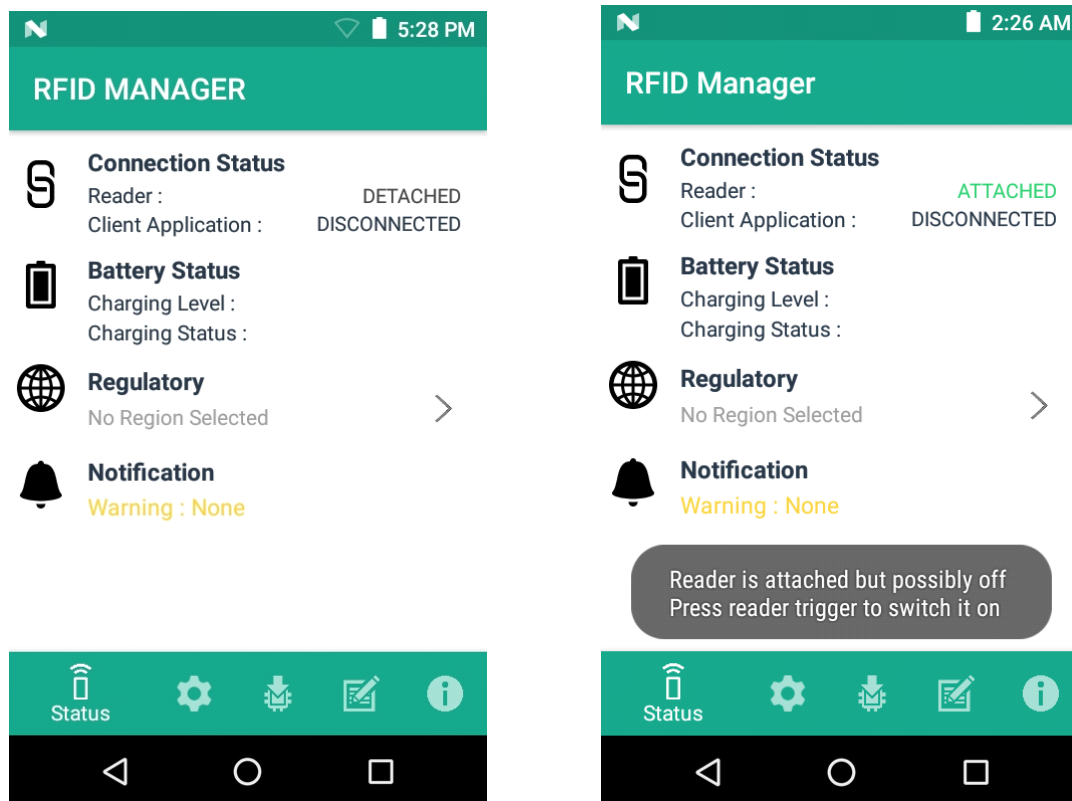

Client Application Status

If the TC20 is connected to the RFD2000:

1. Launch the application manually.
2. On the **Home** Screen under **Connection Status > Client Application**, it indicates if the client application is **Connected** or **Disconnected** to the RFD2000.

Figure 30 Client Application Status Screens

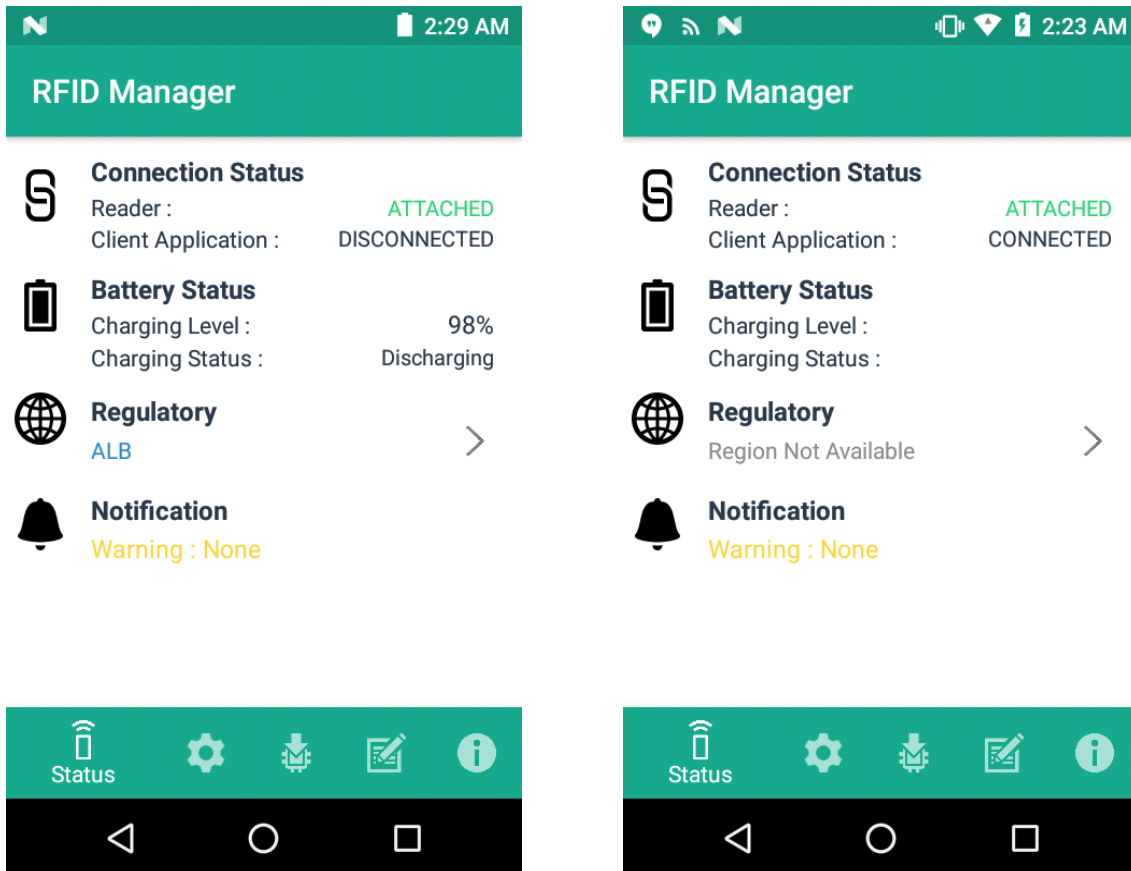

The **Battery Status** contains the battery **Charging Level** percentage and the **Charging Status** (Charging or Discharging). When the **Client Application** is connected, the **Battery Status** fields is blank.

When **Client Application** is connected, the **Regulatory** field is blank.

RFID Regulatory

To set the region, select the **Regulatory** arrow button to open the **Regulatory** screen. Select the **Region** and **Channel Selection** settings and tap the **Apply** button. The **Region** drop-down displays the current region to which the device is set. Choose the correct region before using the device.



NOTE: The **Region** and **Channel Selection** requires setup before the initial use only. However, if a **Reset to Factory Defaults** operation is conducted on the RFD2000 RFID Sled, the operation removes the **Region** and **Channel** configuration and needs to be reset.



NOTE: Select only the country in which you are using the device.

- **Channel Selection** is allowed only for the regions that allow channel setting.
- Supported regions are reported by the RFD2000.
- If the region is not configured on the RFD2000, the Regulatory status will show as NA.
- A customer application can also set the region and configuration pragmatically.

Figure 31 Regulatory Screens

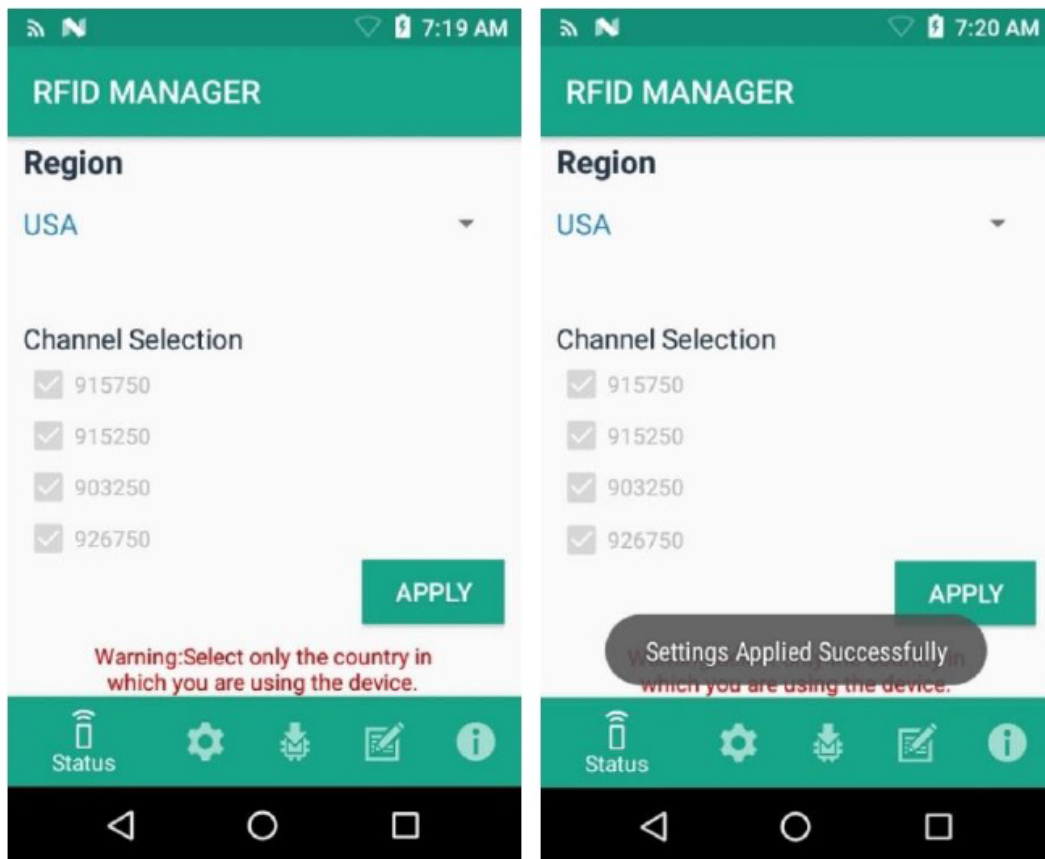

Settings

To display Settings, select the **Settings** icon located on the bottom tool bar.

To edit notification control and reader reset functionality, select the **Settings** control button. Setting options are as follows:

- **Battery Notification** – If enabled, a low battery notification appears with the battery level indication.
- **Battery Beep Notification** – If enabled, a low battery beep notification is heard from the mobile computer.
- **Temperature Notification** – If enabled, a temperature high and critical notification appears with temperature level indications.
- **Reader Attach / Detach notification** – If enabled, notifications are generated when the reader is attached and connected or when reader is detached.
- **Auto Firmware Update** - If enabled, and when the device is attached to the mobile computer, firmware update starts automatically with the firmware stored in the application cache, if there is a version mismatch.

Figure 32 Settings Screen

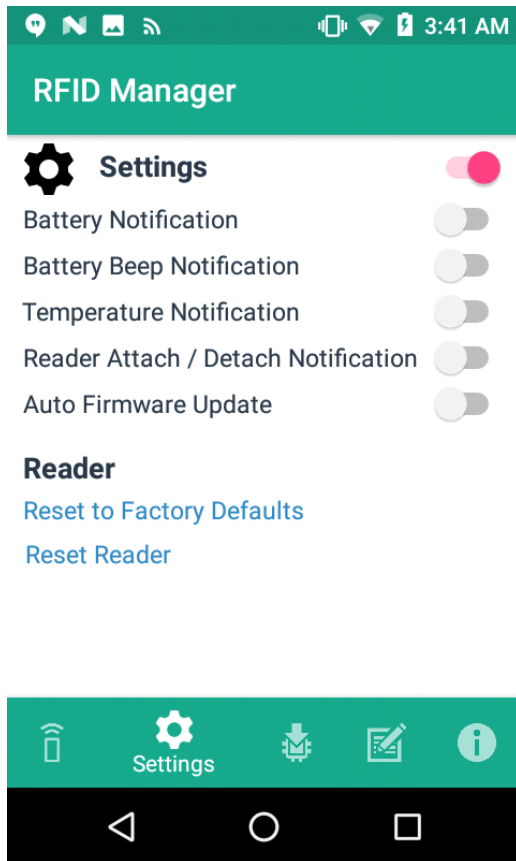

- **Reset to Factory Defaults** - Select **Reset to Factory Defaults** to reset all configuration and region settings to factory default settings. When selected, the reader reboots and a window message displays after successful operation. Reader status confirmation is located under **Home > Status**.

Figure 33 Reset to Factory Defaults Screen

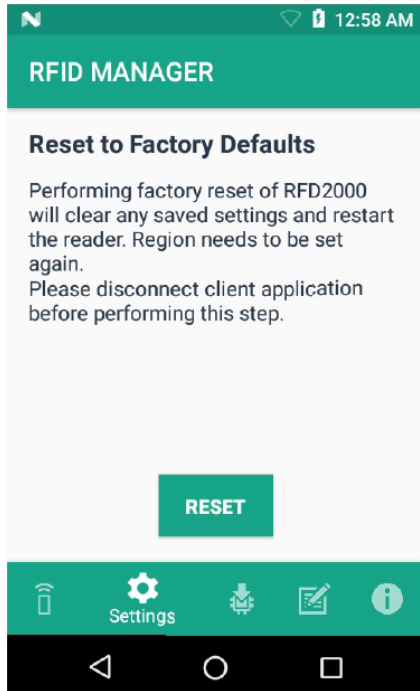

- **Reset Reader** - Select **Reset Reader** to perform a reader restart. When selected, the reader reboots and a window message displays after successful operation. Reader status confirmation is located under **Home > Status**.

Figure 34 Reader Reset Screen

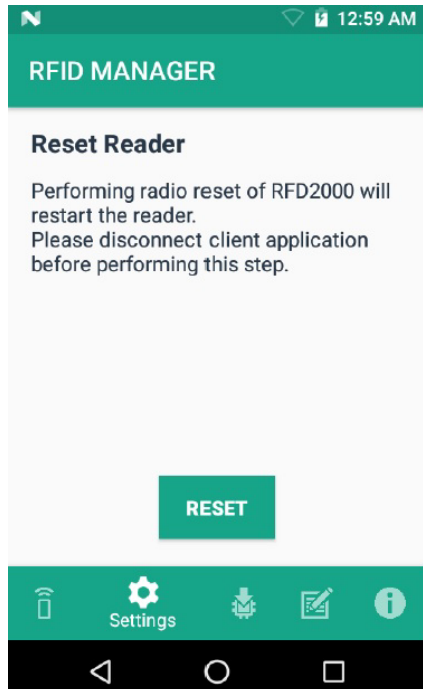

Firmware Update

A product code update, bootloader, and radio update may be performed using the firmware update screen.



NOTE: When the RFID Management application is launched for the first time, a dialog box appears for permission to allow access for internal storage. To perform a firmware update, access must be allowed.



NOTE: More than 20% battery level is required to perform a Firmware Update.

To perform a firmware update:

1. Copy the DAT or SCNPLG file into the TC20 SD card. Refer to the Transferring Files Using Media Transfer Protocol section of TC20 Mobile Computer Integrator guide at: www.zebra.com/support.
2. Browse for the firmware DAT or SCNPLG file, either super combined image or individual files by selecting the folder icon.
3. Select the required DAT or SCNPLG file from **File View** menu. When the file is selected, the application returns to update screen.

Figure 35 Transferring Files for Firmware Update

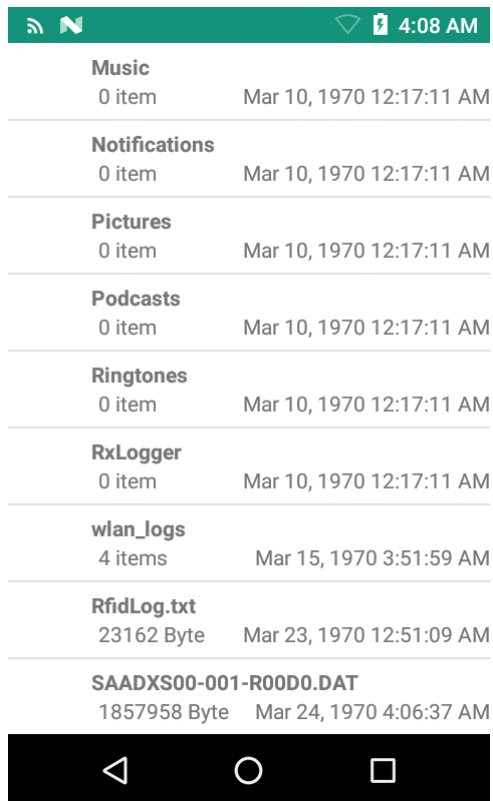

- Select **UPDATE**.

Figure 36 RFID Manage Firmware Update Screen

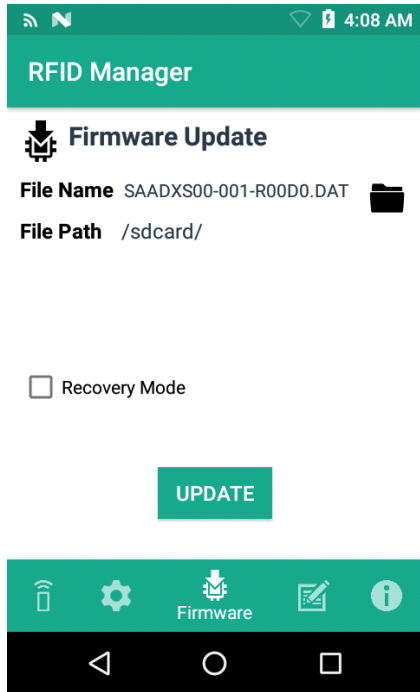

- The progress is shown with progress dialogues for RFID Radio, bootloader, and RFD2000 when a super combined image is used. A single progress dialogue is shown if an individual image file is used.
- After a successful update, a window displays a RFD2000 Firmware Installation Complete message.

Figure 37 Firmware Update Progress Screen

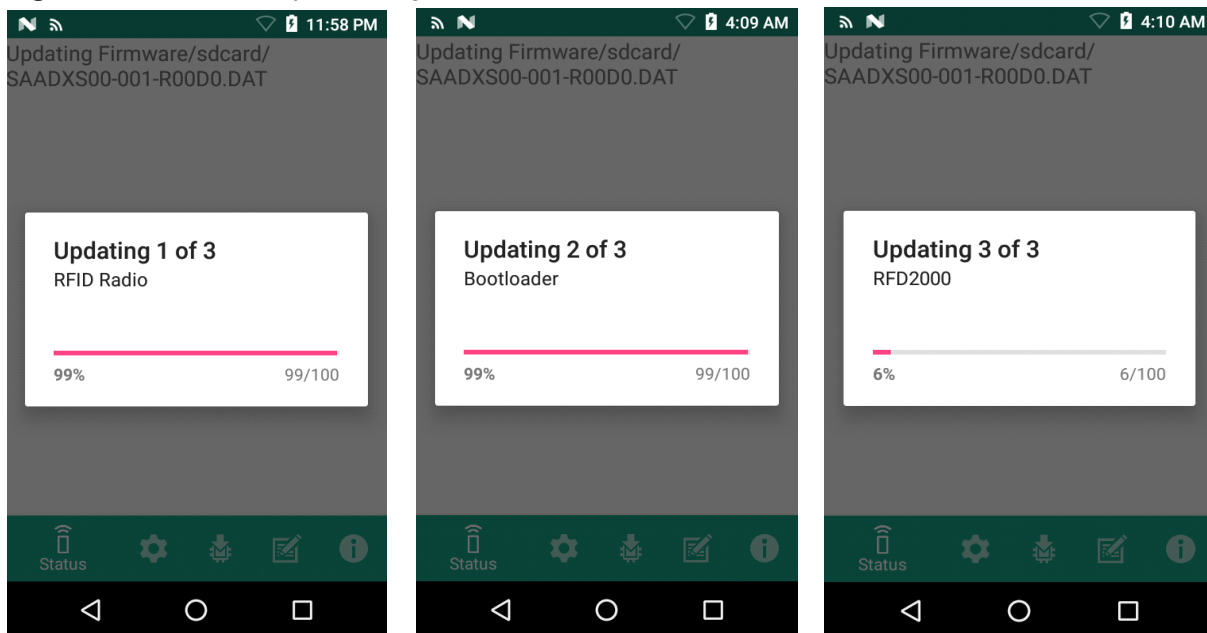

The updated firmware information is displayed on the Information screen.

Figure 38 Information Screen

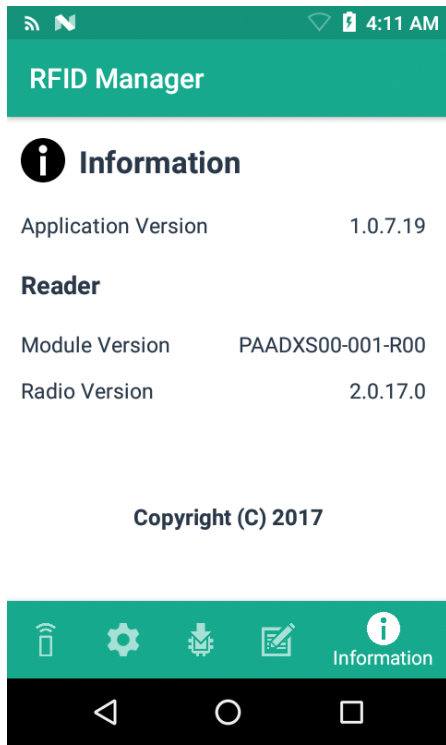

Recovery Mode

Only select the **Recovery Mode** check box (see [Figure 36 on page 50](#)) if the RFD2000 firmware is suspected to be corrupted. Contact the Zebra support team to use the Recovery Mode option.

RFID Manager Log

The following options may be enabled to capture reader logs.

- **Real-time Logs** - Captures real time logs from the RFD2000.
- **Retrieve Buffered Logs** - Captures the buffered logs from the RFD2000.
- **Debug Logs** - Captures RFID Manager debug logs.



NOTE: All three logs can be enabled. If all three logs are disabled, default logs from the application is captured which does not include RFD2000 logs.

Figure 39 RFID Manager Logger Screen

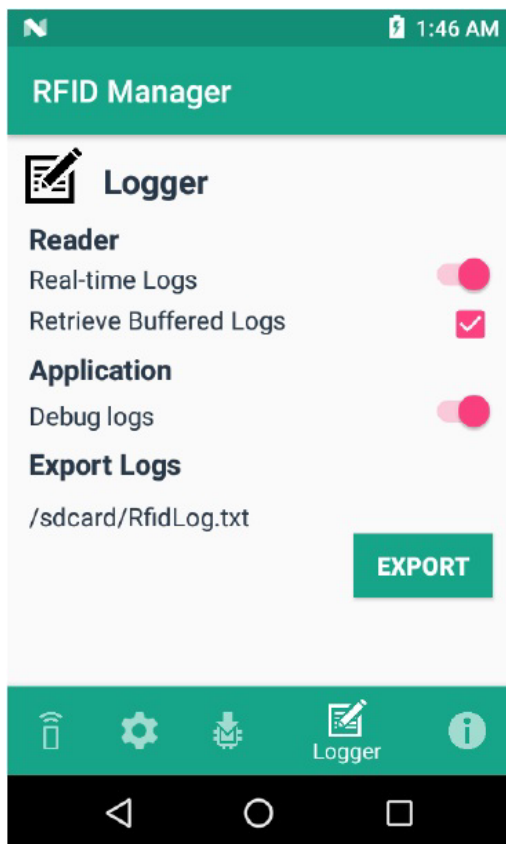

To capture real time logs:

1. Enable **Real-time logs**.
2. Connect and use the RFID application to create logs.
3. Tap on **Export** to retrieve the real time logs. It is not required to disconnect or exit the RFID application.

The Retrieve Buffered Logs option can only be used if the RFID application is disconnected or not running.

The standard RX Logger application can also be used to get RFIDAPI3 and RFIDSERVICE activity.

Exporting Log Files

To export captured log files, select the **Export** button. The log file is saved as RfidLog.txt at a root of the TC20 file system. Retrieve the log file after connecting with PC. RfidLog.txt file is located in the internal storage of the root folder.



NOTE: If the client is connected, RFID Manager allows exporting of debug logs only. Dump logs cannot be retrieved.

Beeper Indications

The RFID Manager application provides beeper indications on TC20 for the following:

- Low battery alert
- Charging start indication.

About

The **About** screen displays the RFID Manager **Application Version**, **Reader Module**, and **Radio Version** as reported by the RFD2000.

Figure 40 About Screen

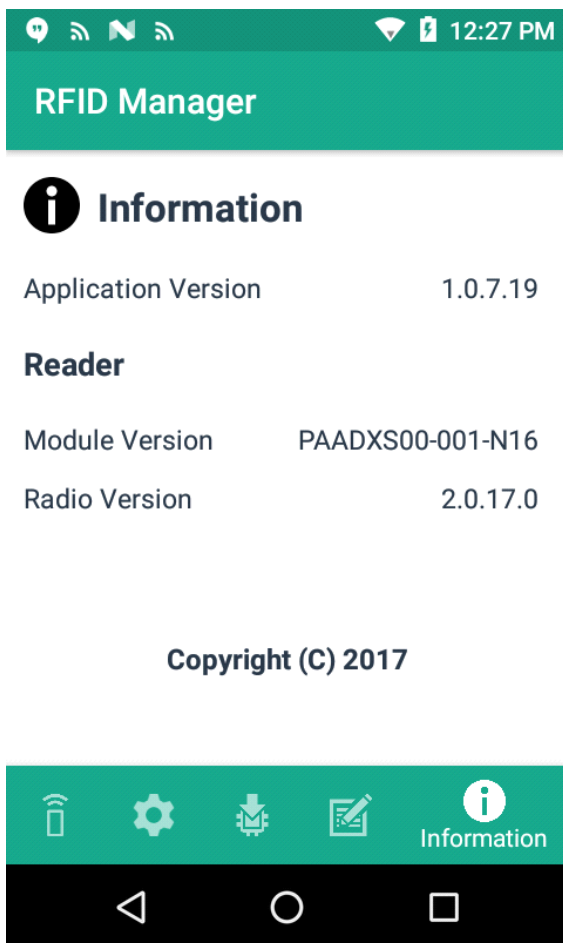

Copyright (C) 2017

RFID Scan-Scan-Write

Introduction

The Zebra Scan-Scan-Write application demonstrates the use case of using the Android Mobile Device with the RFD2000 to program tags. The application showcases the typical use case of scanning the UPC & EPC barcodes and uses the information to write the unique EPC ID to the tag.

The application works with UPC-12/14 (GTIN12 & GTIN14) barcode for company prefix and item identifier. The Serial number is derived from temporary EPC tags scanned.

Application Usage and Screens

1. Upon launch of the Scan-Scan-Write application, a list of devices displays. Choose the device and tap **Select Device**. After auto connection with RFD2000, the reader name displays.

Figure 41 Connect to Select Device

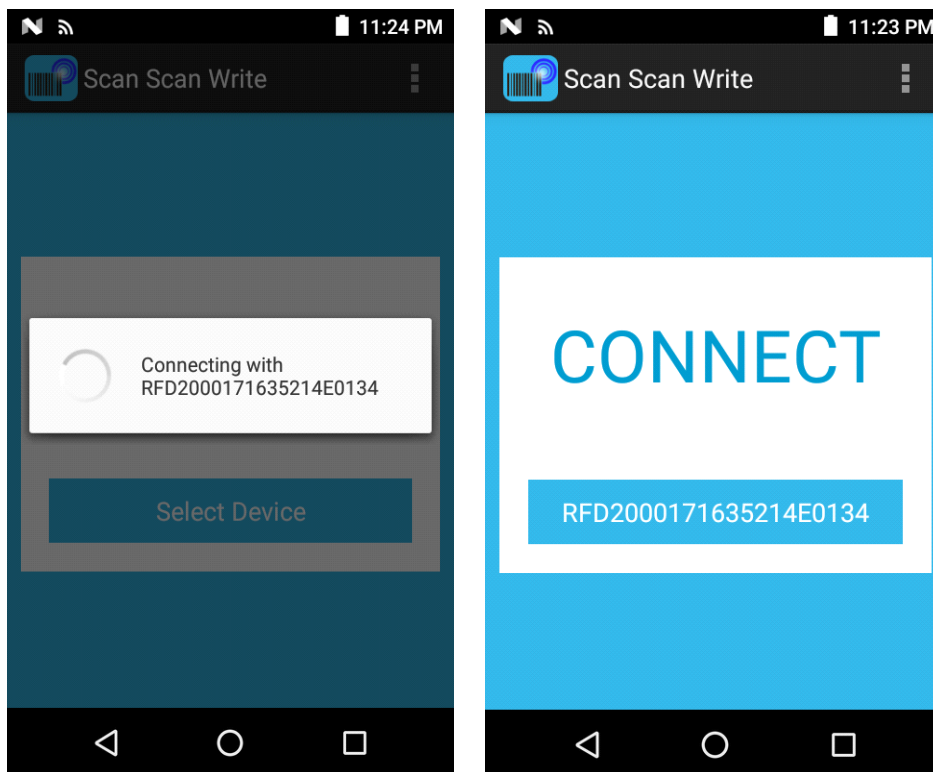

2. Tap on Overflow icon on the action bar, which leads to available readers and displays enumerated scanner device and RFD2000 reader name with connection status. To disconnect with the RFD2000, uncheck the desired check box.

Figure 42 Available Readers Screen

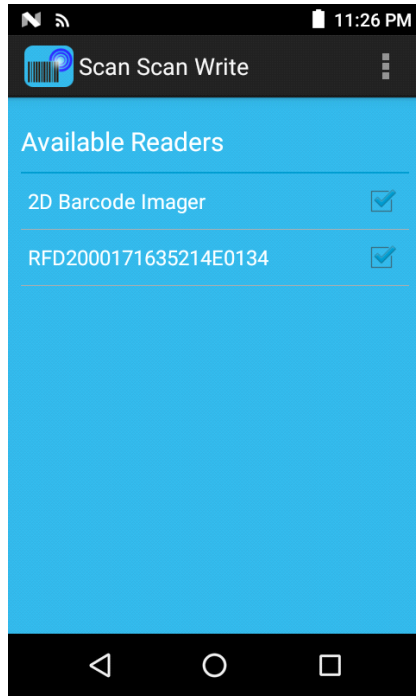

3. Upon successful connection with the reader, the application automatically displays the **Scan UPC Barcode** screen.

Figure 43 UPC Barcode Screen

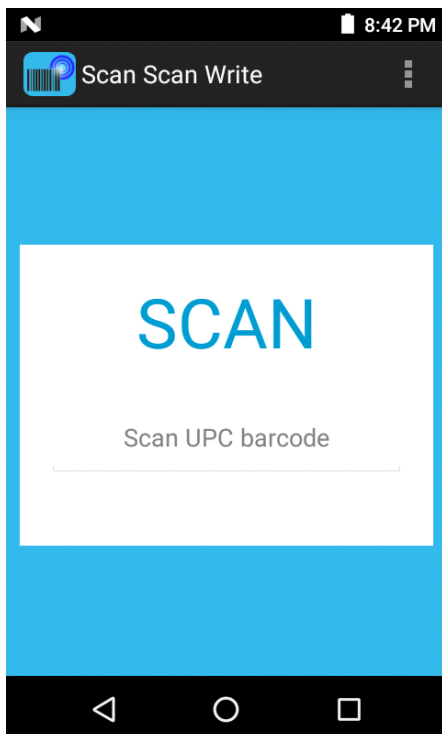

4. Scan the UPC barcode. The EPC barcode screen displays.

Figure 44 UPC Barcode Scanned Screen

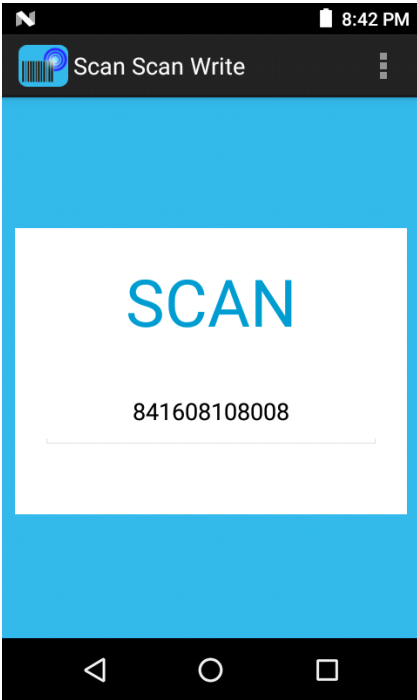

5. Upon successful scan of the EPC application, the write screen displays for writing of generated SGTIN96 EPC Tag ID.

Figure 45 EPC Barcode Scan Screen

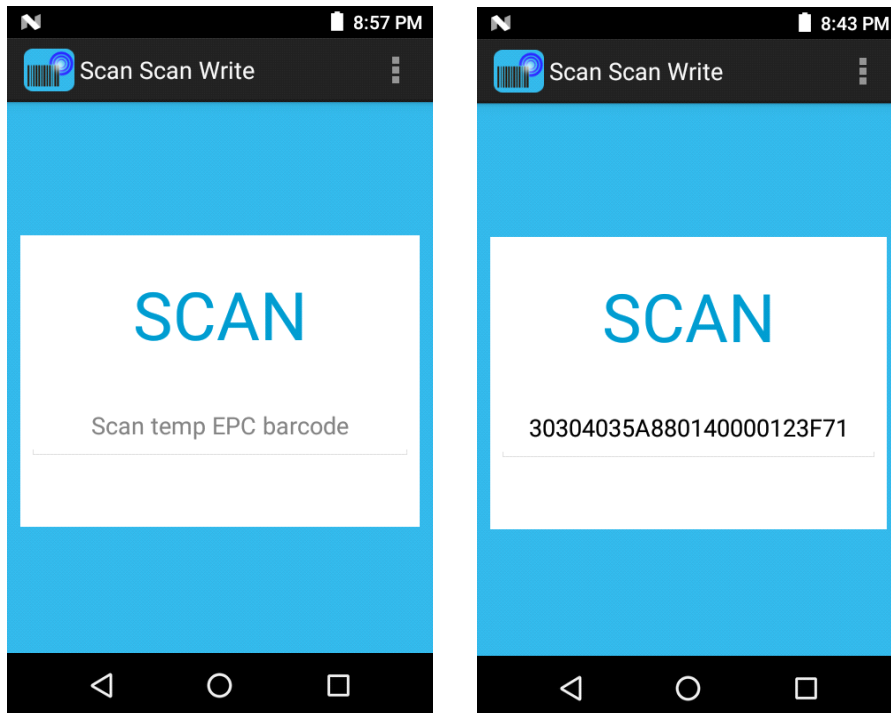

6. A notification of **Write Success** or **Access No Response From Tag** message displays.
7. Tap on **Encode Next Tag** to continue.

Figure 46 Tag Read Notification Screens

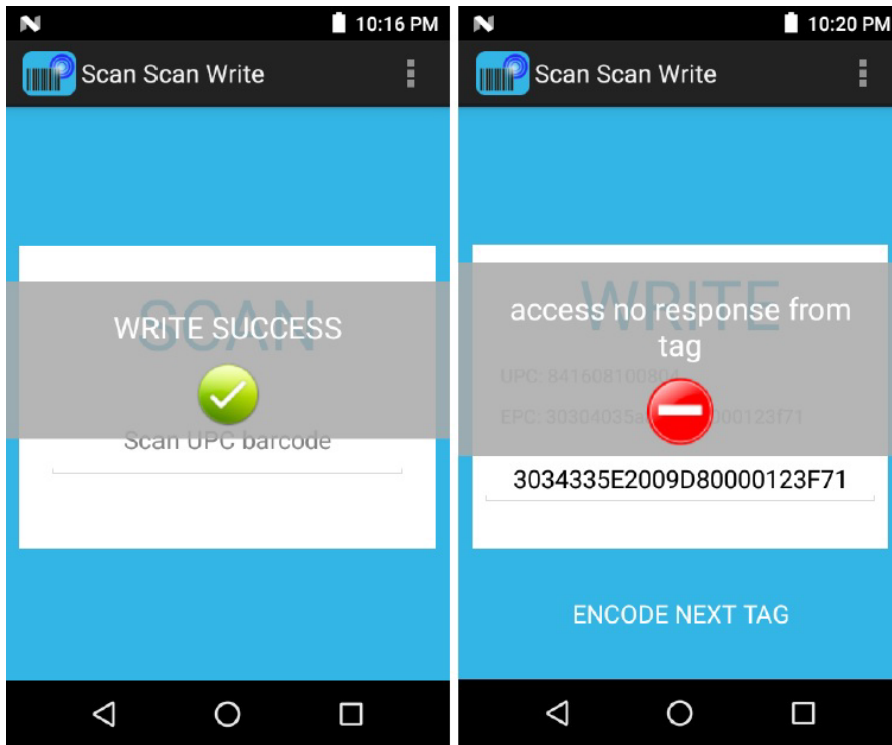

Settings

Select the overflow icon in the bottom toolbar to display the setting options.

- Reader List of available readers
- **Power Level** - Power changes are currently not supported. The write operation is performed at maximum value.
- **SGTIN96** - The application considers filter and partition value in edit text box while formatting SGTIN96 EPC tag ID.

Figure 47 Setting Screens

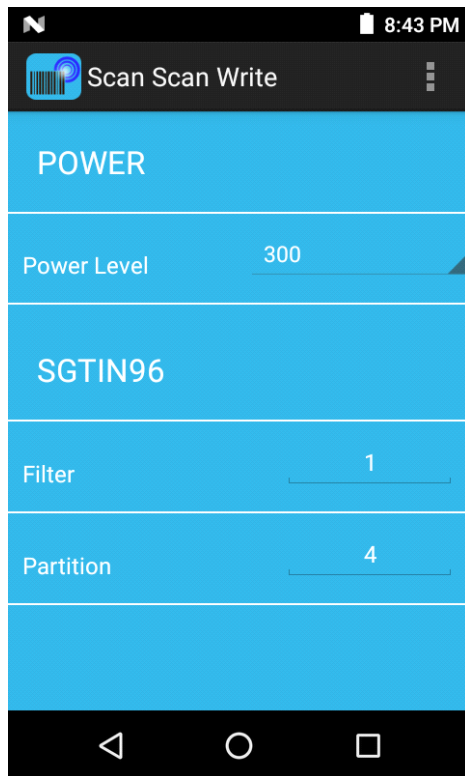

StageNow

StageNow Staging Solution

Zebra Technologies' StageNow allows any size organization to easily stage a handful or thousands of Android devices with a quick scan of a barcode or tap on an NFC tag. StageNow provides an easy Wizard-based tool that allows even complex Staging profiles to become simple to create.

The StageNow Installation Guide provides instructions for installing, uninstalling, and upgrading the StageNow Staging Solution, and includes information on versions, compatibility, and system requirements. Refer to the StageNow Installation Guide and firmware at: www.zebra.com/support.

RFID Manager StageNow Plug-in

Introduction

This chapter provides the steps necessary to configure StageNow to update the RFD2000 firmware and configuration. It also provides the steps to import the RFID CSP plug-in into the StageNow app and generate various profiles for firmware updates and reader configurations.

Requirements



NOTE: The plug-in was tested with StageNow versions 2.9.1.1279 and 2.9.1.1328.

- RFD2000 StageNow plug-in: RFD2000-StageNow-Plugin-v1.1.zip
- StageNow v2.9
- RFD2000 firmware in DAT format (SAADXS00-001-R04D0.DAT) or RFD format (RFD2000-SAADXS00-001-R04.RFD). These files can be downloaded from the Zebra RFD2000 Support site at: www.zebra.com/us/en/support-downloads/software/firmware/rfd2000-firmware.html
- Staging server configured with StageNow
- TC20 with RFD2000 RFID Manager version 1.0.7.22



IMPORTANT: Before using StageNow, prepare the TC20 to stage the RFD2000 by running the RFID Manager at least one time so that it registers the CSP plug-in properly.

Importing RFID Manager CSP Plug-in

To import RFID Manager CSP plug-in into the StageNow application:

1. Open the **StageNow** application.
2. Select **CSP Library**.

Figure 48 Import RFID Manager - CSP Library Selection

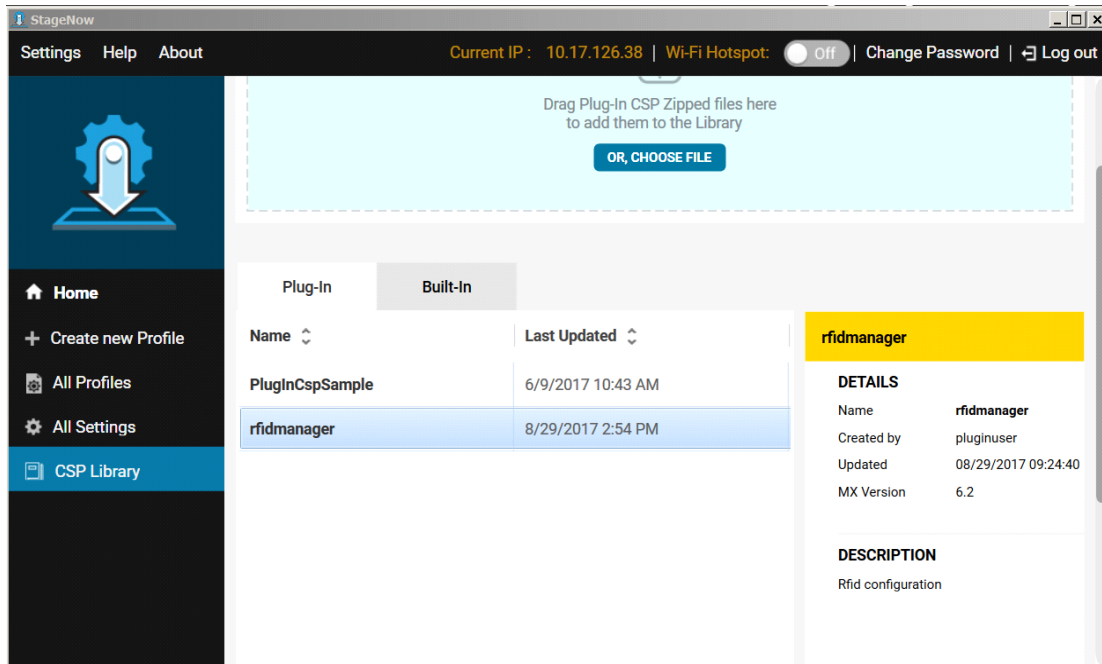

3. Select **CHOOSE FILE**.
4. Browse the RFD2000-StageNow-Plugin-v1.1.zip.

Figure 49 Plug-in CSP Successful Upload Window

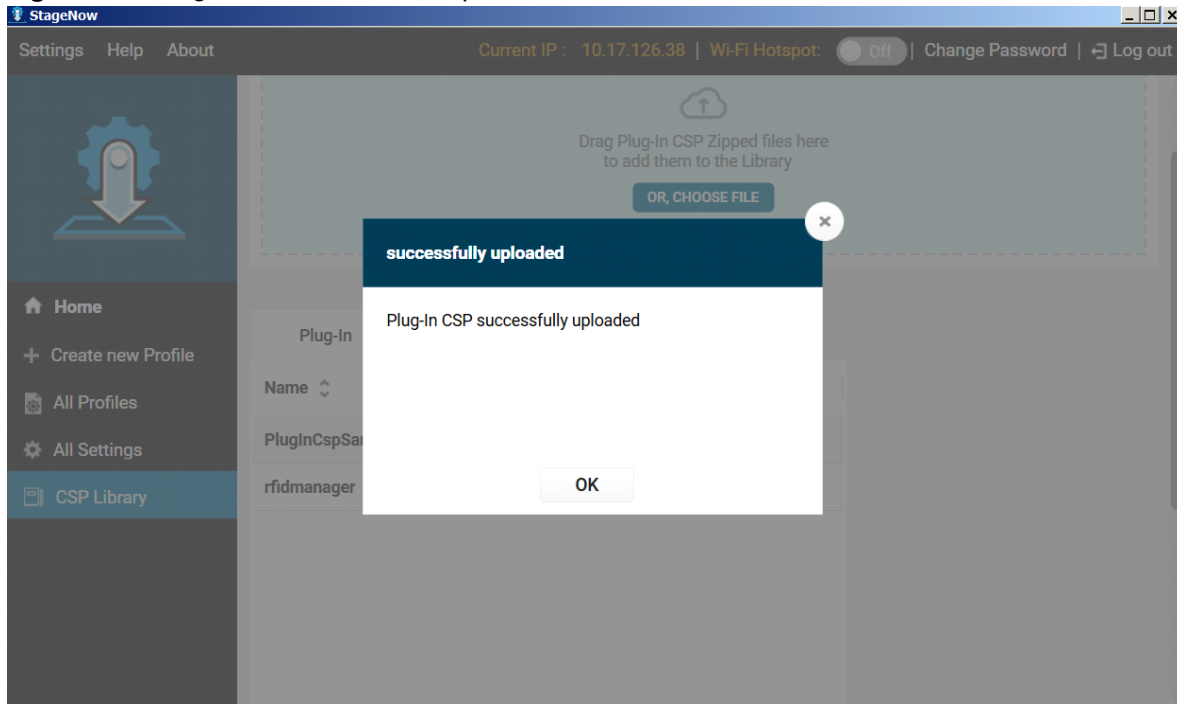

5. When the upload of the .zip file successfully completes the RFID Manager entry displays (Figure 50).

Figure 50 RFID Manager Last Updated Entry

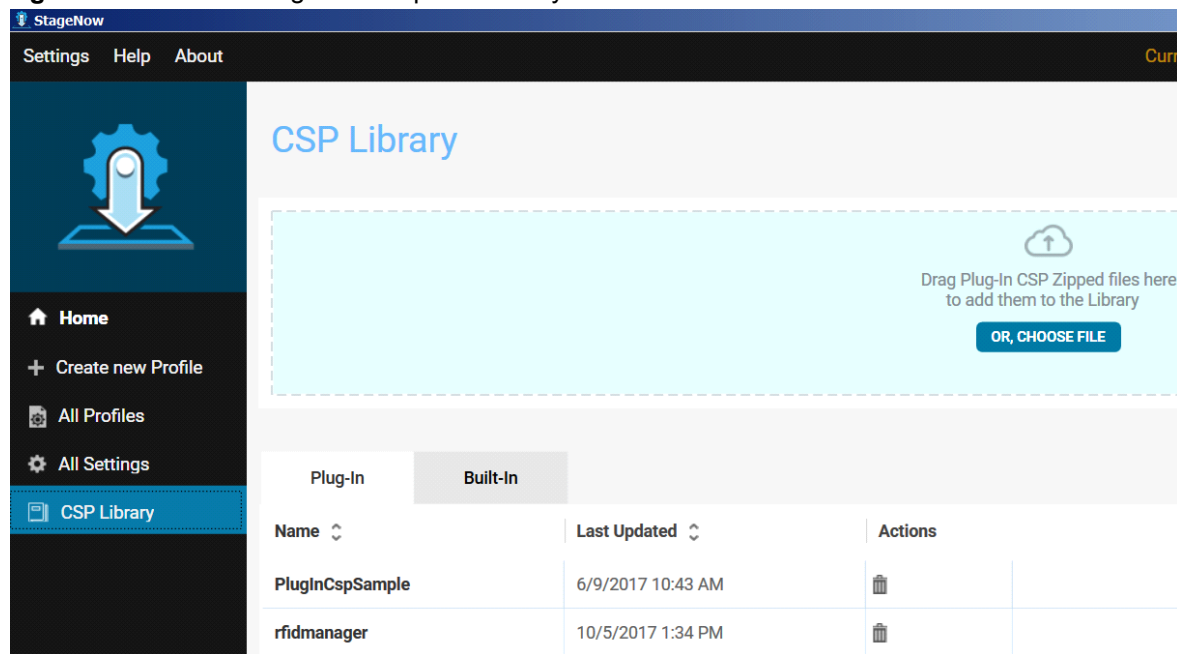

Creating Firmware Update Profile Using StageNow

This section provides the steps to create a new firmware profile. The example that follows creates a profile to copy the SAADX00-001-N10D0.DAT file from the staging server to the device and then update the firmware.

To create a new firmware profile:

1. Ensure both the staging device and the staging server are connected and accessible through the network.
2. Select **Create new Profile** from the side menu.

Figure 51 Create Firmware Update - CSP Library Screen

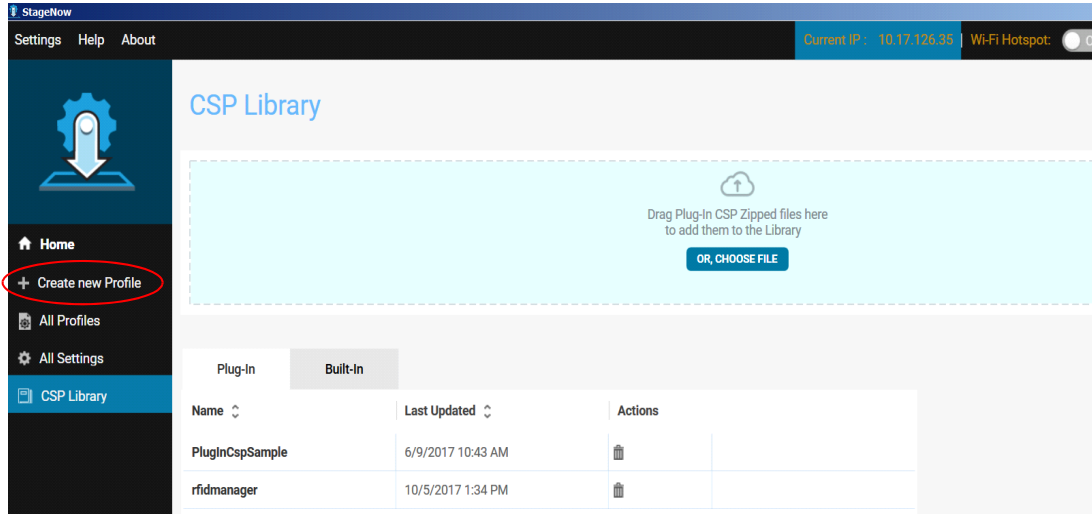

3. From the **Select a Wizard** window, select **XpertMode** then select **Create**.

Figure 52 Wizard Window Selection

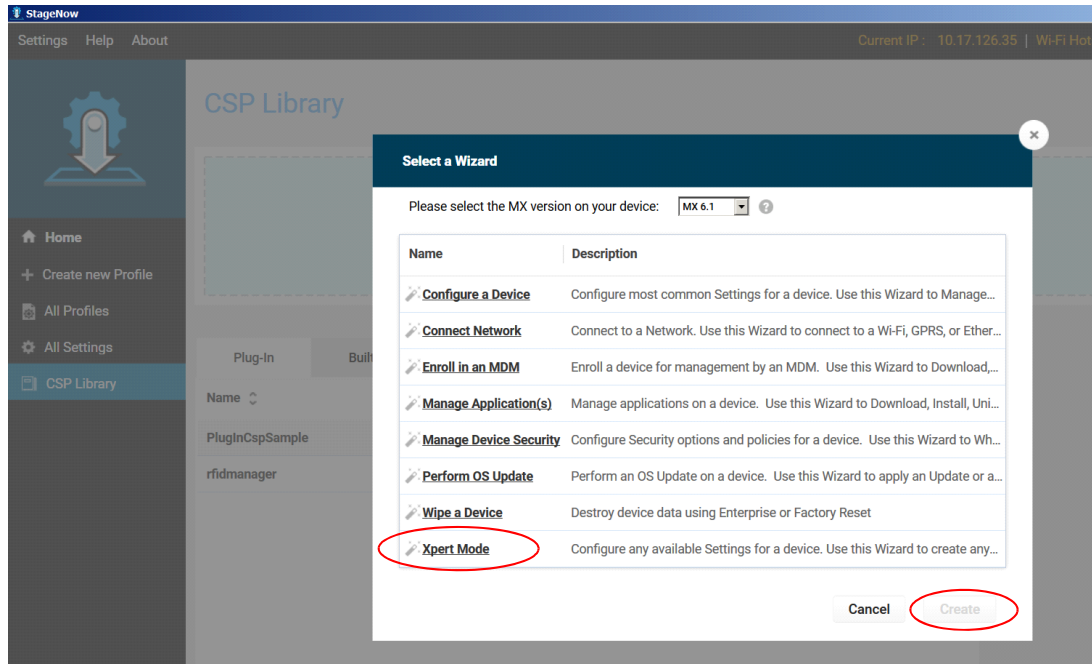

- Enter a new profile name in the **Enter Profile name:** text box. For example, Rfid-N10-Update as shown in [Figure 53](#). Select **Start**.

Figure 53 Create Firmware Update - Profile Name

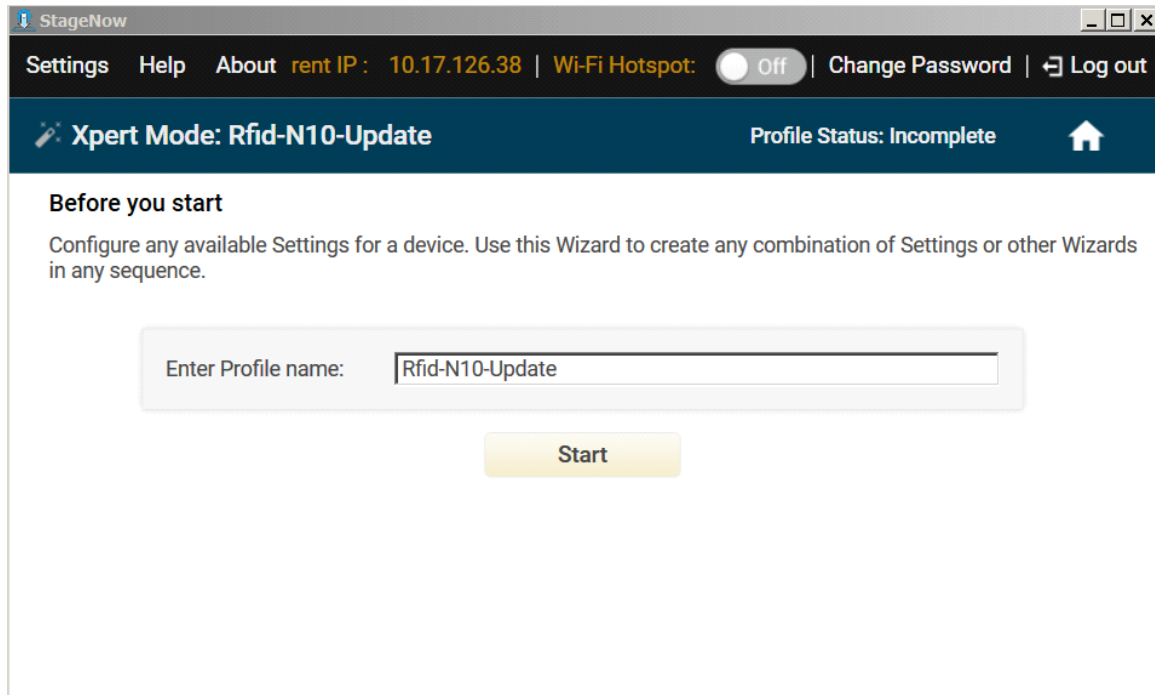

- Select **+** next to **FileMgr CSP** and **rfidmanager CSP** and select **Add**.

Figure 54 Create Firmware Update - Add Applications

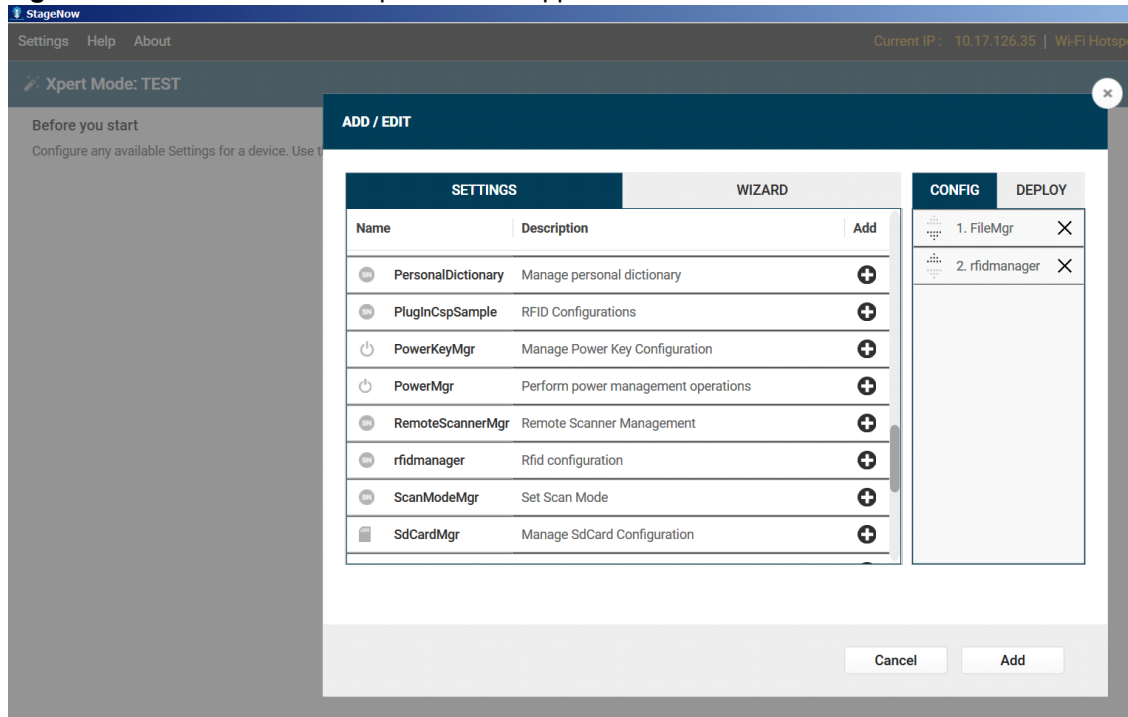

6. Enter the **Target Path and File Name** (i.e., the target path in the device) and the **Source File URI** (i.e., the file path in the staging server) as shown in [Figure 55](#). Select **Continue**.

Figure 55 Create Firmware Update - FileMgr Configuration

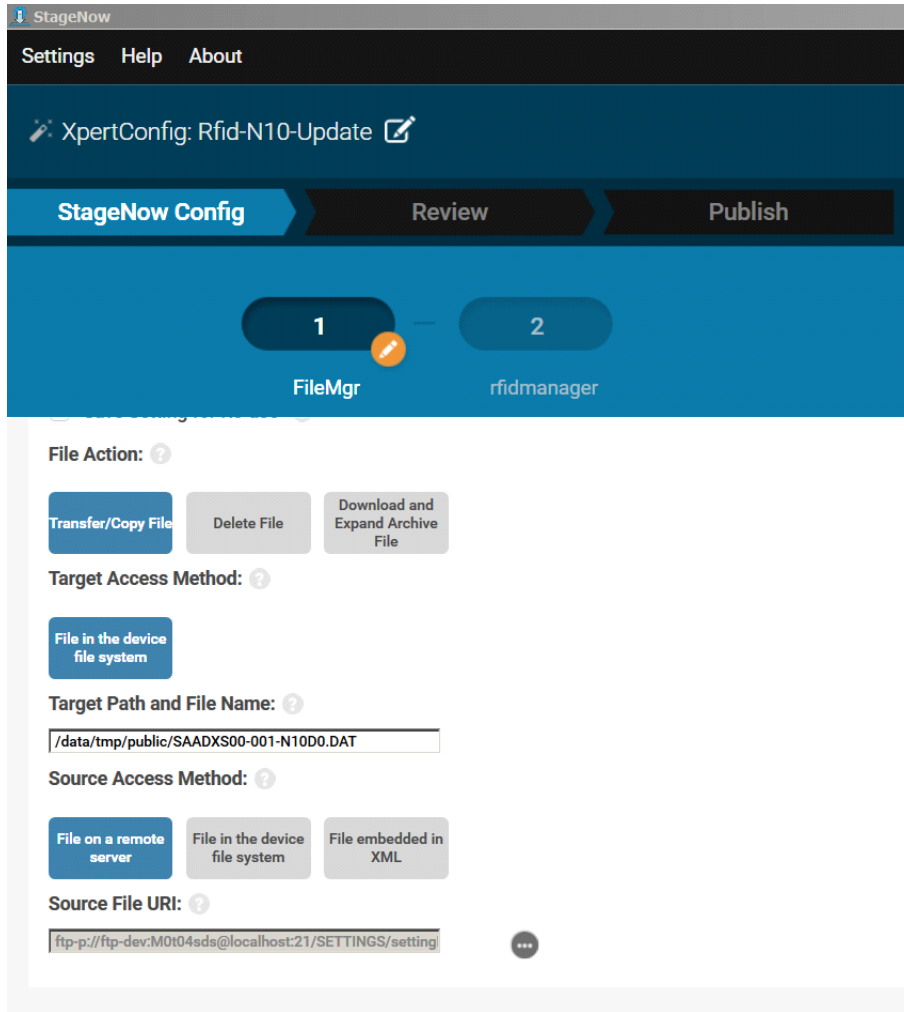

7. Select the **Firmware Update** check box and enter the Firmware **Update FileName**. This is the **Target Path** and **File Name** entered in [Step 6](#) (/data/tmp/public/SAADXS00-001-N10D0.DAT). Select **Continue >**.

Figure 56 Create Firmware Update - RfidManager Configuration

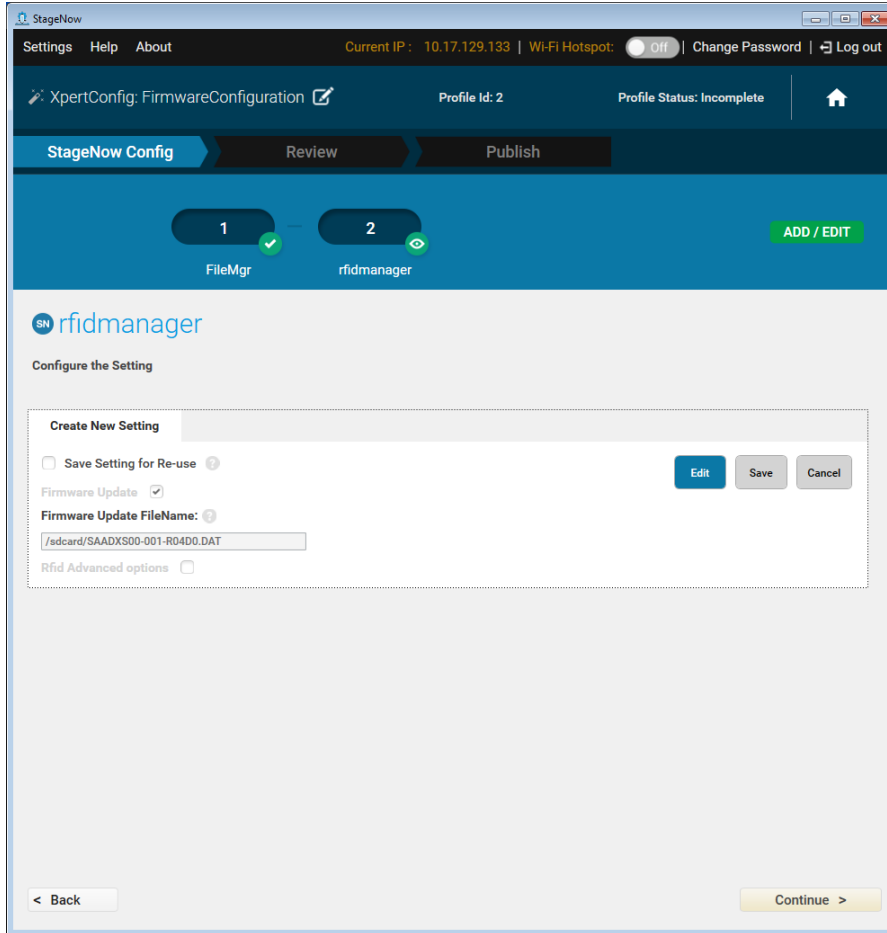

8. Review your input and select **Complete Profile >**.

Figure 57 Review and Complete Profile

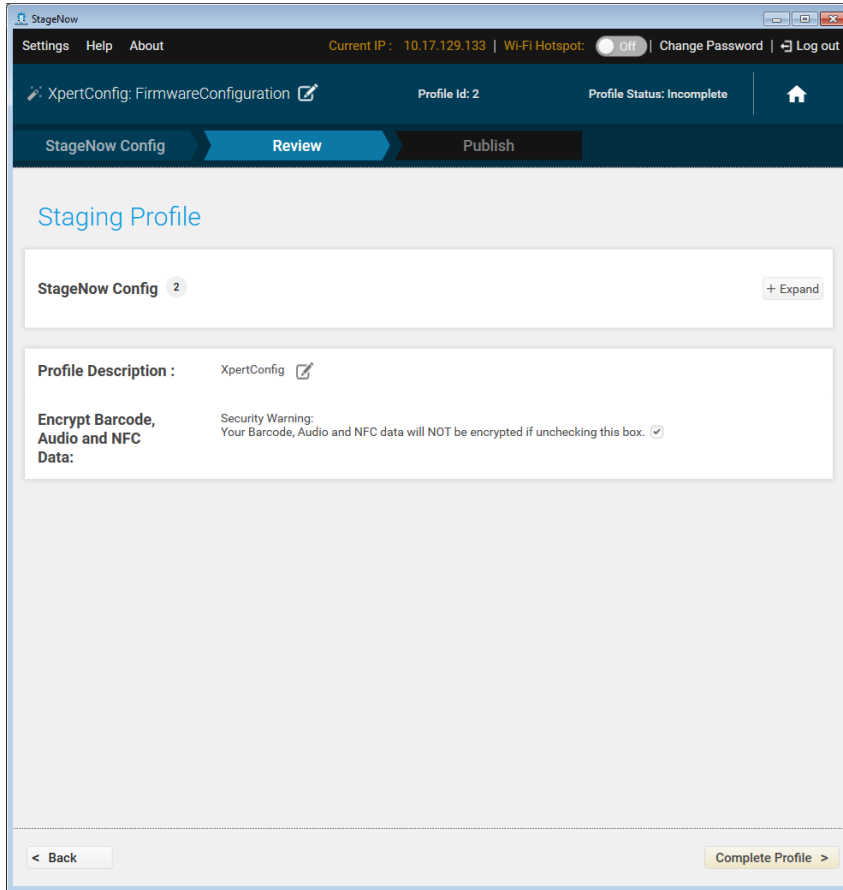

9. Select the required **Barcode Type** check box. Select **Test**.

Figure 58 Create Firmware Update - Barcode Selection

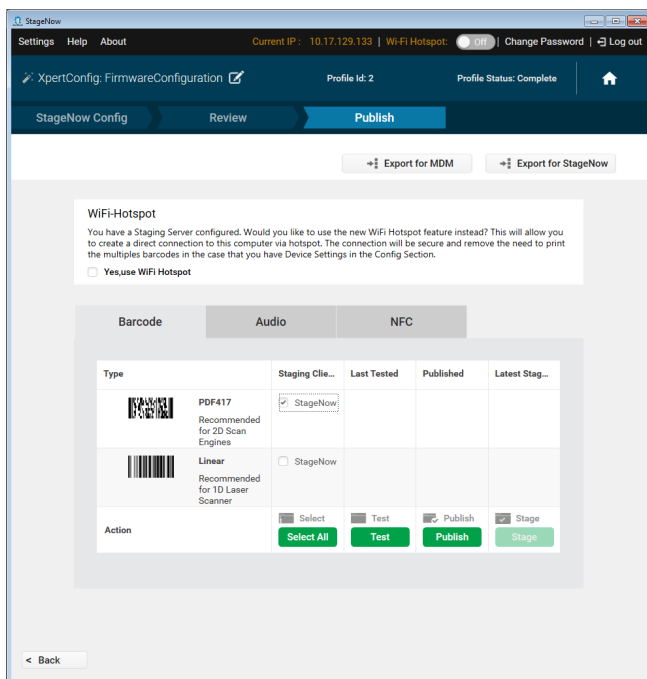

10. Test generates a barcode which can be scanned using the StageNow client on the device to stage the firmware.

Figure 59 Stage Firmware Barcode

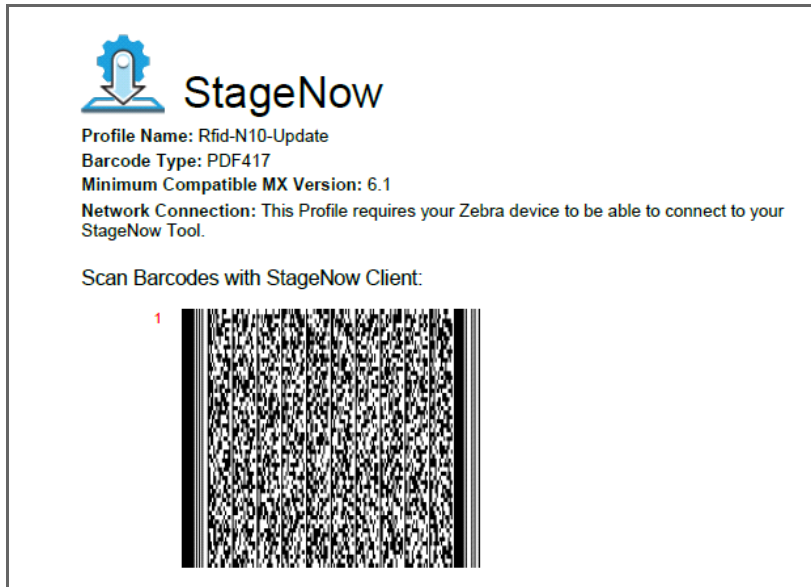

Creating Reader Configurations

This section provides the steps to create a new regulatory configuration profile using advanced options within StageNow.

To create a profile and update the region, channel mask, and channel hopping:

1. Ensure both the device to be staged and the staging server are connected and accessible through the network.
2. Select **Create new Profile** and then select **XpertMode** (see [Figure 51](#) and [Figure 52](#) on [page 63](#)).
3. Select **+** next to **rfidmanager** and select **Add**.

Figure 60 Adding RFID Configuration

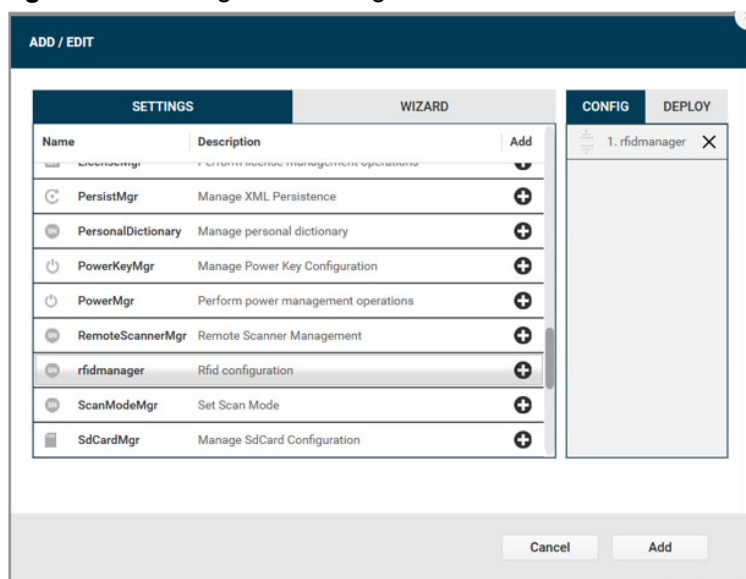

4. Enter the following settings shown in [Figure 61 on page 69](#).
 - Channels Mask
 - Country of Operation (region)
 - Channel Hopping values
 - Antenna information
 - Singulation Control
 - Export Settings

Figure 61 Creating rfidmanager Profile

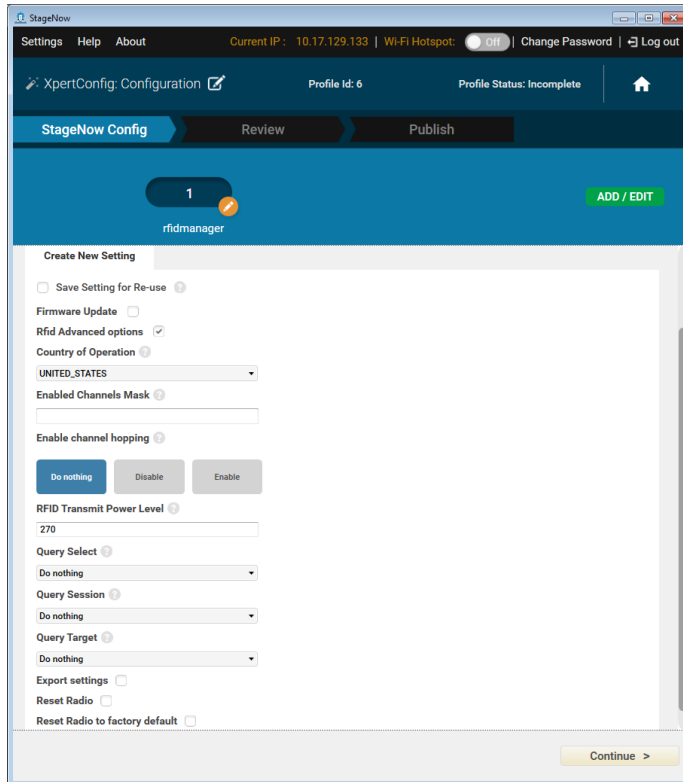

Notes:

- a. Profiles can be created independently for all elements (Channels Mask, Country of Operation, Channel Hopping, Transmit Power Level, Query Session, Export Settings).
 - b. Select **Export settings** for reader information (device details, firmware version, logs, device commands, channel info). All details are stored in the SD card, file name export_logs.txt.
 - c. When channel hopping is enabled, multiple channels can be selected. When channel hopping is disabled, only one channel can be selected to apply the region setting.
 - d. When negative values, strings, or out of bound values are applied those values do not appear in applications.
 - e. When the Country of Operation is the United States, Channels Mask values are not required. If supplied they do not appear in applications.
5. Select **Continue >**, review your inputs, Select **Complete Profile**.
 6. Select the required **Barcode Type** check box. Select **Test**.

Figure 62 Create Regulatory Update - Barcode Selection

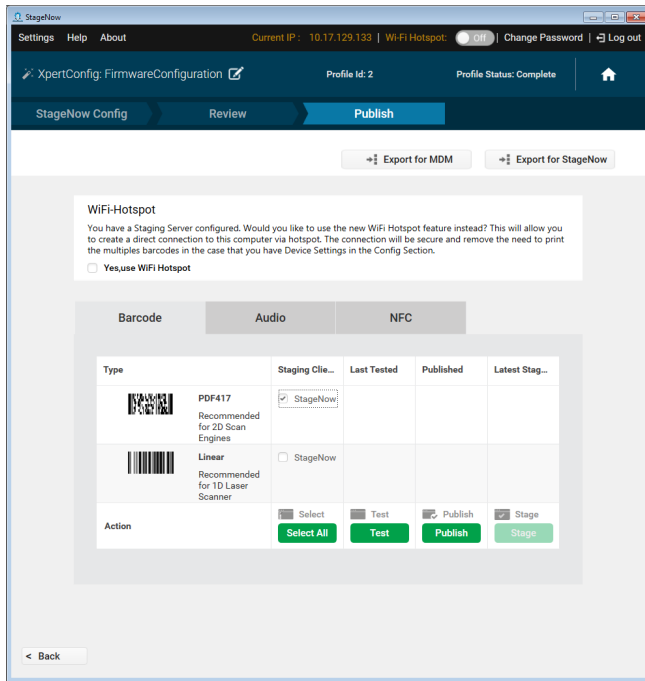

7. Test generates the barcode in [Figure 63](#). This barcode can be scanned using the StageNow client on the device to stage the regulatory advance config and antenna information.

Figure 63 Stage Re regulatory Advance Config and Antenna Barcode

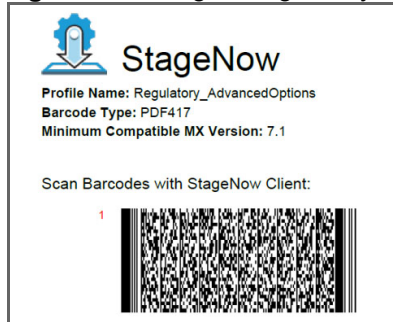

Creating Reset Radio and Reset to Factory Profiles

This section provides the steps to create reset radio and reset to factory profiles using StageNow.

To create reset radio and reset to factory profiles:

1. Ensure both the device to be staged and the staging server are connected and accessible through the network.
2. Select **Create new Profile** and then select **XpertMode** (see [Figure 51](#) and [Figure 52](#) on [page 63](#)).
3. Select  next to rfidmanager and select **Add**.

Figure 64 Adding RFID Configuration



4. Select the **Reset Radio** and Reset Radio to factory default check boxes as shown in Figure 65.

Figure 65 Resetting Radio

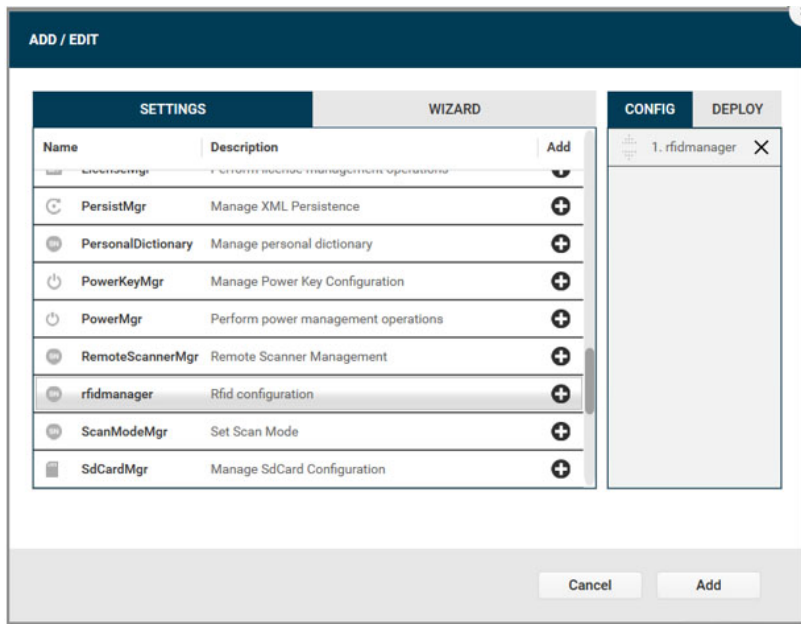
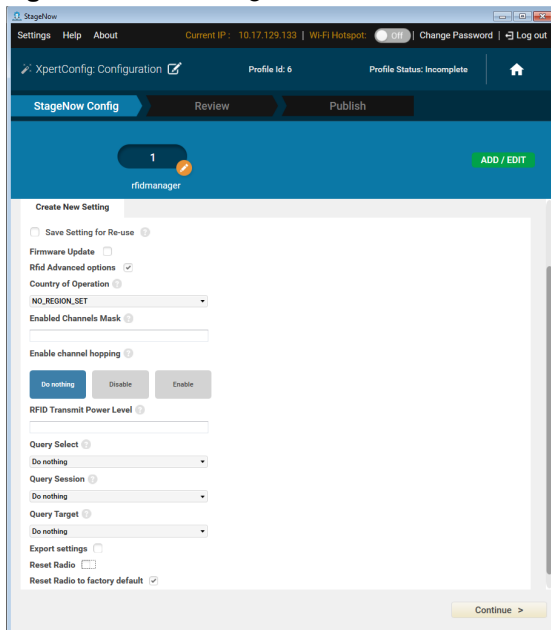

Notes:

- a. Profiles can be created independently for all elements (Reset Radio, Reset Radio to factory default).
 - b. When **Reset Radio** is selected the device battery light blinks and the setting is applied.
 - c. When **Reset Radio to factory default** is selected all the values in both management and demo application reset.
5. Select **Continue >**, review your inputs, Select **Complete Profile**.
 6. Select the required **Barcode Type** check box. Select **Test**.

Figure 66 Create Reset Update - Barcode Selection

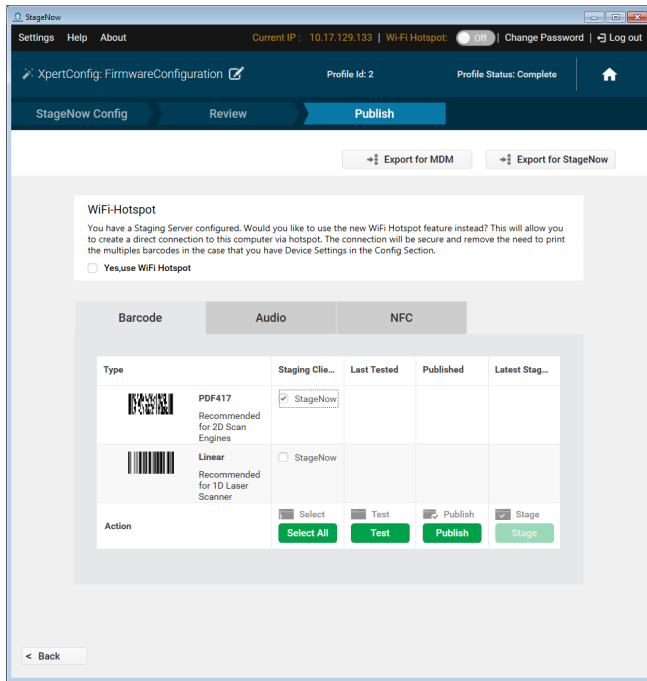

7. Test generates the barcode in Figure 67. This barcode can be scanned using the StageNow client on the device to stage the resets.

Figure 67 Stage Reset



Applying Firmware and Regulatory Updates in One Profile

Both firmware and regulatory updates can be applied using a single profile. Reader firmware is updated first and then the regulatory configuration is applied.

Figure 68 Firmware and Configuration in Single Profile

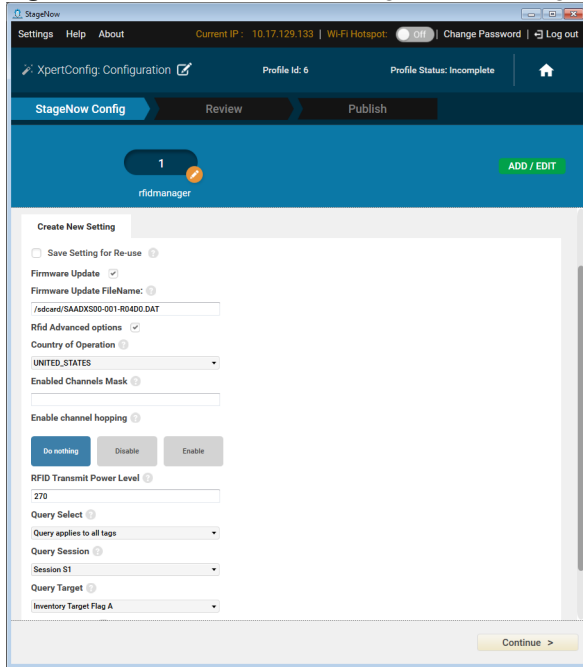

The screenshot shows the StageNow configuration interface for a single profile. The browser address bar shows 'StageNow'. The top navigation bar includes 'Settings', 'Help', and 'About'. The current IP is '10.17.129.133' and the Wi-Fi Hotspot is 'OFF'. There are links for 'Change Password' and 'Log out'. The main content area shows 'XpertConfig: Configuration' with 'Profile Id: 6' and 'Profile Status: Incomplete'. Below this are tabs for 'StageNow Config', 'Review', and 'Publish'. A blue bar contains a '1' in a circle and an 'ADD / EDIT' button. The main form is titled 'Create New Setting' and includes the following fields and options:

- Save Setting for Re-use
- Firmware Update
- Firmware Update FileName:
- Rfid Advanced options
- Country of Operation:
- Enabled Channels Mask:
- Enable channel hopping:
- RFID Transmit Power Level:
- Query Select:
- Query Session:
- Query Target:

A 'Continue >' button is located at the bottom right of the form.

Maintenance and Troubleshooting

Introduction

This chapter includes instructions on cleaning and maintenance, and provides troubleshooting solutions for potential problems.

Cleaning



CAUTION: Always wear eye protection.

Read warning label on compressed air and alcohol product before using.

If you have to use any other solution for medical reasons please contact Zebra for more information.



WARNING: Avoid exposing this product to contact with hot oil or other flammable liquids. If such exposure occurs, unplug the device and clean the product immediately in accordance with these guidelines.

Approved Cleanser Active Ingredients

100% of the active ingredients in any cleaner must consist of one or some combination of the following: isopropyl alcohol, bleach/sodium hypochlorite, hydrogen peroxide or mild dish soap.

Harmful Ingredients

The following chemicals are known to damage the plastics on the RFD2000 and Mobile Computers and can not come in contact with the device: ammonia solutions, compounds of amines or ammonia; acetone; ketones; ethers; aromatic and chlorinated hydrocarbons; aqueous or alcoholic alkaline solutions; ethanolamine; toluene; trichloroethylene; benzene; carbolic acid and TB-lysoform.

Cleaning Instructions

Do not apply liquid directly to the RFD2000 and Mobile Computers. Dampen a soft cloth or use pre-moistened wipes. Do not wrap the device in the cloth or wipe, but gently wipe the unit. Be careful not to let liquid pool around the display window or other places. Allow the unit to air dry before use.



IMPORTANT: Do not clean the device or expose it to rain or moisture when the battery cover is removed. Without the battery cover, the device is not water/dust sealed.

Special Cleaning Notes

Many vinyl gloves contain phthalate additives, which are often not recommended for medical use and are known to be harmful to the housing of the RFD2000 and Mobile Computers. Do not handle the RFD2000 while wearing vinyl gloves containing phthalates, or before hands are washed to remove contaminant residue after gloves are removed. If products containing any of the harmful ingredients listed above are used prior to handling the RFD2000, such as hand sanitizer that contain ethanolamine, hands must be completely dry before handling the RFD2000 to prevent damage to the plastics.

Materials Required

- Alcohol wipes
- Lens tissue
- Cotton tipped applicators
- Isopropyl alcohol
- Can of compressed air with a tube.

Cleaning Cradle Connectors

To clean the connectors on a cradle:

1. Remove the DC power cable from the cradle.
2. Dip the cotton portion of the cotton tipped applicator in isopropyl alcohol.
3. Rub the cotton portion of the cotton tipped applicator along the pins of the connector. Slowly move the applicator back-and-forth from one side of the connector to the other. Do not let any cotton residue on the connector.
4. Rub all sides of the connector with the cotton tipped applicator.
5. Spray compressed air in the connector area by pointing the tube/nozzle about ½ inch away from the surface.



CAUTION: Do not point nozzle at yourself and others, ensure the nozzle or tube is pointed away from your face.

6. Ensure that there is no lint left by the cotton tipped applicator, remove lint if found.
7. If grease and other dirt can be found on other areas of the cradle, use lint free cloth and alcohol to remove.
8. Allow at least 10 to 30 minutes (depending on ambient temperature and humidity) for the alcohol to air dry before applying power to cradle.

If the temperature is low and humidity is high, longer drying time is required. Warm temperature and dry humidity requires less drying time.

Cleaning Frequency

The cleaning frequency is up to the customer's discretion due to the varied environments in which the mobile devices are used. They may be cleaned as frequently as required. However when used in dirty environments it may be advisable to periodically clean the scanner exit window to ensure optimum scanning performance.

Maintenance

For trouble-free service, observe the tips that follow when using the device.

RFD2000

- Although the device is water and dust resistant, do not expose it to rain or moisture for an extended period of time. In general, treat the device as a pocket calculator or other small electronic instrument.
- Do not clean the device or expose it to rain or moisture when the battery is removed. Without the battery, the device is not water/dust sealed.
- Do not drop the device or subject it to strong impact.
- Protect the device from temperature extremes. Do not leave it on the dashboard of a car on a hot day, and keep it away from heat sources.
- Do not store or use the device in any location that is extremely dusty, damp, or wet.
- Do not use window cleaning solution. Use a soft cloth dampened with a 50/50 solution of isopropyl alcohol and water. See [Cleaning on page 74](#).
- Do not allow the solution to form a pool of liquid anywhere on the screen or device.
- Do not use a large amount of solution to cause the device to remain wet.

Battery



WARNING: Do not store the device with the battery installed. Doing so long term may cause irreversible harm to the battery. Always store the battery removed from the device. If a battery is installed during long term storage, it may discharge to point at which it cannot be recovered.

Even when stored separately from device it is important to follow industry standard guidelines. When batteries are stored over a year, battery cell manufacturers advise that some irreversible deterioration in overall battery quality may occur. To minimize this loss, they recommend storing batteries half charged in a dry, cool place between 41° and 77°F (5° and 25°C), the cooler the better. Charge batteries to half capacity at least once a year. In order to charge a battery to half capacity, take a fully discharged battery and charge it for two hours. If an electrolyte leakage is observed, avoid any contact with the affected area and properly dispose of the battery.

Troubleshooting

Troubleshooting RFD2000 RFID Sled with Default LED



NOTE: The troubleshooting information supplied in [Table 9](#) is relevant with the RFD2000 RFID Sled default LED configuration.

Table 9 Troubleshooting the RFD2000 RFID Sled with Default LED

Symptom	Possible Cause	Action
RFID application does not run in the TC20 mobile device.	The RFD2000 RFID Manager APK is not installed.	Install the RFID Manager APK first, before installing the RFID application in the TC20 mobile device. If the TC20 terminal undergoes an enterprise reset, the RFID Manager APK must be re-installed.
RFID Sled does not read tags.	The RF region configuration is not set.	Use the RFID Manager application to set the regulatory region or country operation per the application instructions.

Table 9 Troubleshooting the RFD2000 RFID Sled with Default LED (Continued)

Symptom	Possible Cause	Action
RFID Sled is attached to TC20 mobile device and it is not responsive to a RFID application, even after the trigger is pressed.	Battery is too low and not able to power the RFID Sled.	Press the trigger for a couple of seconds to power the RFID Sled On. The RFID Sled LED blinks amber when it is turned On. (By default, pressing the trigger turns On the RFID Sled if it is in Off mode. However, the RFID Sled can be disabled in which case this step is not necessary.) Place the RFID Sled in the charging cradle. The RFID Sled blinks amber LEDs indicating charging commenced. See LED Indications on page 13 .
	Zebra TC20 mobile computer is not properly inserted in the RFID Sled.	Remove and reinsert the Zebra mobile device securely in the RFID Sled. See Attaching Mobile Computer to RFID Sled on page 16 .
	Damaged battery.	If the RFD2000 RFID Sled LED does not blink amber after sitting on charging cradle for a while, request service to replace battery. See Service Information on page 9 .
RFID Sled not responsive to application and RFD2000 RFID Sled red LED is On or blinks.	Recovery mode is enabled.	If recovery mode is entered unintentionally, wait for approximately 1.5 minutes for the RFID Sled to exit recovery mode on its own. See Recovery Mode on page 13 .
RFID Sled is responsive but cannot read tags.	Battery is critically low.	Place the RFID Sled in the charging cradle. The RFID Sled LED blinks amber. The RFID Sled can be used when its LED turns on momentarily amber or green upon removal from charging cradle.
The RFD2000 RFID Sled LED blinks fast amber when in the cradle.	Charging error.	Restart charging by removing the RFID Sled from the cradle and inserting it back in the cradle. If issue persists, request service to replace battery. See Service Information on page 9 .
RFID Sled red LED momentarily turns On when the RFID Sled is removed from cradle.	This is an indication that the RFID Sled is removed too early from cradle because the battery level is still low.	Place the RFID Sled back in charger until the battery is sufficiently charged.
RFID Sled LED blinks red, or LED blinks red alternating with green or amber while in use (not while charging).	Battery end of life indication.	Request service to replace battery. See Service Information on page 9 .
Zebra TC20 Mobile Computer battery is not charging.	Charging cradle was unplugged from AC power.	Ensure the charging cradle is receiving power.
	Zebra TC20 Mobile Computer is not fully seated in the cradle.	Remove and re-insert the Zebra TC20 Mobile Computer into the cradle, ensuring it is firmly seated in the charging cradle.

Troubleshooting RFD2000 RFID Sled with LED Mode 2



NOTE: In addition to the troubleshooting information supplied in [Table 9](#), [Table 10](#) is relevant when the RFD2000 RFID Sled is configured to indicate battery charge status when pressing the trigger. This is LED Mode 2 as described in [Table 5 on page 12](#).

Table 10 Troubleshooting RFD2000 RFID Sled with LED Mode 2

Symptom	Possible Cause	Action
The RFID Sled LED does not blink when the trigger is pressed.	Battery is too low and not able to power the RFID Sled.	Press the trigger for a couple of seconds to power the RFID Sled On. The RFID Sled LED blinks amber when it is turned On. (By default, pressing the trigger turns the RFID Sled On if it is in Off mode. However, the RFID Sled can be disabled, in which case this step is not necessary.) Place the RFID Sled in the charging cradle. The RFID Sled blinks amber LEDs indicating charging commenced. See LED Indications on page 13
	Damaged battery.	If the RFD2000 RFID Sled LED does not blink amber after sitting on charging cradle for a while, request service to replace battery. See Service Information on page 9 .
RFID Sled is attached to TC20 mobile device and it is not responsive to a RFID application, even after the trigger is pressed.	Battery is too low and not able to power the RFID Sled.	Press the trigger for a couple of seconds to power the RFID Sled On. The RFID Sled LED blinks amber when it is turned On. (By default, pressing the trigger turns On the RFID Sled if it is in Off mode. However, the RFID Sled can be disabled in which case this step is not necessary.) Place the RFID Sled in the charging cradle. The RFID Sled blinks amber LEDs indicating charging commenced. See LED Indications on page 13 .
	Damaged battery.	If the RFD2000 RFID Sled LED does not blink amber after sitting on charging cradle for a while, request service to replace battery. See Service Information on page 9 .
	Zebra TC20 mobile computer is not properly inserted in the RFID Sled.	Remove and reinsert the Zebra mobile device securely in the RFID Sled. See Attaching Mobile Computer to RFID Sled on page 16 .
	TC20 Mobile computer cannot connect with RFID Sled.	If a RFID Sled trigger press turns the RFID Sled LED green or amber, the Sled is functional. Try a different TC20 Mobile Computer with the same RFID Sled, or reboot the TC20 Mobile Computer and retry to connect to the RFID Sled.
RFID Sled is responsive but cannot read tags.	Battery is critically low.	If pressing the RFID Sled trigger turns on the red LED, place the RFID Sled in the charging cradle. The RFID Sled LED blinks amber. The RFID Sled can be used when its LED turns on momentarily amber or green upon removal from charging cradle.

Data Dictionary

Introduction

This chapter includes attributes numbers (configuration parameters, monitored data, and born on information about the device) and the management of the various attribute domains. This information applies to both barcode scanners and OEM engines.

RFD2000 Attributes

Attribute Definitions

- Attribute Number - Contains the attribute number. All attributes numbers are unique.
- Attribute Name - Defines the name of the attribute.
- Descriptions - Contains a description of the attribute.
- Type - Defined in [Table 11](#).

Table 11 Attribute Types

Type	Definition
B	Byte - unsigned char
C	Char - single byte
F	Bit flags
W	WORD - Short unsigned integer (16 bits)
I	SWORD - Short signed integer (16 bits)
D	DWORD - Long unsigned integer (32 bits)
L	SDWORD - Long signed integer (32 bits)
A	Array
S	String
X	Action
N	Indication of last parameter

- Size - Provides the size of the attribute.
- Values - The valid range of values reported/accepted.
- User Mode Access - Defines if the attribute is read only or read/write.

Inventory Command Configurations

Table 12 Inventory Command Configurations

Attribute Number	Attribute Name	Description	Type	Size (Byte)	Values	Default Value	User Mode Access
BYTE PARAMS							
1501	ATT_RFID_TAG_REPORT_FIRST_SEEN_TIME	Enable or Disable first seen timestamp field for inventoried tags reported over ZETI interface	'B'	1	0 -1(0:Disable 1:Enable)	1	RW
1502	ATT_RFID_TAG_REPORT_LAST_SEEN_TIME	Enable or Disable last seen timestamp field for inventoried tags reported over ZETI interface	'B'	1	0 -1(0:Disable 1:Enable)	0	RW
1503	ATT_RFID_TAG_REPORT_PROTOCOL_CONTROL	Enable or Disable Protocol Control field for inventoried tags reported over ZETI interface	'B'	1	0 -1(0:Disable 1:Enable)	0	RW
1504	ATT_RFID_TAG_REPORT_RSSI	Enable or Disable RSSI field for inventoried tags reported over ZETI interface	'B'	1	0 -1(0:Disable 1:Enable)	1	RW
1505	ATT_RFID_TAG_REPORT_PHASE	Enable or Disable phase difference field for inventoried tags reported over ZETI interface	'B'	1	0 -1(0:Disable 1:Enable)	0	RW
1506	ATT_RFID_TAG_REPORT_CHANNEL_INDEX	Enable or Disable channel index field for inventoried tags reported over ZETI interface	'B'	1	0 -1(0:Disable 1:Enable)	0	RW
1507	ATT_RFID_TAG_REPORT_TAG_SEEN_COUNT	Enable or Disable tag seen count field for inventoried tags reported over ZETI interface	'B'	1	0 -1(0:Disable 1:Enable)	1	RW

Data Dictionary

Attribute Number	Attribute Name	Description	Type	Size (Byte)	Values	Default Value	User Mode Access
1509 (US Only)	ATT_RFID_ANT_IP_INDEX	Index of radio link profile to be used	'B'	1	0 - 35(0: DivideRatio: 8, BDR: 60000, M: M4, FLM: PR_ASK, PIE: 1500, MinTari: 25000, MaxTari: 25000, StepTari: 0, 1: DivideRatio: 8, BDR: 640000, M: FM0, FLM: PR_ASK, PIE: 1500, MinTari: 6250, MaxTari: 6250, StepTari: 0, 2: DivideRatio: 8, BDR: 640000, M: FM0, FLM: PR_ASK, PIE: 2000, MinTari: 6250, MaxTari: 6250, StepTari: 0, 3: DivideRatio: 8, BDR: 120000, M: M2, FLM: PR_ASK, PIE: 1500, MinTari: 25000, MaxTari: 25000, StepTari: 0, 4: DivideRatio: 8, BDR: 120000, M: M2, FLM: PR_ASK, PIE: 1500, MinTari: 12500, MaxTari: 23000, StepTari: 2100, 5: DivideRatio: 8, BDR: 120000, M: M2, FLM: PR_ASK, PIE: 2000, MinTari: 25000, MaxTari: 25000, StepTari: 0, 6: DivideRatio: 8, BDR: 120000, M: M2, FLM: PR_ASK, PIE: 2000, MinTari: 12500, MaxTari: 23000, StepTari: 2100, 7: DivideRatio: 8, BDR: 128000, M: M2, FLM: PR_ASK, PIE: 1500, MinTari: 25000, MaxTari: 25000, StepTari: 0, 8: DivideRatio: 8, BDR: 128000, M: M2, FLM: PR_ASK, PIE: 1500, MinTari: 12500, MaxTari: 23000, StepTari: 2100, 9: DivideRatio: 8, BDR: 128000, M: M2, FLM: PR_ASK, PIE: 2000, MinTari: 25000, MaxTari: 25000, StepTari: 0, 10: DivideRatio: 8, BDR: 128000, M: M2, FLM: PR_ASK, PIE: 2000, MinTari: 12500, MaxTari: 23000, StepTari: 2100, 11: DivideRatio: 8, BDR: 160000, M: M2, FLM: PR_ASK, PIE: 1500, MinTari: 12500, MaxTari: 18800, StepTari: 2100, 12: DivideRatio: 8, BDR: 160000, M: M2, FLM: PR_ASK, PIE: 2000, MinTari: 12500, MaxTari: 18800, StepTari: 2100, 13: DivideRatio: 8, BDR: 60000, M: M4, FLM: PR_ASK, PIE: 1500, MinTari: 25000, MaxTari: 25000, StepTari: 0, 14: DivideRatio: 8, BDR: 60000, M: M4, FLM: PR_ASK, PIE: 1500, MinTari: 12500, MaxTari: 23000, StepTari: 2100, 15: DivideRatio: 8, BDR: 60000, M: M4, FLM: PR_ASK, PIE: 2000, MinTari: 25000, MaxTari: 25000, StepTari: 0, 16: DivideRatio: 8, BDR: 60000, M: M4, FLM: PR_ASK, PIE: 2000, MinTari: 12500, MaxTari: 23000, StepTari: 2100,	0	RW

Data Dictionary

Attribute Number	Attribute Name	Description	Type	Size (Byte)	Values	Default Value	User Mode Access
1509 (continued)	ATT_RFID_ANT_IP_INDEX	Index of radio link profile to be used	'B'	1	<p>17: DivideRatio: 8, BDR: 64000, M: M4, FLM: PR_ASK, PIE: 1500, MinTari: 25000, MaxTari: 25000, StepTari: 0,</p> <p>18: DivideRatio: 8, BDR: 64000, M: M4, FLM: PR_ASK, PIE: 1500, MinTari: 12500, MaxTari: 23000, StepTari: 2100,</p> <p>19: DivideRatio: 8, BDR: 64000, M: M4, FLM: PR_ASK, PIE: 2000, MinTari: 25000, MaxTari: 25000, StepTari: 0,</p> <p>20: DivideRatio: 8, BDR: 64000, M: M4, FLM: PR_ASK, PIE: 2000, MinTari: 12500, MaxTari: 23000, StepTari: 2100,</p> <p>21: DivideRatio: 8, BDR: 80000, M: M4, FLM: PR_ASK, PIE: 1500, MinTari: 12500, MaxTari: 18800, StepTari: 2100,</p> <p>22: DivideRatio: 8, BDR: 80000, M: M4, FLM: PR_ASK, PIE: 2000, MinTari: 12500, MaxTari: 18800, StepTari: 2100,</p> <p>23: Automatic Profile,</p> <p>24: DivideRatio: 8, BDR: 320000, M: FM0, FLM: PR_ASK, PIE: 1500, MinTari: 12500, MaxTari: 18800, StepTari: 2100</p> <p>25: DivideRatio: 8, BDR: 320000, M: FM0, FLM: PR_ASK, PIE: 2000, MinTari: 12500, MaxTari: 18800, StepTari: 2100,</p> <p>26: DivideRatio: 8, BDR: 30000, M: M8, FLM: PR_ASK, PIE: 1500, MinTari: 25000, MaxTari: 25000, StepTari: 0,</p> <p>27: DivideRatio: 8, BDR: 30000, M: M8, FLM: PR_ASK, PIE: 1500, MinTari: 12500, MaxTari: 23000, StepTari: 2100,</p> <p>28: DivideRatio: 8, BDR: 30000, M: M8, FLM: PR_ASK, PIE: 2000, MinTari: 25000, MaxTari: 25000, StepTari: 0,</p> <p>29: DivideRatio: 8, BDR: 30000, M: M8, FLM: PR_ASK, PIE: 2000, MinTari: 12500, MaxTari: 23000, StepTari: 2100,</p> <p>30: DivideRatio: 8, BDR: 32000, M: M8, FLM: PR_ASK, PIE: 1500, MinTari: 25000, MaxTari: 25000, StepTari: 0,</p> <p>31: DivideRatio: 8, BDR: 32000, M: M8, FLM: PR_ASK, PIE: 1500, MinTari: 12500, MaxTari: 23000, StepTari: 2100,</p> <p>32: DivideRatio: 8, BDR: 32000, M: M8, FLM: PR_ASK, PIE: 2000, MinTari: 25000, MaxTari: 25000, StepTari: 0,</p> <p>33: DivideRatio: 8, BDR: 32000, M: M8, FLM: PR_ASK, PIE: 2000, MinTari: 12500, MaxTari: 23000, StepTari: 2100,</p>	0	RW

Data Dictionary

Attribute Number	Attribute Name	Description	Type	Size (Byte)	Values	Default Value	User Mode Access
1509 (continued)	ATT_RFID_ANT_IP_INDEX	Index of radio link profile to be used	'B'	1	34: DivideRatio: 8, BDR: 40000, M: M8, FLM: PR_ASK, PIE: 1500, MinTari: 12500, MaxTari: 18800, StepTari: 2100, 35: DivideRatio: 8, BDR: 40000, M: M8, FLM: PR_ASK, PIE: 2000, MinTari: 12500, MaxTari: 18800, StepTari: 2100,)	0	RW
1510	ATT_RFID_ANT_SELECT	Enable or Disable Air Interface level tag selection (pre-filter)	'B'	1	0 -1(0:Disable 1:Enable)	0	RW
WORD PARAMS							
1623	ATT_RFID_ANTENNA_POWER	Power level for RF transmission in 10s of dBm	'W'	2	0 - 300	270dBm	RW
DWORD PARAMS							
1643	ATT_RFID_ANTENNA_TARI	Tari value, in nano-seconds	'D'	4	0 - 4294967295(One of the following values: 6250 12500 14600 16700 18800 20900 23000 25000)	0	RW

Tag Select Configurations

Table 13 Tag Select Configurations

Attribute Number	Attribute Name	Description	Type	Size (Byte)	Values	Default Value	User Mode Access
BYTE PARAMS							
1511	ATT_RFID_TAG_SELECT_1_ENABLE	Enable or disable select filter 1	'B'	1	0 - 1(0:Disable 1:Enable)	0	RW
1512	ATT_RFID_TAG_SELECT_1_TARGET	Target for select filter 1	'B'	1	0 - 4(0: Session S0 1: Session S1 2: Session S2 3: Session S3 4: Select Flag)	2	RW
1513	ATT_RFID_TAG_SELECT_1_ACTION	Action for select filter 1	'B'	1	0 - 7 (See section action value, Table 16)	0	RW
1514	ATT_RFID_TAG_SELECT_1_MEMBANK	Memory bank for select filter 1	'B'	1	0- 3(0:Reserved 1:EPC 2:TID 3:USER)	1	RW
1515	ATT_RFID_TAG_SELECT_1_TRUNCATE	Enable or disable truncated reply for select filter 1	'B'	1	0 -1(0:Disable 1:Enable)	0	RW

Data Dictionary

Attribute Number	Attribute Name	Description	Type	Size (Byte)	Values	Default Value	User Mode Access
1516	ATT_RFID_TAG_SELECT_1_LENGTH	Number of bits from start of match pattern to be used for select mask for select filter 1	'B'	1	0 - 255	16	RW
1517	ATT_RFID_TAG_SELECT_2_ENABLE	Enable or disable select filter 2	'B'	1	0 -1(0:Disable 1:Enable)	0	RW
1518	ATT_RFID_TAG_SELECT_2_TARGET	Target for select filter 2	'B'	1	0 - 4(0: Session S0 1: Session S1 2: Session S2 3: Session S3 4: Select Flag)	2	RW
1519	ATT_RFID_TAG_SELECT_2_ACTION	Action for select filter 2	'B'	1	0 - 7 (See section Action Value, Table 16)	0	RW
1536	ATT_RFID_TAG_SELECT_2_MEMBANK	Memory bank for select filter 2	'B'	1	0- 3(0:Reserved 1:EPC 2:TID 3:USER)	1	RW
1537	ATT_RFID_TAG_SELECT_2_TRUNCATE	Enable or disable truncated reply for select filter 2	'B'	1	0 -1(0:Disable 1:Enable)	0	RW
1538	ATT_RFID_TAG_SELECT_2_LENGTH	Number of bits from start of match pattern to be used for select mask for select filter 2	'B'	1	0 - 255	16	RW
1539	ATT_RFID_TAG_SELECT_3_ENABLE	Enable or disable select filter 3	'B'	1	0 -1(0:Disable 1:Enable)	0	RW
1540	ATT_RFID_TAG_SELECT_3_TARGET	Target for select filter 3	'B'	1	0 - 4(0: Session S0 1: Session S1 2: Session S2 3: Session S3 4: Select Flag)	2	RW
1541	ATT_RFID_TAG_SELECT_3_ACTION	Action for select filter 3	'B'	1	0 - 7 (See section Action Value, Table 16)	0	RW
1542	ATT_RFID_TAG_SELECT_3_MEMBANK	Memory bank for select filter 3	'B'	1	0- 3(0:Reserved 1:EPC 2:TID 3:USER)	1	RW
1543	ATT_RFID_TAG_SELECT_3_TRUNCATE	Enable or disable truncated reply for select filter 3	'B'	1	0 -1(0:Disable 1:Enable)	0	RW

Data Dictionary

Attribute Number	Attribute Name	Description	Type	Size (Byte)	Values	Default Value	User Mode Access
1544	ATT_RFID_TAG_SELECT_3_LENGTH	Number of bits from start of match pattern to be used for select mask for select filter 3	'B'	1	0 - 255	16	RW
1545	ATT_RFID_TAG_SELECT_4_ENABLE	Enable or disable select filter 4	'B'	1	0 -1(0:Disable 1:Enable)	0	RW
1546	ATT_RFID_TAG_SELECT_4_TARGET	Target for select filter 4	'B'	1	0 - 4(0: Session S0 1: Session S1 2: Session S2 3: Session S3 4: Select Flag)	2	RW
1547	ATT_RFID_TAG_SELECT_4_ACTION	Action for select filter 4	'B'	1	0 - 7 (See section Action Value, Table 16)	0	RW
1548	ATT_RFID_TAG_SELECT_4_MEMBANK	Memory bank for select filter 4	'B'	1	0- 3(0:Reserved 1:EPC 2:TID 3:USER)	0	RW
1549	ATT_RFID_TAG_SELECT_4_TRUNCATE	Enable or disable truncated reply for select filter 4	'B'	1	0 -1(0:Disable 1:Enable)	0	RW
1550	ATT_RFID_TAG_SELECT_4_LENGTH	Number of bits from start of match pattern to be used for select mask for select filter 4	'B'	1	0 - 255	16	RW
WORD PARAMS							
1624	ATT_RFID_TAG_SELECT_1_POINTER	Start position in bits from beginning of memory bank from where match needs to be performed.	'W'	2	0 - 512	16	RW
1625	ATT_RFID_TAG_SELECT_2_POINTER	Start position in bits from beginning of memory bank from where match needs to be performed.	'W'	2	0 - 512	16	RW
1626	ATT_RFID_TAG_SELECT_3_POINTER	Start position in bits from beginning of memory bank from where match needs to be performed.	'W'	2	0 - 512	16	RW
1627	ATT_RFID_TAG_SELECT_4_POINTER	Start position in bits from beginning of memory bank from where match needs to be performed.	'W'	2	0 - 512	16	RW

Data Dictionary

Attribute Number	Attribute Name	Description	Type	Size (Byte)	Values	Default Value	User Mode Access
STRING PARAMS							
1650	ATT_RFID_TAG_SEL_1_MASK	Mask for select filter 1	'S'	34	Variable (Sequence of bytes. Maximum 34 bytes)	NULL STRING (0x00,0x00)	RW
1651	ATT_RFID_TAG_SEL_2_MASK	Mask for select filter 2	'S'	34	Variable (Sequence of bytes. Maximum 34 bytes)	NULL STRING(0x00,0x00)	RW
1652	ATT_RFID_TAG_SEL_3_MASK	Mask for select filter 3	'S'	34	Variable (Sequence of bytes. Maximum 34 bytes)	NULL STRING (0x00,0x00)	RW
1653	ATT_RFID_TAG_SEL_4_MASK	Mask for select filter 4	'S'	34	Variable (Sequence of bytes. Maximum 34 bytes)	NULL STRING(0x00,0x00)	RW

Tag Query Configurations

Table 14 Tag Query Configurations

Attribute Number	Attribute Name	Description	Type	Size (Byte)	Values	Default Value	User Mode Access
BYTE PARAMS							
1551	ATT_RFID_TAG_QUERY_SELECT	State of tag's SL flag to filter tags for which query is applicable	'B'	1	0 - 3(0: Query applies to all tags 1: 2: Query applies to tag with SL De-Asserted 3: Query applies to tag with SL Asserted)	0	RW
1552	ATT_RFID_TAG_QUERY_SESSION	Session on which query is applicable	'B'	1	10 - 3(0: Session S0 1: Session S1 2: Session S2 3: Session S3)	1	RW
1553	ATT_RFID_TAG_QUERY_TARGET	Tag's target inventory flag state. If target is set to AB flip, after an inventory round with target A, inventory round is repeated with target B.	'B'	1	0 - 2(0: Inventory target flag A 1: Inventory target flag B 2: AB flip)	0	RW
DWORD PARAMS							
1644	ATT_RFID_TAG_POPULATION	Default expected tag population in the field while reader is operated	'D'	4	0 - 4294967295	30	RW

Tag Access Configurations

Table 15 Tag Access Configurations

Attribute Number	Attribute Name	Description	Type	Size (Byte)	Values	Default Value	User Mode Access
BYTE PARAMS							
1554	ATT_RFID_TAG_ACCESS_CRITERIA_IDX	Index to list of access criteria to choose criteria to be used during access operation	'B'	1	0 -1(0:Disable 1:Enable)	0	RW
1555	ATT_RFID_TAG_ACCESS_CMD	Default access command identifier	'B'	1	0 -255(7: Read 8: Write 9: Lock 10: Kill 11: Block Erase 12: Block Perma Lock)	7	RW
1556	ATT_RFID_TAG_READ_MEMBANK	Memory bank to read. Applicable for Read access operation.	'B'	1	0- 3(0:Reserved 1:EPC 2:TID 3:USER)	3	RW
1557	ATT_RFID_TAG_READ_LENGTH	Number of words to read. 0 means all data in bank.	'B'	1	0-64	0	RW
1558	ATT_RFID_TAG_WRITE_MEMBANK	Memory bank to write. Applicable for write access operation.	'B'	1	0- 3(0:Reserved 1:EPC 2:TID 3:USER)	3	RW
1559	ATT_RFID_TAG_WRITE_DOBLOCK_WRITE	Perform Block Write operation when Write access operation is performed.	'B'	1	0 -1(0: Do not perform Block Write for Write operation 1: Perform Block Write for Write Operation)	0	RW
1560	ATT_RFID_TAG_BLOCK_ERASE_MEMBANK	Memory bank for Block Erase. Applicable for Block Erase access operation	'B'	1	0- 3(0:Reserved 1:EPC 2:TID 3:USER)	3	RW
1561	ATT_RFID_TAG_BLOCK_ERASE_LENGTH	Number of words to erase	'B'	1	1-128	1	RW
1562	ATT_RFID_TAG_BLOCK_PERMA_DLOCK	Perform Block Perma Lock or Read current Perma Lock status	'B'	1	0 -1(0: Read Block Perma Lock Status 1: Perform Block Perma Lock)	0	RW

Data Dictionary

Attribute Number	Attribute Name	Description	Type	Size (Byte)	Values	Default Value	User Mode Access
1563	ATT_RFID_TAG_BLOCK_PERMA_MEMORY_BANK	Memory Bank on which Block Perma Lock operation needs to be performed	'B'	1	0- 3(0:Reserved 1:EPC 2:TID 3:USER)	3	RW
1565	ATT_RFID_TAG_BLOCK_PERMA_LOCK_BLOCK_RANGE	Block Perma Lock Mask Range in units of 16 blocks	'B'	1	0 - 255	1	RW
WORD PARAMS							
1564	ATT_RFID_TAG_BLOCK_PERMA_LOCK_BLOCK_PTR	Starting address of block mask in units of 16 blocks	'W'	2	0 - 65535	0	RW
1628	ATT_RFID_TAG_READ_OFFSET	Number of words offset from beginning of data bank, from where the read operation needs to be performed.	'W'	2	0 - 65535	0	RW
1629	ATT_RFID_TAG_WRITE_OFFSET	Number of words offset from beginning of data bank, from where the write operation needs to be performed.	'W'	2	0 - 65535	0	RW
1630	ATT_RFID_TAG_BLOCK_ERASE_OFFSET	Number of words offset from beginning of data bank, from where the block erase operation needs to be performed.	'W'	2	0 - 65535	0	RW
STRING PARAMS							
1654	ATT_RFID_TAG_WRITE_DATA_BUFFER	Data to be written for tag write access operation	'S'	34	Variable (Sequence of bytes. Maximum 34 bytes)	NULL STRING (0x00,0x00)	RW
1684	ATT_RFID_TAG_BLOCK_PERMA_LOCK_BLOCK_MASK		'S'	32	Variable (Sequence of bytes. Maximum 32 bytes)	NULL STRING (0x00,0x00)	RW
1655	ATT_RFID_TAG_BLOCK_LOCK_MASK	Mask value for tag lock operation	'S'	5	Variable (Sequence of bytes. Maximum 5 bytes)	0x07,0x07,0x07,0x07,0x07	RW

Data Dictionary

Attribute Number	Attribute Name	Description	Type	Size (Byte)	Values	Default Value	User Mode Access
DWORD PARAMS							
1645	ATT_RFID_TAG_ACCESS_PWD	Password for access operations	'D'		0 - 4294967295	0	RW

Region Configurations

Table 16 Region Configurations

Attribute Number	Attribute Name	Description	Type	Size (Byte)	Values	Default Value	User Mode Access
BYTE PARAMS							
1581	ATT_RFID_REGION_SKU	RFID regulatory identifier	'B'	1	0 - 255	1	RW
1582	ATT_RFID_REGION_DEV_NAME		'B'	1	0 - 255		RW

Data Dictionary

Attribute Number	Attribute Name	Description	Type	Size (Byte)	Values	Default Value	User Mode Access
1583	ATT_RFID_REGION_CODE	Country of operation for unit. Regulatory setting will be dependent on this selection.	'B'	1	0 -255{ 0: NO_REGION_SET 1: ALBANIA 2: ANDORRA 3: ARGENTINA 4: AUSTRALIA 5: BANGLADESH 6: BHUTAN 7: BOLIVIA 8: BOSNIA_HERZENGOVINA 9: BRAZIL 10: CANADA 11: CAMBODIA 12: CHILE 13: CHINA 14: COLOMBIA 15: DOMINICAN_REPUBLIC 16: ECUADOR 17: EL_SALVADOR 18: GREAT_BRITAIN, 19: EUROPEAN_UNION 20: GAUTEMALA 21: GUAM 22: HONG_KONG 23: INDIA 24: INDONESIA 25: JAPAN_1W_LBT 26: JAPAN_250MW 27: LAOS_EU 28: LAOS_FCC 29: MACAU 30: MACEDONIA 31: MALAYSIA 32: MEXICO 33: MONACO 34: MOTENEGRO 35: NEW_ZEALAND_FCC 36: NEW_ZEALAND_EU 37: PAKISTAN 38: PANAMA 39: PARAGUAY 40: PERU 41: PHILIPPINES 42: PUERTO_RICO 43: RUSSIA 44: SAUDI_ARABIA 45: SINGAPORE 46: SOUTH_AFRICA 47: SOUTH_KOREA 48: SRI_LANKA 49: TAIWAN 50: THAILAND 51: TURKEY 52: UAE 53: UNITED_STATES 54: URUGUAY 55: VENEZUELA 56: VIETNAM 57: VIRGINIA_ISLAND 58: ETSI 59: FCC 60: ISRAEL 61: ALGERIA 62: ARMENIA 63: AUSTRIA 64: AZERBAIJAN 65: BAHRAIN 66: BELGIUM 67: BULGARIA 68: COSTA_RICA 69: CROATIA 70: CYPRUS 71: CZECH_REPUBLIC 72: DENMARK		

Data Dictionary

Attribute Number	Attribute Name	Description	Type	Size (Byte)	Values	Default Value	User Mode Access
					73: EGYPT 74: ESTONIA 75: FINLAND 76: FRANCE 77: GEORGIA 78: GERMANY 79: GREECE 80: HUNGARY 81: ICELAND 82: IRELAND 83: ITALY 84: JORDAN 85: KAZAKHSTAN 86: KUWAIT 87: LATVIA 88: LITHUANIA 89: LUXEMBOURG 90: MALTA 91: NETHERLANDS 92: NORWAY 93: OMAN 94: POLAND 95: PORTUGAL 96: QATAR 97: ROMANIA 98: SERBIA 99: SLOVAKIA 100: SLOVEN 101: SPAIN 102: SWEDEN 103: SWITZERLAND 104: TUNISIA 105: UKRAINE }	0	RW
1584	ATT_RFID_HOPPING_ENABLED	Enable channel hopping. Applicable only if regulatory allows it to be configurable.	'B'	1	0 -1(0:Disable 1:Enable)	1	RW
DWORD PARAMS							
1647	ATT_RFID_REG_C_HNL_LOWER_MASK	Bit mask for enabled channels. Least significant bit represents lower most channels.	'D'	4	0 - 4294967295	0x000f	RW
1648	1648 ATT_RFID_REG_C_HNL_UPPER_MASK		'D'	4	0 - 4294967295	0x0000	RW

Peripheral Configurations

Table 17 Peripheral Configurations

Attribute Number	Attribute Name	Description	Type	Size (Byte)	Values	Default Value	User Mode Access
BYTE PARAMS							
1607	ATT_RFID_UUID_CONFIG_ORDER	To determine UUID order	'B'	1	0 -1(0:Configure SPP UUID first 1: Configure CUSTOM UUID first)	1	RW

Trigger Configurations

Table 18 Trigger Configurations

Attribute Number	Attribute Name	Description	Type	Size (Byte)	Values	Default Value	User Mode Access
BYTE PARAMS							
1593	ATT_RFID_START_ON_TRIGGER	Control RFID operation start based on external hand-held trigger	'B'	1	0 - 1(0:Disable 1:Enable)	0	RW
1594	ATT_RFID_START_TRIGGER_TYPE	Control operation start based on press or release of trigger	'B'	1	0 - 1 (0: Start on trigger press 1: Start on trigger release)	0	RW
1595	ATT_RFID_REPEAT_START	Should operation be repeated by monitoring for start trigger condition after a stop trigger condition is met	'B'	1	0 - 1(0: Repeat start trigger monitoring 1: Do not repeat start trigger)	0	RW
1596	ATT_RFID_STOP_ON_TRIGGER	Control RFID operation stop based on external hand-held trigger	'B'	1	0 - 1(0:Disable 1:Enable)	0	RW
1597	ATT_RFID_STOP_TRIGGER_TYPE	Control operation stop based on press or release of trigger	'B'	1	0 - 1(0: Stop on trigger pull 1: Stop on trigger release)	0	RW
1598	ATT_RFID_STOP_ON_TAG_COUNT	Control RFID operation stop based on tag seen count	'B'	1	0 - 1(0: Do not stop on tag seen count 1: Stop on tag seen count)	0	RW
1599	ATT_RFID_STOP_ON_TIMEOUT	Control RFID operation stop based on a timeout	'B'	1	0 - 1(0: Do not stop on timeout 1: Stop on timeout)	0	RW
1600	ATT_RFID_STOP_ON_INV_COUNT	Control RFID operation stop based on completion of specified number of inventory rounds	'B'	1	0 - 1(0: Do not stop on inventory count 1: Stop on inventory count)	0	RW
WORD PARAMS							

Data Dictionary

Attribute Number	Attribute Name	Description	Type	Size (Byte)	Values	Default Value	User Mode Access
1635	ATT_RFID_TRIGGER_START_DELAY	Delay in milli-seconds from start of trigger to initiate the operation. 0 means no delay.	'W'	2	0 - 65535	0	RW
1636	ATT_RFID_STOP_TAG_COUNT	Count of tags to monitor before stopping.	'W'	2	0 - 65535	0	RW
1637	ATT_RFID_STOP_INV_COUNT	Number of inventory rounds	'W'	2	0 - 65535	0	RW
DWORD PARAMS							
1649	ATT_RFID_TRIGGER_STOP_TIMEOUT	Timeout value for stop trigger	'D'	4	0 - 4294967295	0	RW

ASCII Configurations

Table 19 ASCII Configurations

Attribute Number	Attribute Name	Description	Type	Size (Byte)	Values	Default Value	User Mode Access
BYTE PARAMS							
1601	ATT_RFID_ASCII_ECO_OFF_ON	Controls whether input from host is echoed back to host in ZETI communication. Useful for terminal based hosts to see what is typed and transmitted to the reader.	'B'	1	0 - 1(0: Enable ZETI Echo 1: Turn off ZETI Echo)	1	RW
1602	ATT_RFID_ASCII_CRC_ON_OFF	Control whether CRC field is enabled in ZETI communication. If enabled, a CRC field is added to each line of response from the reader.	'B'	1	0 - 1(0: Turn off ZETI CRC 1: Enable ZETI CRC)	0	RW
1603	ATT_RFID_ASCII_DEBUG_INTERFACE		'B'	1	0 - 255	0	RW
1604	ATT_RFID_ASCII_DEBUG_ON_OFF		'B'	1	0 - 255	0	RW
1605	ATT_RFID_ASCII_DEBUG_LEVEL		'B'	1	0 - 255	3	RW
1606	ATT_RFID_ASCII_OPERATION_END_NOTIFICATION_ON_OFF	Enable or Disable operation end notification messages from reader over ZETI interface for RFID operations	'B'	1	0 - 1(0: Turn off Operation End Notification 1: Enable Operation End Notification)	0	RW

Data Dictionary

Attribute Number	Attribute Name	Description	Type	Size (Byte)	Values	Default Value	User Mode Access
1608	ATT_RFID_ASCII_START_OPR_NOTIFY_ON_OFF	Enable or Disable notification messages from reader over ZETI interface after every operation start	'B'	1	0 - 1(0: Turn off Operation Start Notification 1: Enable Operation Start Notification)	0	RW
1609	ATT_RFID_ASCII_STOP_OPR_NOTIFY_ON_OFF	Enable or Disable notification messages from reader over ZETI interface after every operation stop	'B'	1	0 - 1(0: Turn off Operation Stop Notification 1: Enable Operation Stop Notification)	0	RW
1668	ATT_RFID_ASCII_TRIGGER_NOTIFY_ON_OFF		'B'	1	0 - 1(0: Turn off Notification 1: Turn on Notification)	1	RW
1669	ATT_RFID_ASCII_BATTERY_NOTIFY_ON_OFF		'B'	1	0 - 1(0: Turn off Notification 1: Turn on Notification)	1	RW
1670	ATT_RFID_ASCII_TEMPERATURE_NOTIFY_ON_OFF		'B'	1	0 - 1(0: Turn off Notification 1: Turn on Notification)	1	RW
1671	ATT_RFID_ASCII_POWER_NOTIFY_ON_OFF		'B'	1	0 - 1(0: Turn off Notification 1: Turn on Notification)	0	RW
1680	ATT_RFID_ASCII_DATABASE_NOTIFY_ON_OFF		'B'	1	0 - 1(0: Turn off Notification 1: Turn on Notification)	0	RW
1681	ATT_RFID_ASCII_RADIO_ERR_NOTIFY_ON_OFF		'B'	1	0 - 1(0: Turn off Notification 1: Turn on Notification)	0	RW
1685	ATT_RFID_ASCII_BATCH_MODE_NOTIFY_ON_OFF		'B'	1	0 - 1(0: Turn off Notification 1: Turn on Notification)	1	RW

Tag Access Criteria Configurations

Table 20 Tag Access Criteria Configurations

Attribute Number	Attribute Name	Description	Type	Size (Byte)	Values	Default Value	User Mode Access
BYTE PARAMS							
1610	ATT_RFID_ACCES S1_ENABLE	Enable or Disable RFID Access Operation filter	'B'	1	0 - 1(0: Disable Access Filter 1: Enable Access Filter)		
1611	ATT_RFID_ACCES S1_FILTER1_MEMB ANK	Memory Bank for first filter	'B'	1	0 - 3(0:Reserved 1:EPC 2:TID 3:USER)	3	RW
1612	ATT_RFID_ACCES S1_FILTER1_DOMA TCH	Should operation be done on tags matching the filter or on those not matching the filter	'B'	1	0 - 1(0: Disable Access Filter 1: Enable filter match)	0	RW
1613	ATT_RFID_ACCES S1_FILTER2_MEMB ANK	Memory Bank for second filter	'B'	1	0 - 3(0:Reserved 1:EPC 2:TID 3:USER)	3	RW
1614	ATT_RFID_ACCES S1_FILTER2_DOMA TCH	Should operation be done on tags matching the filter or on those not matching the filter	'B'	1	0 - 1(0: Disable Access Filter 1: Enable filter match)	0	RW
WORD PARAMS							
1638	ATT_RFID_ACCES S1_FILTER1_STAR T_POS	Start position in bits from beginning of memory bank from where match needs to be performed.	'W'	2	0 to 65535	0	RW
1639	ATT_RFID_ACCES S1_FILTER1_MATC H_LENGTH	Numbers of bits from start position to use for matching.	'W'	2	0 to 65535	16	RW
1640	ATT_RFID_ACCES S1_FILTER2_STAR T_POS	Start position in bits from beginning of memory bank from where match needs to be performed.	'W'	2	0 to 65535	0	RW
1641	ATT_RFID_ACCES S1_FILTER2_MATC H_LENGTH	Numbers of bits from start position to use for matching.	'W'	2	0 to 65535	16	RW

Power Mode Configurations

Table 24 Power Mode Configurations

Attribute Number	Attribute Name	Description	Type	Size (Byte)	Values	Default Value	User Mode Access
BYTE PARAMS							
1765	ATT_BATT_DISCO NNECT_EN	Idle timeout in low power mode after which device automatically powers off	'B'	2	0 - disable, 26 - 10 Minutes, 27 - 15 Minutes, 28 - 20 Minutes, 29 - 30 Minutes, 30 - 45 Seconds, 33 - 1 Hour, 34 - 2 Hours, 36 - 4 hours note: additional 5 minutes is added for the above timeout (for example, if 10 mins is selected, it takes 15 mins to go to off mode).	35 min	RW
1785	ATT_RFID_LED_MO DE	(See section LED Modes, Table 17)	'B'	2	0 - 3	1	RW
1786	ATT_RFID_LED_MO DE	When trigger is pressed, the LED must almost immediately "flash ON- a blink" to indicate the battery state of charge. The LED stays ON 0.3 sec by default. This time window is configurable from 0.1 sec to 3 sec.	'B'	2	1 - 30	0.3sec (unit is tenths of a second)	RW
1788	ATT_BATTERY_ST ATUS_LED_DURAT ION	Regardless of the LED mode, upon removing sled from charging cradle, the battery state of charge is displayed	'B'	2	0 - 50 sec	4 sec	RW
WORD PARAMS							
1632	ATT_RFID_LOW_P OWER_MODE_TIM EOUT	Idle timeout after which unit goes into low power mode	'W'	2	5 - 65535	5 min	RW
1633	ATT_RFID_OFF_M ODE_TIMEOUT	Idle timeout in low power mode after which device automatically powers off	'W'	2	5 - 65535	300 sec	RW

Unique Tag Report Configurations

Table 25 Unique Tag Report Configurations

Attribute Number	Attribute Name	Description	Type	Size (Byte)	Values	Default Value	User Mode Access
BYTE PARAMS							
1580	ATT_RFID_UNIQUE_TAG_REPORT	Enable or Disable reporting of unique tags only	'B'	1	0 - 1(0:Disable 1:Enable)	0	RW

Other RFID Configurations

Table 26 Other RFID Configurations

Attribute Number	Attribute Name	Description	Type	Size (Byte)	Values	Default Value	User Mode Access
BYTE PARAMS							
1615	ATT_RFID_BUFFER_SIZE		'B'	1	6 - 50	10	RW
1616	ATT_RFID_INV_CYCLES		'B'	1	0 - 255	4	RW
1617	ATT_RFID_KTX		'B'	1	0 - 255	4	RW
1618	ATT_RFID_KS		'B'	1	0 - 255	5	RW

System Configurations

Table 27 System Configurations

Attribute Number	Attribute Name	Description	Type	Size (Byte)	Values	Default Value	User Mode Access
BIT PARAMS							
1664	ATT_GENX_MODE_SELECT	RFID mode	'F'	1 Bit	0 (0:RFID)	0	RW
56	ATT_DEC_BEEP	Sound beeper on successful RFID operation	'F'	1 Bit	0 - 1	1	RW
STRING PARAMS							
533	ATT_MODEL_NUMBER	Model number	'S'	19	Variable (Sequence of bytes. Maximum 19 bytes)	'R','F','D','2','0','0','0','-','X','X','X','X','X','X','X','X','X'	RO
534	534 ATT_SERIAL_NUMBER	Serial number	'S'	17	Variable (Sequence of bytes. Maximum 17 bytes)	'X','X','X','X','X','X','X','X','X','X','X','X','X','X','X','X','X'	RO

Data Dictionary

Attribute Number	Attribute Name	Description	Type	Size (Byte)	Values	Default Value	User Mode Access
535	ATT_DATE_OF_MANUFACTURE	Date of manufacture	'S'	8	Variable (Sequence of bytes. Maximum 8 bytes)	'D','D','M','M','M','Y','Y'	
536	ATT_DATE_OF_SERVICE	Date of last service	'S'	8	Variable (Sequence of bytes. Maximum 8 bytes)	'D','D','M','M','M','Y','Y'	
614	ATT_DATE_FIRST_PROGRAM	Date of first programming	'S'	8	Variable (Sequence of bytes. Maximum 8 bytes)	'D','D','M','M','M','Y','Y'	RW
616	ATT_CONFIG_FILE	Identifies the device configuration	'S'	17	Variable (Sequence of bytes. Maximum 17 bytes)	'F', 'a', 'c', 't', 'o', 'r', 'y', '', 'D', 'e', 'f', 'a', 'u', 'l', 't', 0x03	RW
20004	ATT_FIRM_VERSION	Firmware version string	'S'				RO
ACTION PARAMS							
6001	ATT_SET_DEFAULTS	Initiates a parameter defaults command	'X'	1			WO
6004	ATT_REBOOT	Remote reboot command	'X'	1			WO

Action Values

Table 28 Possible Select Action Values

Action	Matching	Non-Matching
0 (default)	Assert SL or Inventoried - A	De-assert SL or Inventoried - B
1	Assert SL or Inventoried - A	Do nothing
2	Do nothing	De-assert SL or Inventoried - B
3	Negate SL or (A - B, B - A)	Do nothing
4	De-assert SL or Inventoried - B	Assert SL or Inventoried - A
5	De-assert SL or Inventoried - B	Do Nothing
6	Do nothing	Assert SL or Inventoried - A
7	Do nothing	Negate SL or (A - B, B - A)

Index

A		
applications		
rfid for android		
about screen	41	
access control screen	39	
antenna	30	
battery	35	
beeper	37	
inventory screen	24	
locate tag screen	26	
pre filters screen	40	
rapid read screen	23	
readers list screen	28	
save configuration	38	
settings screen	27	
singulation control	31	
start/stop triggers	32	
tag reporting	33	
using rfid for android	20	
B		
battery		
maintenance	76	
management	18	
notification	18	
optimization	18	
C		
conventions		
notational	8	
D		
d	32	
data dictionary	79	
documents	9	
dpo	25, 27, 36	
F		
feature	18	
H		
hand-held	32	
I		
information, service	9	
L		
lanyard	11, 17	
M		
maintenance	75	
P		
power management	25, 27, 36	
R		
rfid manager	42	
firmware update	49	
import into stagenow	61	
installation	43	
recovery mode	51	
rfid scan-scan-write	54	
rfid sled		
cleaning	74	
configurations	7	
features	11	
maintenance	75	
troubleshooting	76	
rsssi	33	

S

service information9
software9
stagenow59

T

tag reporting
 rssi33
troubleshooting76
 default configuration76
 LED mode 278

U

unpacking10
using
 rfid for android20

