



**Zebra® P630*i*/P640*i***  
Card Printer

**User's Manual**



---

# Foreword



This manual contains installation and operation information for the Zebra P630*i* and P640*i* card printers manufactured by Zebra Technologies Corporation.

## Copyright Notice

© 2006, ZIH Corp.

This document contains information proprietary to Zebra Technologies Corporation. This document and the information contained within is Copyrighted by Zebra Technologies Corporation and may not be duplicated in full or in part by any person without written approval from Zebra Technologies Corporation. While every effort has been made to keep the information contained within current and accurate as of the date of publication, no guarantee is given that the document is error-free or that it is accurate with regard to any specification. Zebra Technologies Corporation reserves the right to make changes, for the purpose of product improvement, at any time.

## Trademarks

Zebra is a registered trademark of Zebra Technologies Corporation. Windows and MS.DOS are registered trademarks of Microsoft Corp. All other trademarks or registered trademarks are marks of their respective holders.

## Product Disposal

**Product Disposal Information** • Do not dispose of this product in unsorted municipal waste. This product is recyclable, and should be recycled according to your local standards. For more information, please see our web site at:

<http://www.zebra.com/environment>

## Return Materials Authorization

Before returning any equipment to Zebra Technologies Corporation for in-warranty or out-of-warranty repair, contact Repair Administration for a Return Materials Authorization (RMA) number. Repack the equipment in the original packing material and mark the RMA number clearly on the outside. Ship the equipment, freight prepaid, to the address listed below:

- For USA, Latin America, and Asia / Pacific:

Zebra Technologies Corporation  
Zebra Card Printer Solutions  
1001 Flynn Road  
Camarillo, CA. 93012-8706.USA  
Phone: +1 (805) 578-5001  
FAX: +1 (805) 579-1808

- For Europe and Middle East:

Zebra Technologies Corporation  
Zebra Card Printer Solutions  
Pittman Way, Fulwood  
Preston, PR2 9ZD  
Lancashire, U.K.  
Phone: +44 - 1 - 772 - 797555  
FAX: +44 - 1 - 772 - 693000

## Declarations of Conformity



89/336/EEC modified by 92/31/EEC and 93/68/EEC	EMC Directive	EN 55022 (1998)	RF Emissions control
	EMC Directive	EN 301489-3 V1.4.1	RF Emissions and Immunity for radio equipment
	EMC Directive	EN55024 (2001)	Immunity to Electro-Magnetic Disturbances
73/23/EEC modified by 93/68/EEC	Low voltage Directive	EN 60950-1 (2001)	Product safety
1999/5/CE	R&TTE Directive	EN300330-2 V1.1.1	Radio Frequency Interferences

For a formal certificate, please contact the Compliance Office at Zebra's Camarillo facility.

**EUROPE:** Norway Only: This product is also designed for IT power system with phase to phase voltage 230V. Earth grounding is via the polarized, 3-wire power cord.

FI: "Laite on liitettävä suojamaadoitus koskettimilla varustettuun pistorasiaan"

SE: "Apparaten skall anslutas till jordat uttag"

NO: "Apparatet må tilkoples jordet stikkontakt"

### FCC - DECLARATION OF CONFORMITY

Models P630*i* and P640*i* have been tested and found to comply with the limits for a Class A device, pursuant to Part 15 of the FCC Rules. These limits are designed to provide reasonable protection against harmful interference when the equipment is operated in a commercial environment. This equipment generates, uses, and can radiate radio frequency energy and, if not installed and operated in accordance with the P630*i* / P640*i* User's Manual (this document), may cause harmful interference to radio communications. Operation of this equipment in a residential area is likely to cause harmful interference, in which case the user will be required to correct the interference at his own expense.

### INDUSTRY CANADA NOTICE

This device complies with Industry Canada ICES-003 class A requirements.

Cet équipement est conforme a l'ICES-003 classe A de la norm Industrielle Canadian.

## Icons

Throughout this manual, different icons highlight important information, as follows:



**Note** • Indicates information that emphasizes or supplements important points of the main text.



**Important** • Advises you of information that is essential to complete a task, or points out the importance of specific information in the text.



**Electric Shock Caution** • Warns you of a potential electric shock situation.



**Electrostatic Discharge Caution** • Warns you of a situation where electrostatic discharge could cause damage to electronic components.



**Caution** • Advises you that failure to take or avoid a specific action could result in physical harm to you, or could result in physical damage to the hardware.



**Pinch Hazard** • Keep fingers away from printer cover hinges and back of cleaning cassette.



**Hot Surface** • Danger of skin burns near laminator components.

# P630i and P640i Printer Models

The Zebra Product Number tells a story. Model numbers include identifiers that specify options using the following conventions:

Part Number	Description
P 6 3 0 i - _ _ _ _ _ - _ _ _ _	<b>Base Printer</b> P630i Dual-Sided Color Card Printer w/Single Linerless Laminator
P 6 3 0 is- _ _ _ _ _ - _ _ _ _	P630iS Dual-Sided Color Card Printer w/Single Linerless Laminator with Advanced ID/Key Security Feature
P 6 4 0 i - _ _ _ _ _ - _ _ _ _	<b>Base Printer</b> P640i Dual-Sided Color Card Printer w/Dual Linerless Laminator
P 6 4 0 is- _ _ _ _ _ - _ _ _ _	P640iS Dual-Sided Color Card Printer w/Dual Linerless Laminator with Advanced ID/Key Security Feature
_ _ _ _ _ - 0 _ _ _ _ - _ _ _ _	<b>Smart Card Options</b> None
_ _ _ _ _ - B _ _ _ _ - _ _ _ _	Contact Encoder
_ _ _ _ _ - D _ _ _ _ - _ _ _ _	Contact encoder & MIFARE contactless
_ _ _ _ _ - E _ _ _ _ - _ _ _ _	Contact Station
_ _ _ _ _ - H _ _ _ _ - _ _ _ _	MIFARE contactless
_ _ _ _ _ - 0 _ _ _ _ - _ _ _ _	<b>Magnetic Encoder</b> None
_ _ _ _ _ - M _ _ _ _ - _ _ _ _	Yes (select defaults below)
_ _ _ _ _ - 0 _ _ _ _ - _ _ _ _	<b>Magnetic Encoder Defaults</b> None
_ _ _ _ _ - 3 _ _ _ _ - _ _ _ _	Stripe Up, HiCo
_ _ _ _ _ - 0 _ _ _ _ - _ _ _ _	<b>Memory Expansion</b> None
_ _ _ _ _ - _ _ _ _ A - _ _ _ _	<b>Interface</b> USB Standard Configuration)
_ _ _ _ _ - _ _ _ _ C - _ _ _ _	USB & Built-InEthernet 10/100T
_ _ _ _ _ - _ _ _ _ U - _ _ _ _	USB and Parallel (Minimum Printer Order Applies)
_ _ _ _ _ - _ _ _ _ I _ _ _ _	<b>Power Cords</b> 120V A.C. US & 230V A.C. European
_ _ _ _ _ - _ _ _ _ U _ _ _ _	U. K. and Australia
_ _ _ _ _ - _ _ _ _ D _ _ _ _	<b>Windows Drivers and User Documentation / Training</b> Windows Driver CD (Win 2K and XP) & User Documentation & Training CD
_ _ _ _ _ - _ _ _ _ G _ _ _ _	<b>RoHS</b> Compliant



## Foreword

P630i and P640i Printer Models



---

# Contents



<b>Foreword</b> .....	<b>i</b>
Copyright Notice .....	i
Trademarks .....	i
Return Materials Authorization .....	ii
Declarations of Conformity .....	iii
Icons .....	iv
P630i and P640i Printer Models .....	v
<b>1 • Introduction</b> .....	<b>1</b>
Printer Features .....	2
Controls and Indicators .....	3
Control Panel Buttons .....	3
Control Panel Indicators .....	5
Rear of Printer .....	6
<b>2 • Installation</b> .....	<b>7</b>
Introduction .....	7
Installation Procedure .....	7
Remove the Printer from the Shipping Carton .....	7
Remove Shipping Tape .....	10
Attach the Output Hopper .....	11
Attach the Ribbon Take-Up Spool .....	11
Connecting Power .....	12
Ribbon Installation .....	12
Installing the Cleaning Cassette .....	16
Loading Laminate .....	17
Loading the Laminate Cassette(s) .....	20

Using Partial-Width Laminate . . . . .	22
Installing the Laminator Cassette(s) . . . . .	24
Clearing the Laminate Channels . . . . .	25
Loading Cards . . . . .	26
Connecting the Interface. . . . .	29
<b>3 • Printer Driver Installation. . . . .</b>	<b>31</b>
Overview . . . . .	31
Installing the Printer Driver (USB). . . . .	32
Installing the Printer Driver (Ethernet). . . . .	41
<b>4 • Settings and Adjustments . . . . .</b>	<b>51</b>
Introduction . . . . .	51
Sensors and Interlock Switches . . . . .	51
Access Printer Sensor Data . . . . .	52
Printer Properties . . . . .	54
General . . . . .	54
Sharing . . . . .	54
Ports . . . . .	55
Advanced . . . . .	55
Color Management . . . . .	56
Security . . . . .	56
Device Settings. . . . .	57
Printing Preferences . . . . .	59
Card Setup . . . . .	60
Image Adjustment. . . . .	61
YMC (Color) Printing. . . . .	62
K (Black) Panel. . . . .	62
Color Calibration . . . . .	64
Flip Station Routines. . . . .	65
Laminator Station Adjustments . . . . .	66
<b>5 • Troubleshooting . . . . .</b>	<b>69</b>
Error Messages. . . . .	69
Indicator Light Status . . . . .	70
Preventive Maintenance . . . . .	70
Unusual Noises/Unreported Events . . . . .	71
Quality Problems. . . . .	73
Laminate Problems. . . . .	75
Examples of Printhead Failures . . . . .	75
System Related Issues . . . . .	76
Invalid IP address . . . . .	76
DHCP is enabled but the printer is not connected to your network . . . . .	77

Valid host name has not been assigned to the printer . . . . .	77
Color differences may be attributable to the Windows operating system installed . . .	77
<b>6 • Technical Specifications . . . . .</b>	<b>79</b>
P640i Specifications . . . . .	79
<b>Appendix A • Magnetic Encoder. . . . .</b>	<b>81</b>
Magnetic Card Stripe Encoder . . . . .	81
ISO Standard Encoding . . . . .	81
AAMVA Standard Encoding . . . . .	82
Magnetic Encoder Cleaning . . . . .	82
Media Loading Orientation . . . . .	82
<b>Appendix B • Smart Card Contact Station. . . . .</b>	<b>83</b>
Introduction . . . . .	83
Media Loading Orientation . . . . .	83
Laminating Smart Cards . . . . .	84
<b>Appendix C • Printer Security. . . . .</b>	<b>85</b>
ID/Key . . . . .	85
Replacing a Lost ID/Key . . . . .	85
Printer Parameters in the Driver . . . . .	86
ID/Code . . . . .	86
Update Backup Config . . . . .	86
Restoring the Backup Configuration Settings . . . . .	86
Password Protection . . . . .	87
<b>Appendix D • Worldwide Sales &amp; Support. . . . .</b>	<b>89</b>
Sales and Support Locations . . . . .	89
Corporate Headquarters . . . . .	90
Website . . . . .	90





---

# Introduction

Thank you for choosing the Zebra P630*i* or P640*i* Card Printer. This manual guides you to efficient start up and operation of your new Card Printer.

The Zebra P630*i* and P640*i* Card Printers provide high speed, full color dual-sided card printing. A micro-positioning card transport system provides enhanced color photos. A range of interface, encoder/reader, and security options allow ordering the specific configuration suitable for a particular application.

The difference between the P630*i* and the P640*i* is that the P630*i* has a single-sided laminator (i.e., it lays down and seals a laminating film on the top surface of the printed card), while the P640*i* has a dual-sided laminator (i.e., it lays down and seals laminating film on both surfaces of the printed card).

References in this document that refer to either or both of the models will be in the form of “the printer” or “the P630*i*/P640*i* Printer”; references that are specific to one or the other will be in the form of “the P630*i* Printer” or “the P640*i* Printer.”

## Printer Features

The following figure shows features of the P630i/P640i Printer.

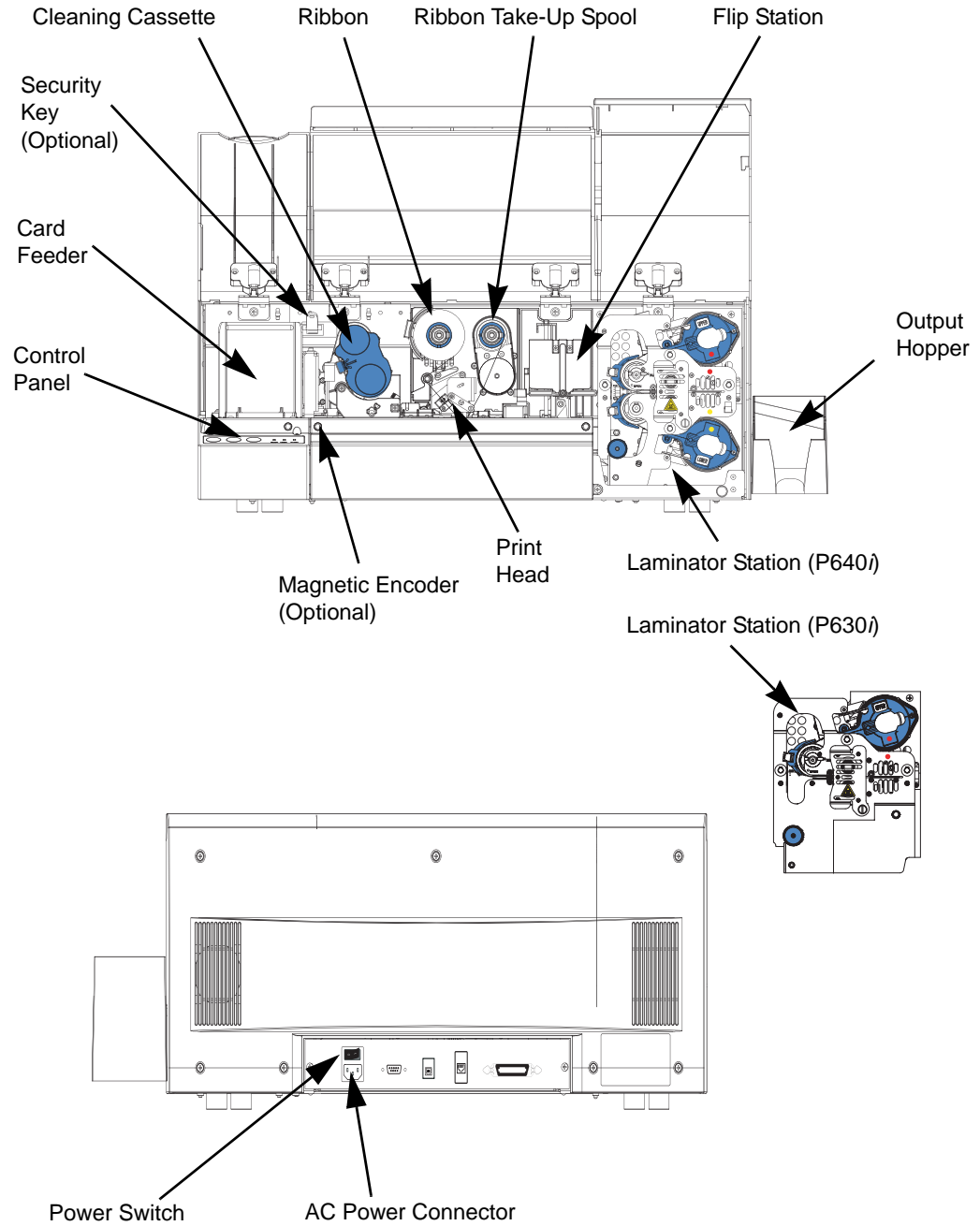

## Controls and Indicators

### Control Panel Buttons

A limited amount of control and status information is available at the Control Panel on the front of the printer. Additional control functions and status information is available via the host or networked computer(s).

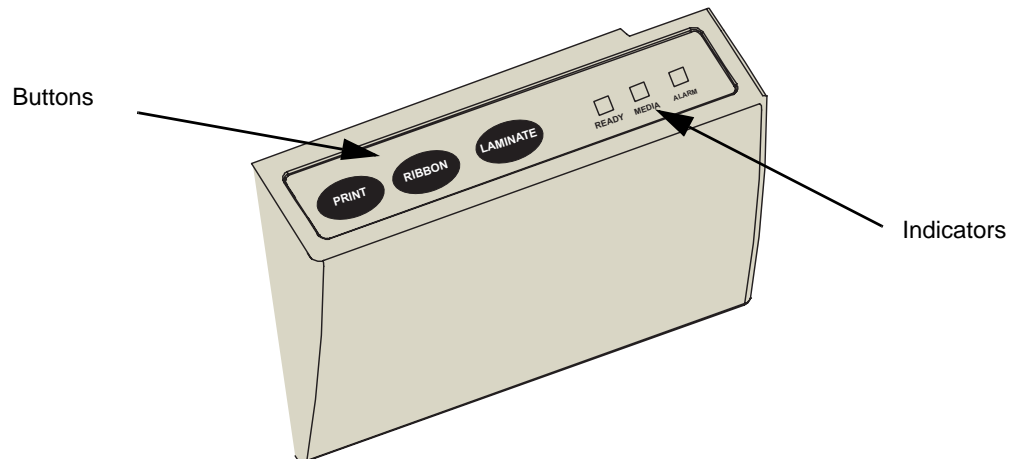

### PRINT Button

Press the **PRINT** button to print the image stored in the printer's memory. When the printer is powered up, the memory is loaded with a checkerboard test pattern.

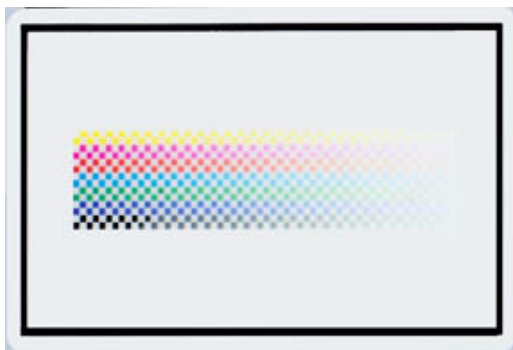

In regular on-line use, the **PRINT** button reprints the last image downloaded from the computer to the buffer memory. If you hold the **PRINT** button down and power up the printer, the Ribbon Synchronization feature (which normally forces a ribbon synchronization whenever the door is closed or the printer is powered up) is disabled.

If you press and hold the **PRINT** button for more than two seconds, the printer will continuously reprint the image in the buffer. Stop this action by pressing the button momentarily while printing is in process.

Note that pressing the **PRINT** button will have no effect if any of the following applies:

- An error condition exists
- You have set up the print driver to print color on both sides of the card
- The optional hardware lockout key, ID/Key, is missing (but this does not disable the checkerboard printout available after power-up).

### **RIBBON button**

This button is used to synchronize the ribbon – in other words, to position it correctly under the print head. If you hold the **RIBBON** button down and power up the printer, it toggles on/off the Ribbon Synchronization feature when the door is closed.

In typical applications, the ribbon type is YMCK, and the back of the card is printed first. In such cases, pressing the **RIBBON** button will advance the color ribbon to bring the leading edge of the next black panel under the print head.

If back side printing is not enabled, the printer will synchronize on the next yellow panel when the **RIBBON** button is pressed.

### **LAMINATE button**

(For the P640i Printer, this applies to the Upper and Lower Laminator; the P630i Printer has only the Upper Laminator.)

If either (or both) of the laminate transfer rollers is not loaded with a laminate patch, then pressing the **LAMINATE** button will correct the condition, provided the cassette is not out of laminate, and if the cassette latch is closed (locked). If both transfer rollers are already loaded, the **LAMINATE** button has no effect. If you hold the **LAMINATE** button down and power up the printer, it toggles on/off the Ribbon Synchronization feature when the printer is powered up.

A typical use of the **LAMINATE** button is in reloading a transfer roller after removing the first hand-cut patch of laminate following installation of a fresh roll.



## Control Panel Indicators

Depending on the condition they are reporting, the three indicator lights, READY, MEDIA, and ALARM, can be in one of three states: Off, On (steady), or Flashing.



**Note** • The READY indicator is bi-colored. Its two color channels, **green** and **yellow**, function independently.

<b>READY Indicator</b>	<b>Green:</b>	Steady = Ready to print Flashing = Printer busy
	<b>Yellow:</b>	Steady = Laminator(s) in sleep mode Flashing = Laminator(s) not at operating temperature
<b>MEDIA Indicator</b>	<b>Off:</b>	Normal
	<b>On:</b>	Steady = Any media outage Flashing = Magnetic encoding failure
<b>ALARM Indicator</b>	<b>Off:</b>	Normal
	<b>On:</b>	Steady = Error condition requiring intervention  Flashing = Printhead temperature error, or major internal control problem requiring power cycling of the printer (OFF, pause, then ON)

= LIGHT ON

= LIGHT FLASHING

READY		MEDIA	ALARM	PRINTER STATUS
GREEN	YELLOW	ORANGE	RED	
				Ready to print
				Printer busy
				Laminator heating up, but not yet at operating temperature
				Laminator heaters in sleep mode (when not in use, the heaters cool at 1°F per minute)
				Printhead temperature error, or internal firmware problem.
				No cards in hopper, color ribbon out, cleaning tape out, laminator cassette(s) out.
				Magnetic encoding write failure
				Serious error conditions, including: Main cover open, Laminator too hot, card transport stalled, card not seated properly, magnetic encoding verification error, head lift failure, ribbon jam, card jam (any location), card missing (any location), no gap between laminator patches.

## Rear of Printer

The Power Connector, Power Switch, and Interface Connector(s) are located on the rear of the printer, as shown below.

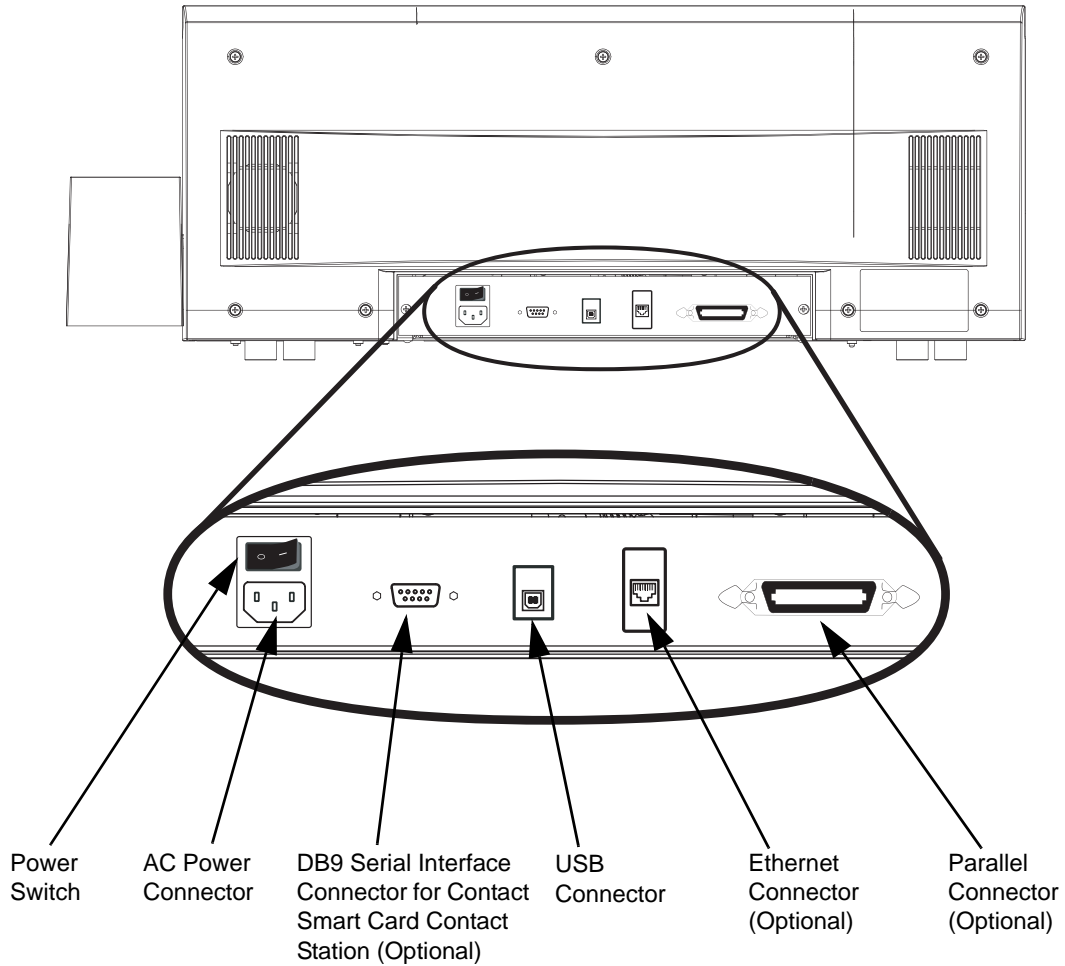



---

# Installation

## Introduction

Installation includes setting up the printer, installing the printer driver in the computer(s) that will be sending print jobs to the printer, connecting the interface, installing the Cleaning Cartridge, loading the cards, ribbon, and laminate, and verifying that the printer can print a test card.

Loading the Printer Driver software is described in Section 3.

## Installation Procedure



---

**Important** • Execute the procedures that follow in the order given.

---

### Remove the Printer from the Shipping Carton

**Step 1.** Open and remove the plastic handle/latches on either end of the shipping carton.

**Step 2.** Lift the upper part of the shipping carton off the lower part.

**Step 3.** Remove the items from the cutouts in the foam block atop the printer. Verify that the following items are included:

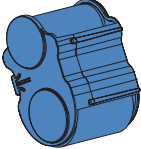
Printed Quick-Start Guide	
Cleaning Cartridge	
Output Hopper	
Ribbon Take-up Spool	
Two Power Cords	
Card Weight	
Documentation & Driver CD	
USB Interface Cable	

**Step 4.** Remove the foam block from the top of the shipping carton.

**Step 5.** Lift the printer from the shipping carton.



---

**Caution** • The printer weighs approximately 15.9 kg (35 lbs).

---

**Step 6.** Remove the protective plastic bag from the printer.



---

**Important** • Save all the packing material and the shipping carton in case the printer needs to be moved or shipped. If the original material is lost or damaged, a replacement Shipping Kit can be ordered from Zebra.

---

**Step 7.** Place the printer in a location that meets the following requirements:

- A reasonably dust- and dirt-free environment will give better print quality.
- Flat surface at least 699 mm (27.5 in) x 246 mm (9.7 in) that can support the weight of the printer; additional space preferred. Vertical clearance at least 450 mm (17 in). There should be easy access to all sides of the printer.
- Temperature within the range of 10° to 35°C (50° to 95°F).
- Relative Humidity 20 to 80%, non-condensing.
- AC power accessible.

## Remove Shipping Tape

- Step 1.** Open the printer Main Cover. Locate and remove the blue tape that secures the flip station in position.

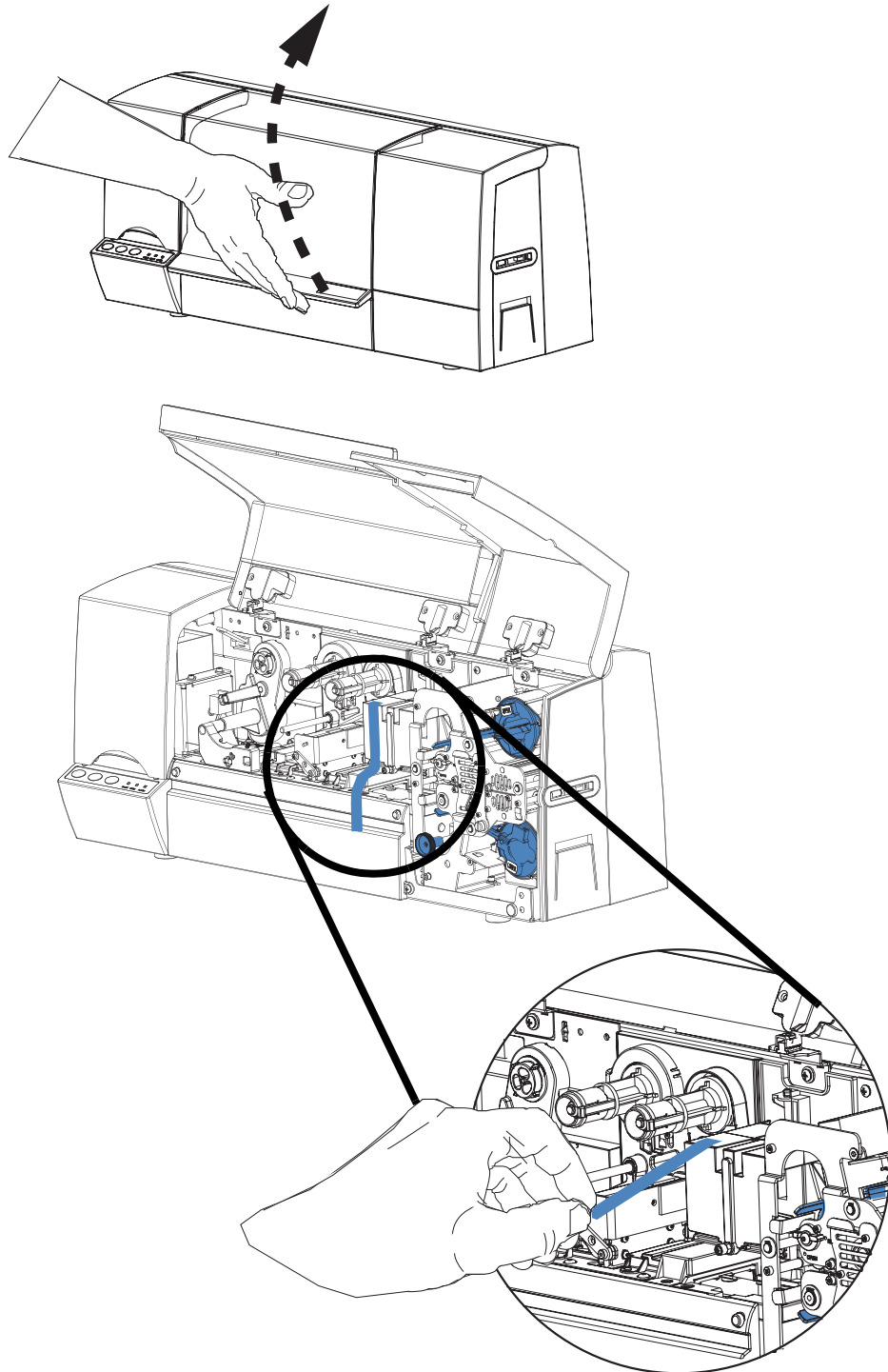

## Attach the Output Hopper

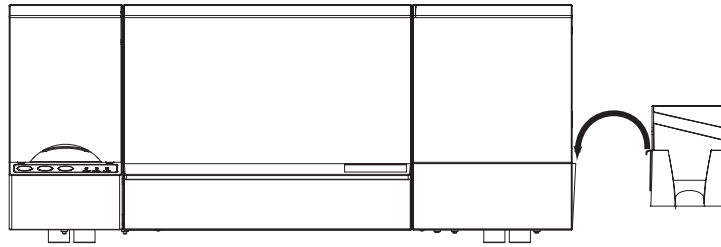

- Step 1.** The Output Hopper is positioned on the right side of the printer to receive the printed cards. Install the Output Hopper by inserting the tab on the side of the Output Hopper into the slot on the right side of the printer.

## Attach the Ribbon Take-Up Spool

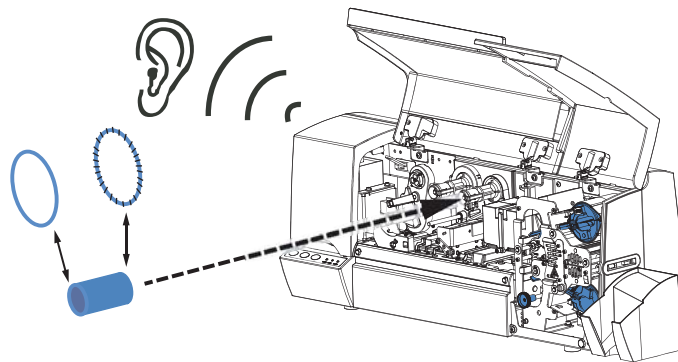

- Step 1.** Attach the Ribbon Take-Up Spool by sliding it onto the Ribbon Take-Up Spindle and pressing it straight back until it clicks into place.



---

**Important** • Make sure that the Ribbon Take-Up Spool is attached with its “toothed” end toward the rear of the printer.

---

## Connecting Power

The AC Power is connected and turned on so that in the next procedure, *Ribbon Installation*, when the printer's main cover is opened the Print Head will raise automatically.

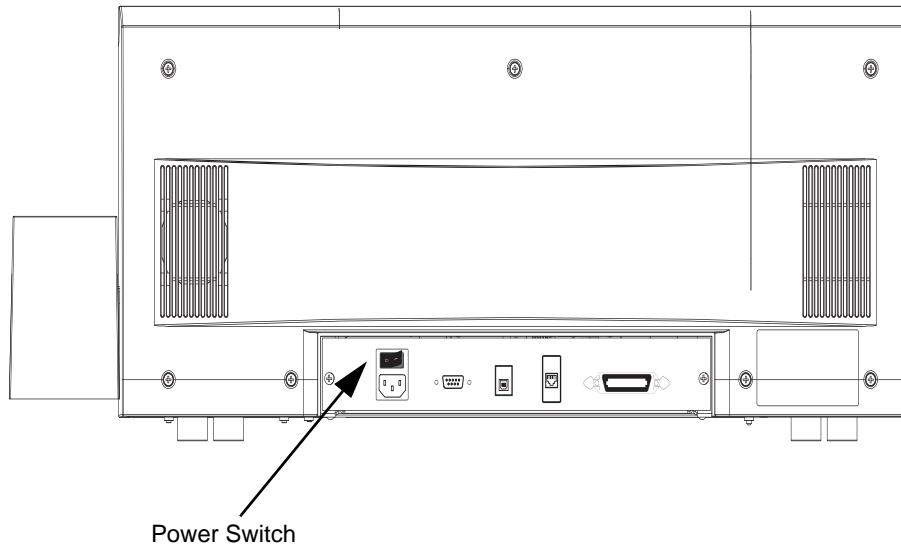

- Step 1.** Verify that the printer's Power Switch is set to OFF (O).
- Step 2.** Select the proper power cord for the local ac power source from the accessories that are shipped with the printer.



---

**Caution** • If you do not have the proper power cord for your local power source, or if the power cord appears frayed or damaged in any way, or if the power cord will not securely plug into the printer's power connection or the source outlet, **STOP!** Use of a damaged or incorrect power cord could cause equipment damage, result in an electrical fire, or possibly cause injury.

---

- Step 3.** Plug the power cord into the printer's power connection and a grounded AC power source connection.
- Step 4.** Turn the printer on by setting the Power Switch to ON (I).

## Ribbon Installation



**Note** • In normal printer operation, when the ribbon is exhausted, a warning message appears on the monitor and the MEDIA indicator on the printer lights.



**Step 1.** Open the printer Main Cover. The printhead will raise for easy ribbon loading.

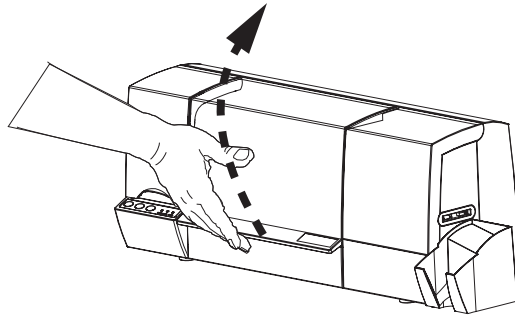

**Step 2.** Remove the ribbon from its packaging. Remove the tape that holds the end of the ribbon (save this tape; it will be used shortly).

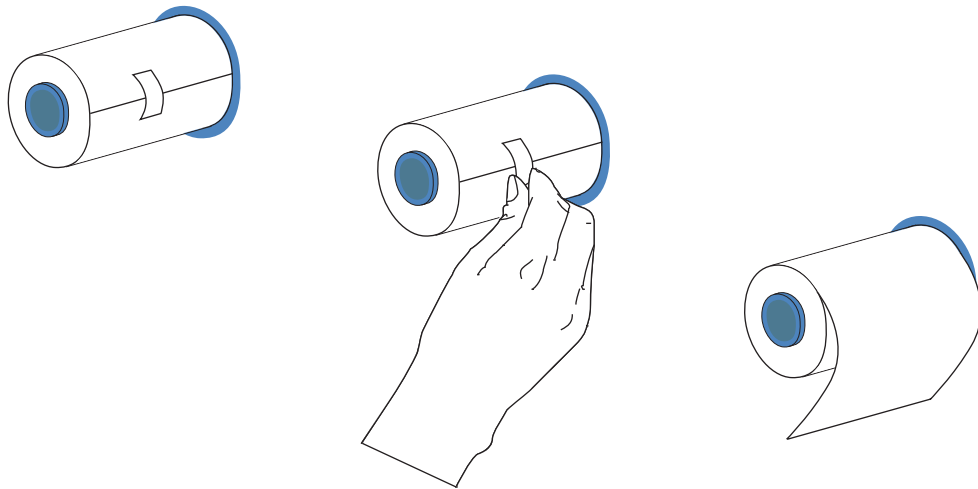

**Step 3.** Install the Ribbon on the left (supply) spindle, with the free end of the ribbon coming from the roll pointing down to your right. Note that the “flanged” end of the ribbon spool is toward the rear of the printer, and make sure the internal grooves on the core engage the teeth on the supply spindle.

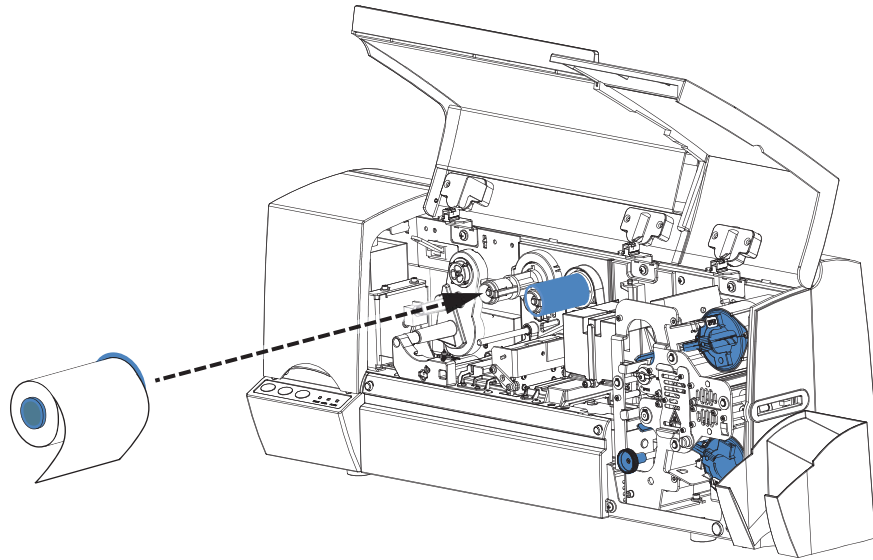

**Step 4.** Route the Ribbon as shown in the figure below. The Ribbon Supply Spindle is free-wheeling; pull ribbon off it as needed. If the tape removed from the new ribbon in step 2 is undamaged, use it to attach the end of the ribbon to the Take-Up Spool; otherwise use other adhesive-backed tape.



**Important** • When the end of the ribbon is attached to the Take-Up Spool, any slack in the ribbon can be taken up by rotating the Ribbon Supply Spool; do not try to turn the Take-Up Spool

---

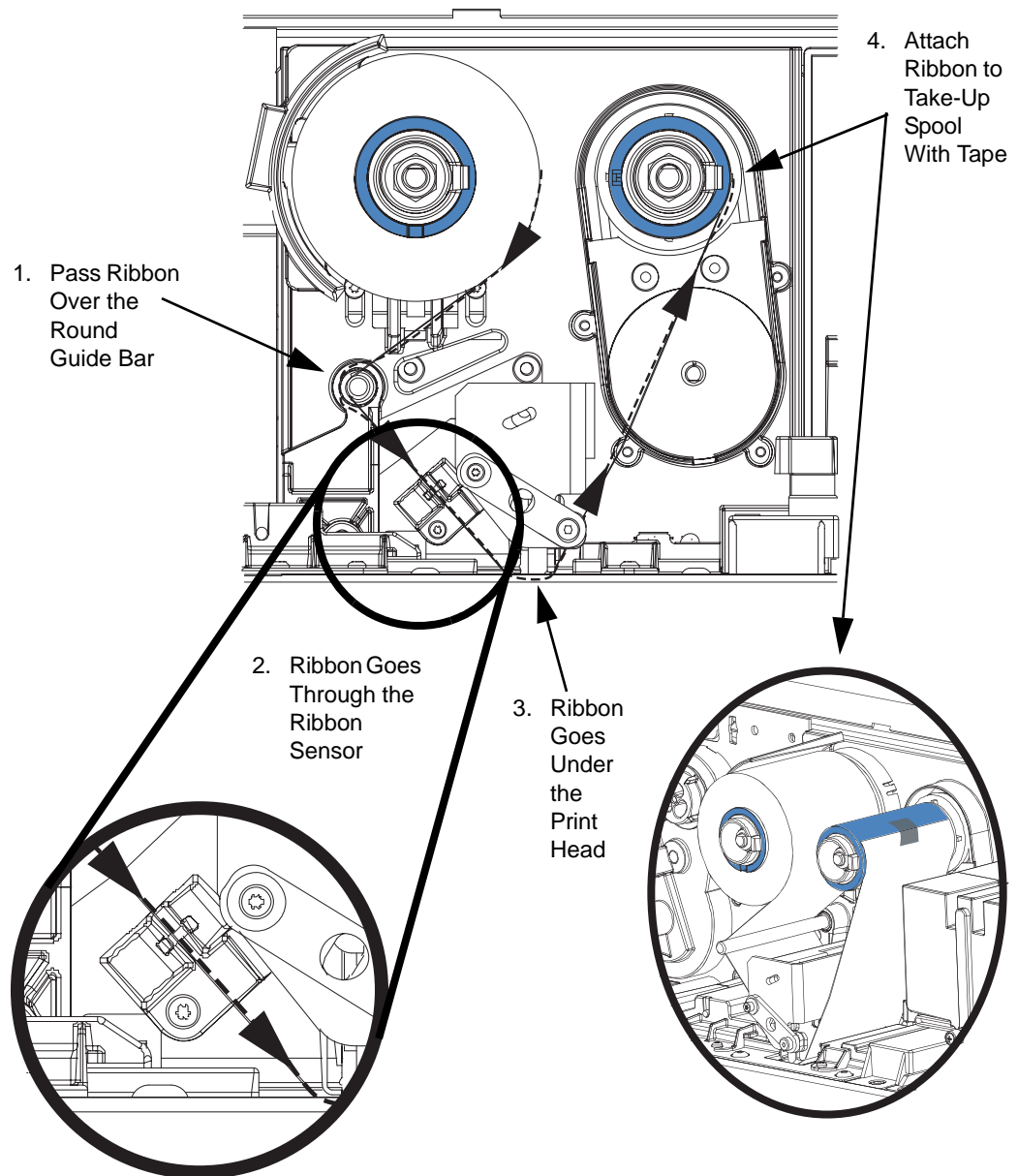

**Step 5.** Close the printer main cover, then press the RIBBON button on the Control Panel to initialize the color ribbon. If the MEDIA light fails to go out, check the ribbon sensor.



**Important** • Color ribbon wrinkling and “fold-over” can seriously affect print quality

- Step 6.** Re-open the printer cover to inspect the ribbon path for wrinkles and folds. Correct if necessary, then close the cover. If you do not then hear the ribbon motor advancing the ribbon, press the RIBBON button.

## Installing the Cleaning Cassette

Before being printed, each surface of the card is cleaned by a soft tacky roller that is itself cleaned periodically by adhesive tape in the Cleaning Cassette. Typically, the roller is cleaned every 10 cards. The printer driver software allows the card count to be modified.

By cleaning the roller every 10 cards, the Cleaning Cassette contains sufficient tape for 3,000 cards. This matches the other components of the standard Zebra media pack (3,000 cards, 3,000 color ribbon images).

- Step 1.** Open the main cover of the printer.
- Step 2.** Remove the Cleaning Cassette from its packaging.
- Step 3.** Remove the protective foil from the Cleaning Cassette. Avoid touching the exposed tacky surface.

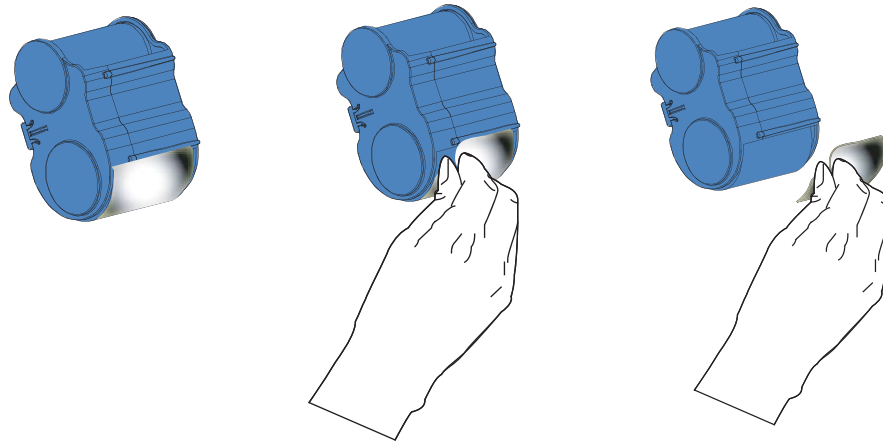

- Step 4.** Install the Cleaning Cassette on the printer by locating the rectangular pin on the cleaning mechanism in the receptacle on the cassette. Push the cassette gently home, ensuring that the internal grooves on the upper spool engage the teeth on the takeup drive; you will hear a click when it is fully engaged.

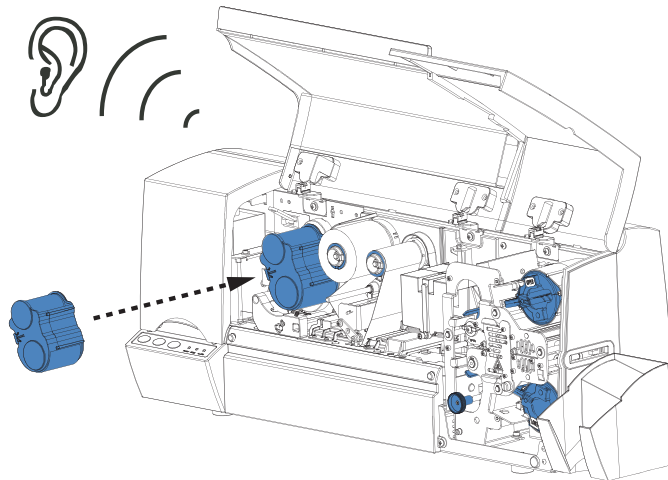

## Loading Laminate



**Note** • In this description of loading laminate, references to the lower Laminate Cassette apply only to the P640i Printer. The P640i Printer can apply laminate to both surfaces of the card; the P630i Printer only to the upper surface.

The Laminate (laminating film) is loaded into cassettes to protect it from dirt or other contaminants.

See the figure below. The “Upper Laminate Cassette”, used on both the P630i and P640i Printers, has a label with the word “UPPER” and another “label” of a **red** dot. The “Lower Laminate Cassette”, used only on the P640i Printer, has a label with the word “LOWER” and another “label” of a **yellow** dot.

“Upper  
Laminate  
Cassette”  
(P630i and  
P640i)

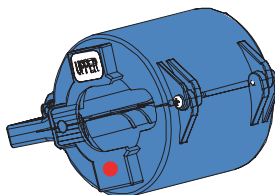

“Lower  
Laminate  
Cassette”  
(P640i only)

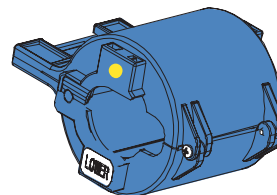

## Removing the Laminate Cassette(s)

**Step 1.** The Laminate Cassette(s) (Upper only for the P630i Printer; Upper and Lower for the P640i) are held in position by latch plates. The Upper Cassette is freed by turning its Latch Plate counter-clockwise to a full vertical position; the Lower Cassette (only present on the P640i Printer) is freed by turning its Latch Plate clockwise. Then pull the cassette straight out from its holder.

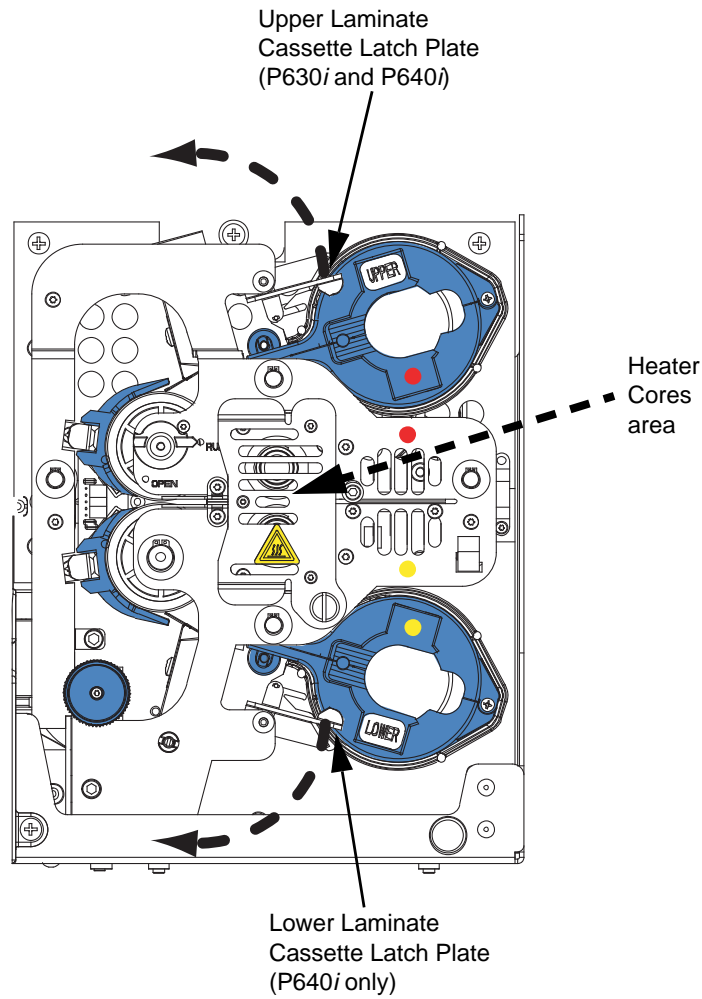

---

**Hot Surface** • If the printer has been in use, the Heater Cores area of the Laminator may be hot.

---



---

**Important** • If either Latch Plate is opened, even unintentionally, the corresponding Cassette must be removed and the Laminate reeled in.

---



**Caution** • If you feel resistance when removing the cassette, the laminate has likely run out, leaving one end attached to the core and the other end under the cutter. Keep tugging on the cassette, which will come free with a short tail of laminate.

**Step 2.** Temporarily remove the corresponding Transfer Guide to be sure there are no scraps of laminate remaining. If there are any, remove them. Then slide the Transfer Guide back in until it is held in place by the Retaining Clip.

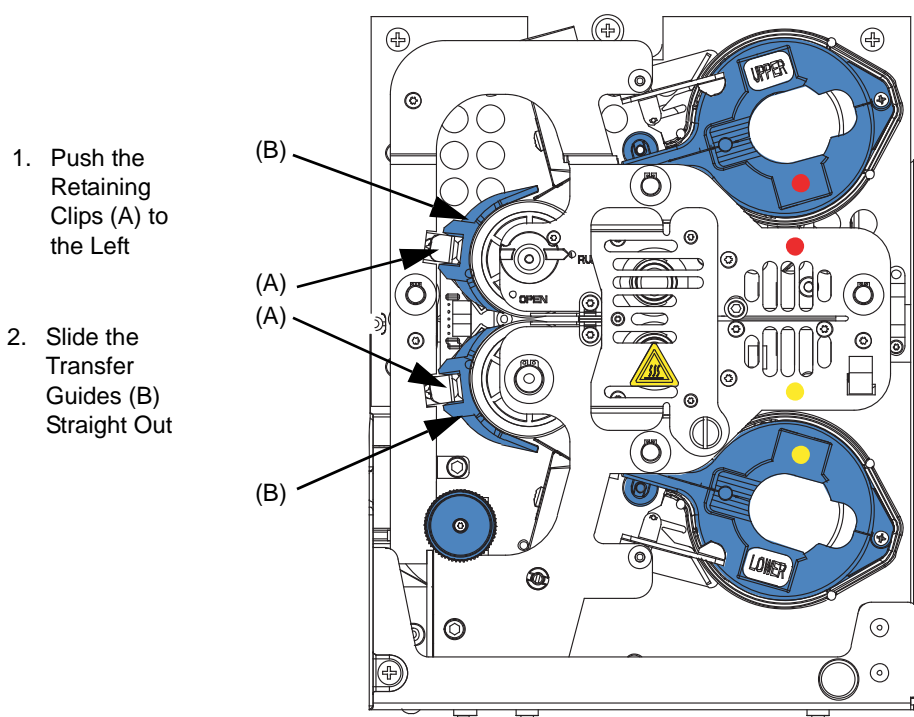

**Step 3.** Open the Cassette, like a clam shell, by separating its two halves. Grasp the two halves firmly with your fingers, then pull it apart. **Do NOT use tools.** (Upper Cassette shown.)

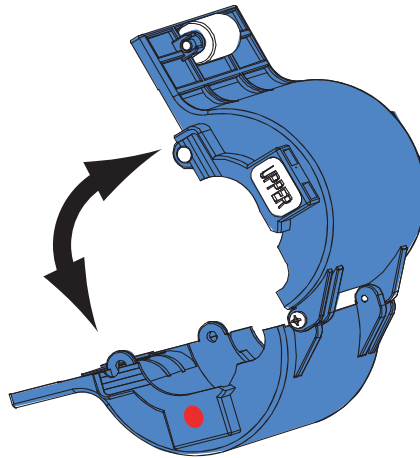

**Step 4.** If there is an empty laminate core in the Cassette, remove it.

## Loading the Laminate Cassette(s)



---

**Important** • If you are using partial-width laminate in the Lower Cassette of a P640i Printer, read the following section, *Using Partial-Width Laminate*, before proceeding with this procedure. (Partial-width laminates are frequently used on the bottom surface of cards that have a signature panel or a magnetic stripe.)

---



---

**Important** • The Upper and Lower Laminate Cassettes (the lower one only used on the P640i Printer; the upper one used on both printers) are loaded differently, even though the Cassettes appear virtually the same.

---



**Note** • Handle the laminate by the ends of the spools only to avoid contaminating the laminate.

**Step 1.** Remove the new roll of laminate from its packaging.

**Step 2.** Carefully following the guidelines in the following figure, place the laminate in the Cassette.



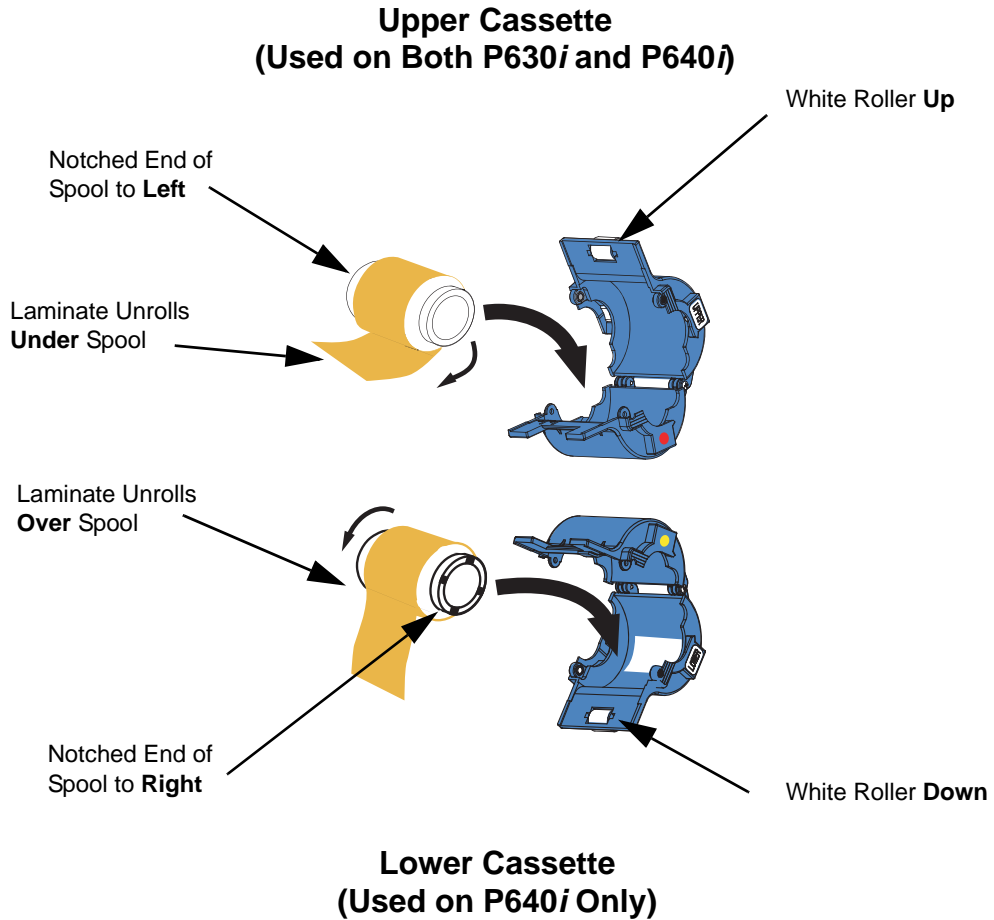

- Step 3.** Pull out an inch or two of laminate past the lip of the cassette.
- Step 4.** Close the cassette by firmly pressing the “clamshell” together. You will hear a click and feel a detent when the halves of the cassette seat together.
- Step 5.** Pull out a little more laminate between the lips of the cassette. If it suddenly stops, resisting further pulling, a spring detent on the cassette has probably snagged a notch on the end of the core. This means that the core was installed the wrong way. Open the cassette and re-install the laminate.
- Step 6.** If the exposed end of the laminate is uneven or crinkled, cut it as square as you can with scissors.

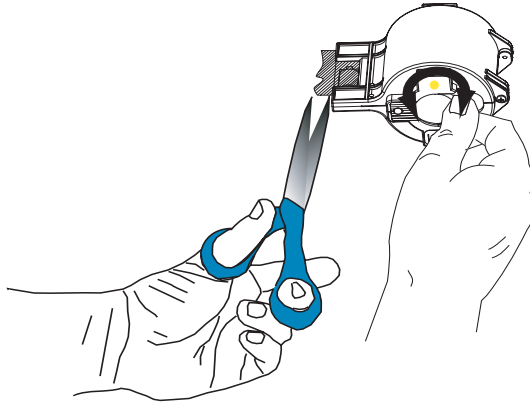

**Step 7.** Holding the cassette with the white roller up and pointing to your left, rotate the core counter-clockwise to reel in the laminate. Stop when the end of the laminate is even with the edge of the lips of the cassette.



---

**Important** • Check for overhang any time the cassette latch is opened or the cassette is removed.

---

## Using Partial-Width Laminate



**Note** • Since partial-width laminates are only used for the back (i.e., lower) surface of the card, this section only applies to the P640i Printer.

Laminates come in three widths:

“Full-Width” laminate is 2 in (51 mm) wide. Full-width laminate is used on the front (i.e., upper) or back (i.e., lower) surface of the card.

“Partial-Width” laminate is available in two widths:

- 1.66 in (42mm) wide laminate is used for cards with a writable signature panel.
- 1.33 in (33 mm) wide laminate is used for cards with a magnetic stripe

If there is no signature panel or magnetic stripe on the back of the card, full-width laminate would generally be used.

These are shown in the following figure.



**Step 1.** Remove the Laminate Edge Guide from its “storage location” on the Laminator Frame (it snaps out).

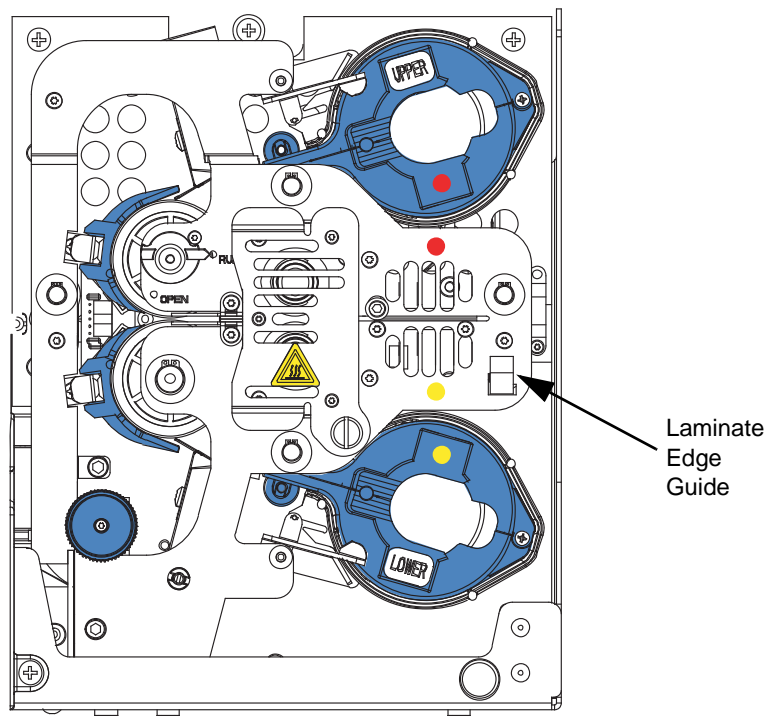

**Step 2.** For 1.3 in (33 mm) laminate for use with magnetic stripe cards, snap the Laminate Edge Guide into the inner hole-and-slot in the lower cassette, as shown in the following pictures. For 1.66 in (42 mm) laminate for use with signature-stripe cards, use the outer hole-and-slot.

**Installation**  
Installation Procedure

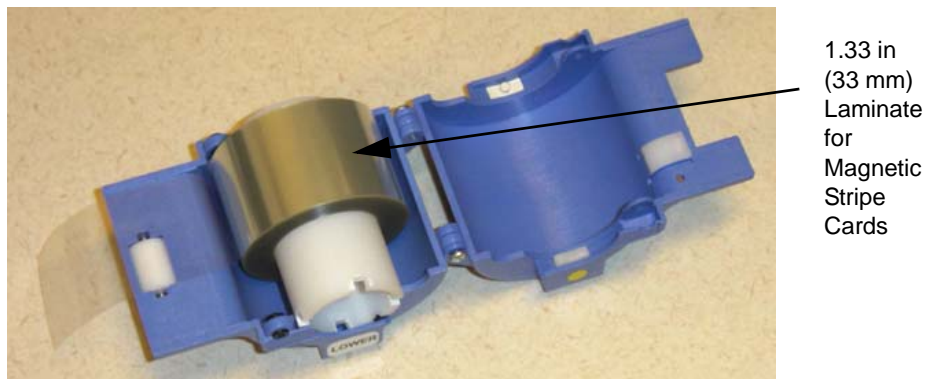
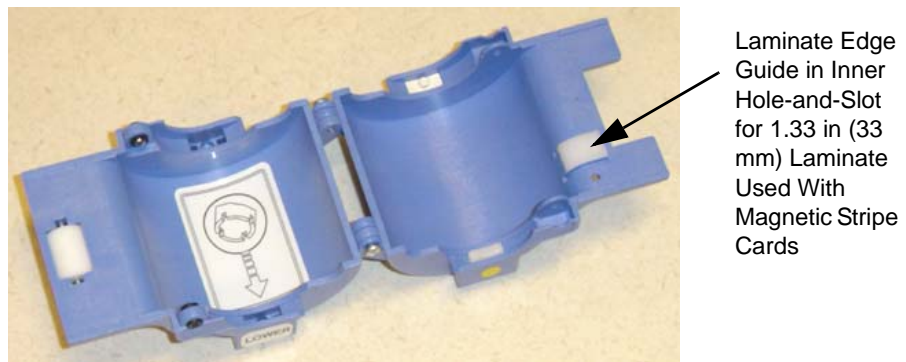

## Installing the Laminator Cassette(s)

- Step 1.** Insert the cassette into its black molded pocket, then close the cassette latch (clockwise for the UPPER, counterclockwise for the LOWER).

- Step 2.** Close the main cover. If there was a laminate error before you replaced the cassette, laminate will automatically feed from the just-loaded cassette, followed by a cutting action to free a “patch” of laminate onto the transfer roller. If laminate does not feed automatically, press the LAMINATE button on the printer control panel.

## Clearing the Laminate Channels

If your scissor cuts were neat enough to pass for machine-made cuts, continue with printing cards. If not, don't waste a print cycle. Instead, remove the hand-cut patch(es) from the Transfer Roller(s) as follows.



**Note** • Clearing procedures for the upper and lower laminate channels are similar. The upper channel is shown here.

Removal of the Transfer Guide gives access to the Transfer Roller

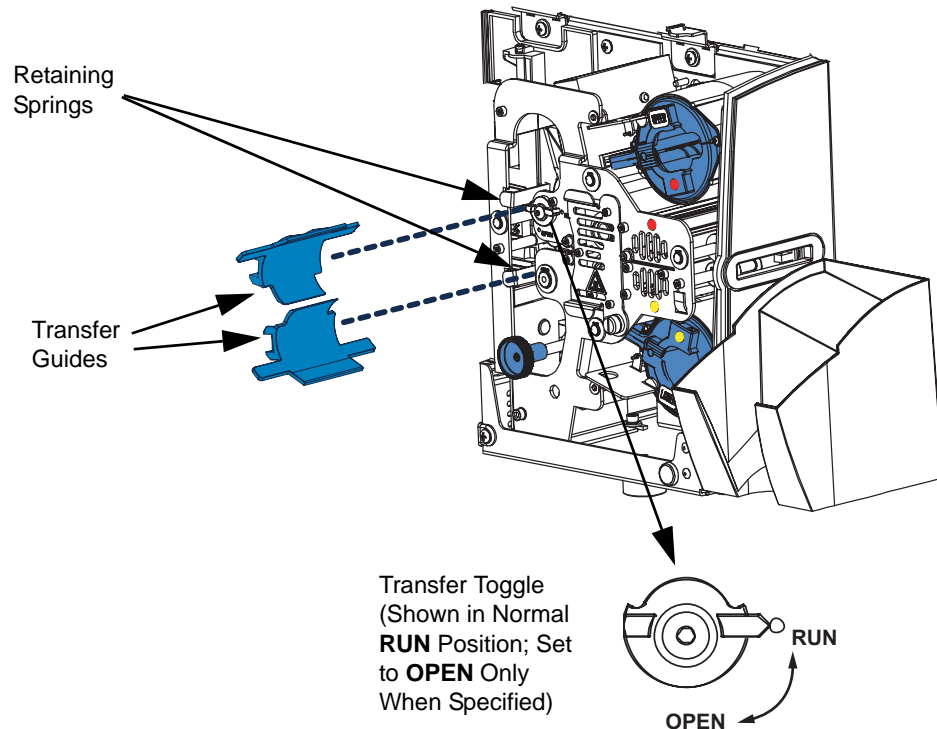

- Step 1.** Push the Retaining Spring to the left; pull the Transfer Guide straight out toward you.
- Step 2.** Remove and discard the laminate patch on the Transfer Roller. Never re-use!
- Step 3.** Turn the Transfer Toggle to the OPEN position.
- Step 4.** Remove any laminate between the Transfer Rollers.
- Step 5.** Return the Transfer Toggle to the RUN position.

**Step 6.** Re-install the Transfer Guide with its top edge above the laminate cutter guide. Pull back the retaining spring while re-inserting the guide, then release the spring as you push the guide into position. Press the LAMINATE button to load the Transfer Roller(s).



---

**Important** • Improper replacement of the Transfer Guide can cause laminate skewing and misfeeding. Be sure the Transfer Toggle is set to RUN. Take care to avoid damaging the Transfer Roller ribs when replacing the Transfer Guide.

---

## Loading Cards

The P630i and P640i Printers use standard ISO CR-80 PVC Composite cards. Do not use cards with a paper or peel-off / adhesive backing.

- Size 54 x 86 mm (2.125 x 3.375 in)  $\pm$  10%
- Thickness .75 mm (.03 in)  $\pm$  10%, frequently referred to as “30 mil cards”.



---

**Important** • Do not bend cards or touch the print surfaces as this can reduce print quality. The surface of the cards must remain clean and dust free. Always store cards in an enclosed container. Ideally, use cards as soon as possible.

---

**Step 1.** Open the Card Feeder Cover.

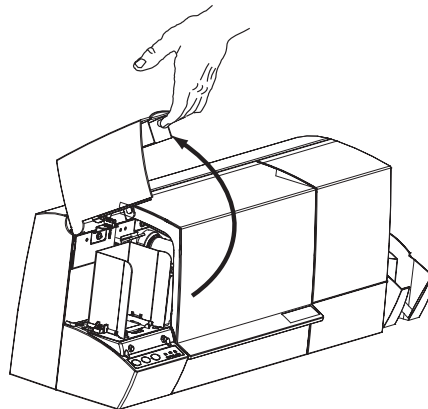

**Step 2.** Remove all wrapping from the card deck.



---

**Caution** • Do not touch print surfaces of the cards; this can reduce print quality.

---

**Step 3.** Holding the card deck by the sides, hold it vertically against a flat surface such as a desktop. If the deck is too thick for your hand to hold it comfortably, use about half a deck at a time.

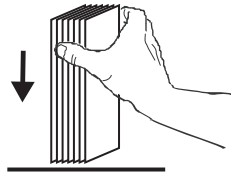

**Step 4.** Push the stack back and forth to an angle of about 45° from vertical, so as to separate all of the cards.

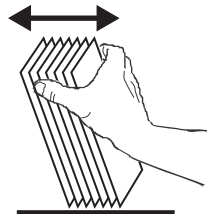

---

**Important** • Static charges and edge burrs from the card die-cutting process can render individual cards stuck together with significant adhesion force. These cards must be physically separated from each other before inserting into the Card Feeder; if not separated, feeding or printing problems may occur.

---

**Step 5.** Restore the card stack to its original squared-off condition, and place the cards in the input hopper. The input hopper can hold up to 150 cards.



**Note** • Cards with a Magnetic Stripe should be loaded with the stripe up and toward the front of the printer, as shown in the figure below.

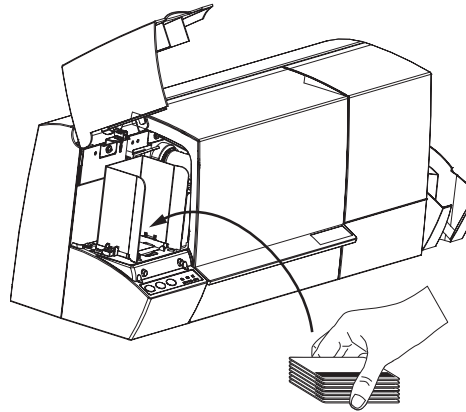

**Step 6.** Place the Card Weight on top of the card stack.

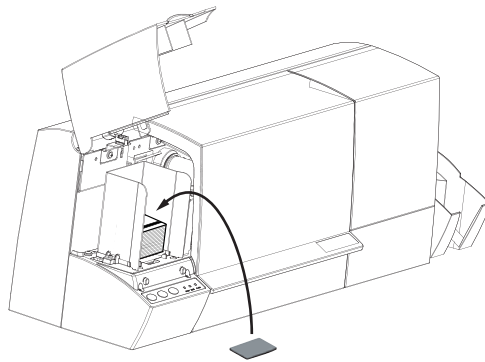

**Step 7.** Close the Card Feeder Cover.

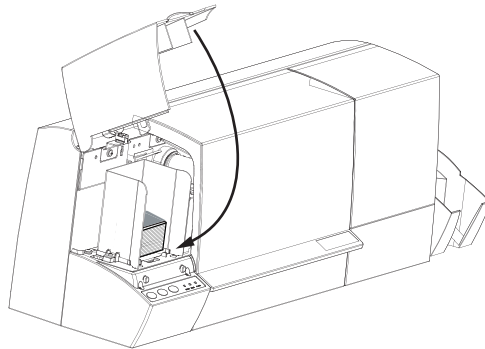



## Connecting the Interface

The P630*i* and P640*i* Printers have a USB interface as standard. As options (must be specified at time of order), the printer can additionally have a 10/100T Ethernet port for connection to an Ethernet Network, or a parallel (“Centronics”) port. Normally only one interface at a time will be connected.

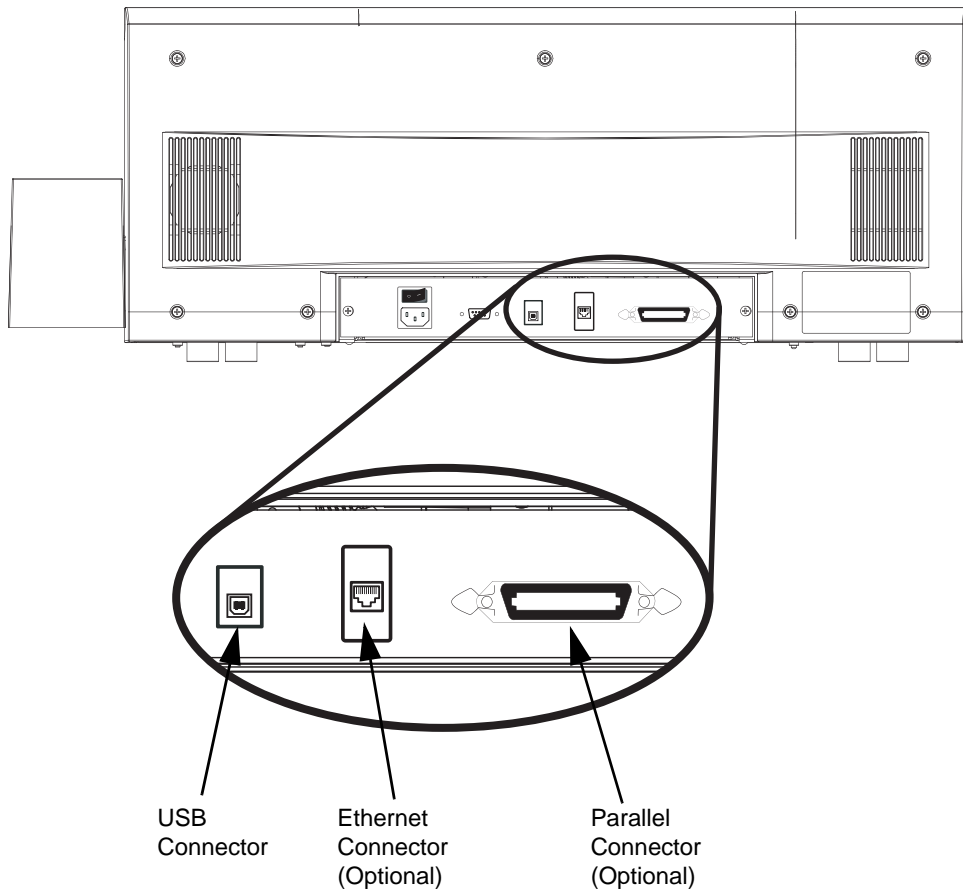





---

# Printer Driver Installation

## Overview

Each computer that will use the P630*i* or P640*i* Printer must have the Printer Driver installed. A common Printer Driver serves both P630*i* and P640*i* Printers.

To install the Printer Driver, insert the **User Documentation, Drivers, and Training CD**, included with your printer, into the host computer and the InstallShield Wizard will walk you through the required installation steps. The InstallShield Wizard will:

- Automatically install the User Interface when the driver CD is inserted.
- Start the installation process when the **Install Printer Driver** menu item is selected from the Main Menu.
- Allow you to install either a local printer and driver or a networked printer and driver.
- Detect previous versions of the driver and clean up any unnecessary Windows registry entries. You must select **Uninstall Printers and Drivers** in the Printer Setup window to remove any previous driver versions.
- Install the new driver files
- Reboot your computer

## Installing the Printer Driver (USB)



**Note** • To install the Ethernet driver, see the procedure starting on page 41.

- Step 1.** Connect the printer power and connect the USB port on the rear of the printer to the computer's USB port. Turn the Printer on and let it initialize until the READY LED on the front panel is lit.
- Step 2.** The Windows "Found New Hardware" screen will appear at this time. Click "Cancel".
- Step 3.** Insert the **User Documentation, Drivers, and Training CD** into the CD drive of the host computer. The **Select Language** window will open.



- Step 4.** From the **Select Language** window, choose the appropriate language for your system. The **Main Menu** will open in the selected language (English shown below).



**Step 5.** From the **Main Menu**, click **Install Printer Driver**. The **Printer Setup** window will open.

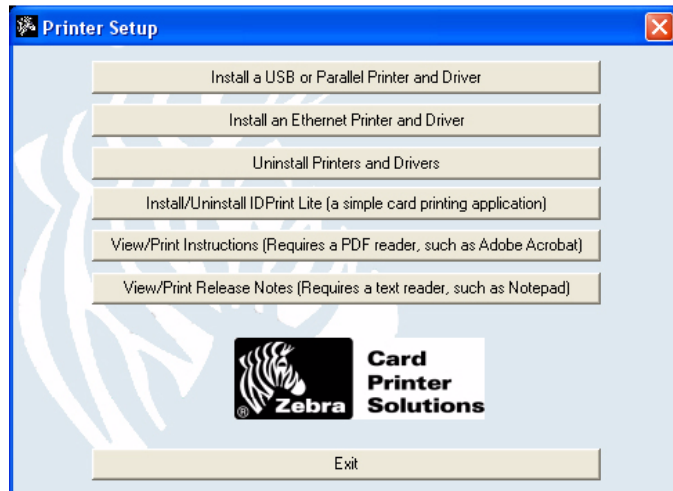

## Printer Driver Installation

### Installing the Printer Driver (USB)

- Step 6.** If an older P630*i* or P640*i* Printer and Driver is installed on your computer, click on **Uninstall Printers and Drivers** to remove it. Follow the screen prompts. At the end of the uninstall process you will be asked to re-boot your computer. Before re-booting, exit from the Driver Installation program and remove the CD. Then re-boot your computer and start over with Step 1. If the computer enters the Found New Hardware Wizard at this time, cancel this wizard.

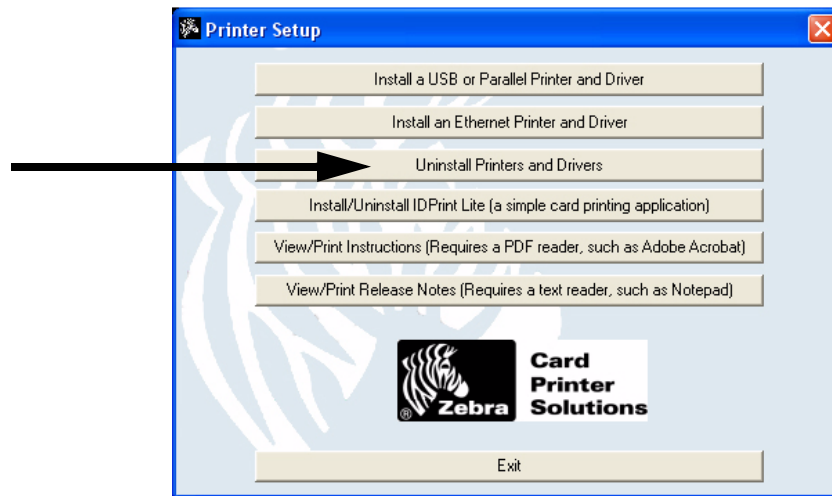

Click on **Install a USB or Parallel Printer and Driver.**

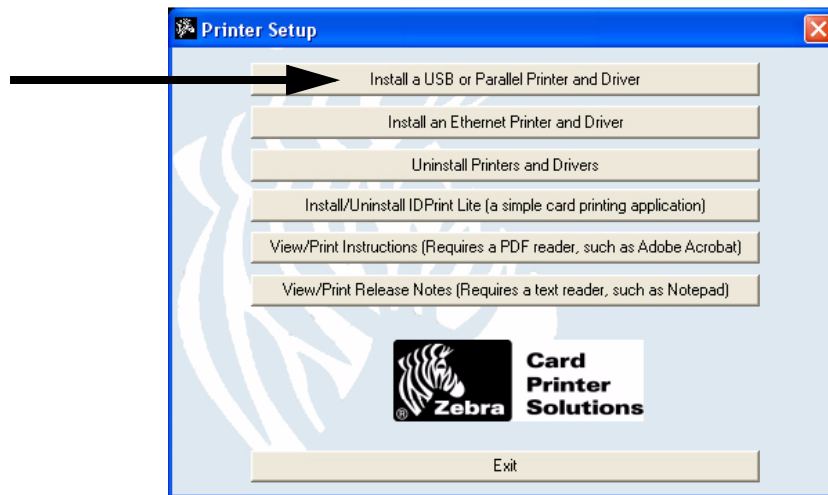

**Step 7.** This will bring up the End User License Agreement. To proceed with the installation, click **Accept**.

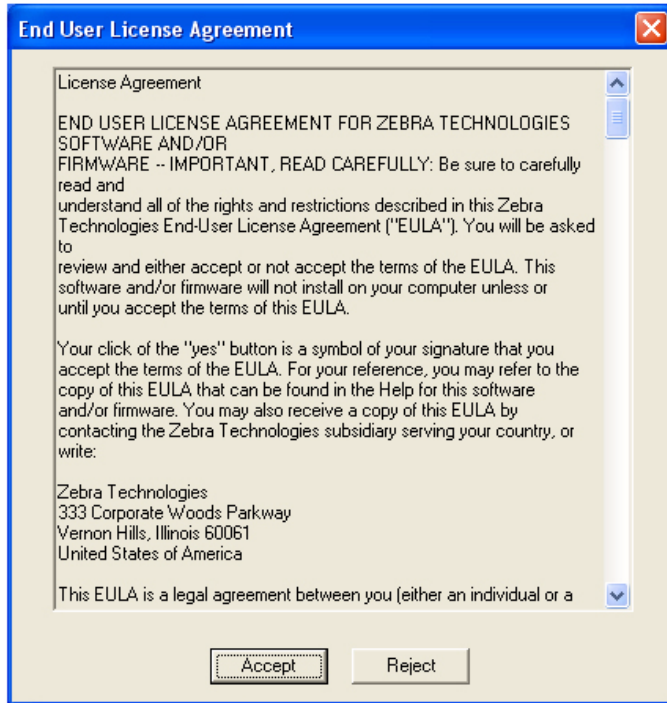

**Step 8.** This will bring up the **Add Zebra Printer Port** window. Select the **USB Port**, and then click **Next >>**.

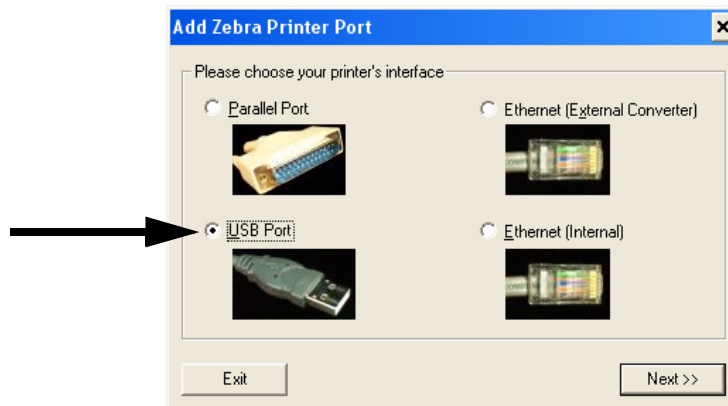

## Printer Driver Installation

### Installing the Printer Driver (USB)

**Step 9.** This brings up the Browse Printers window, shown below. If your P640i / P630i Printer is listed, select (highlight) it and click **OK**.

If your printer is not listed, make sure the printer is powered on and check the USB cable connections; then click **Rescan**. When it appears, select (highlight) it and click **OK**.

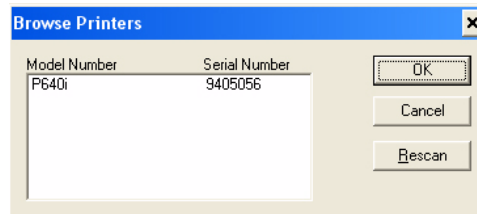

**Step 10.** This brings up the Configure USB Port window. If your printer is not listed in the Printer info area, click **Browse**.

Leave the two timeout values alone. Click **OK**.

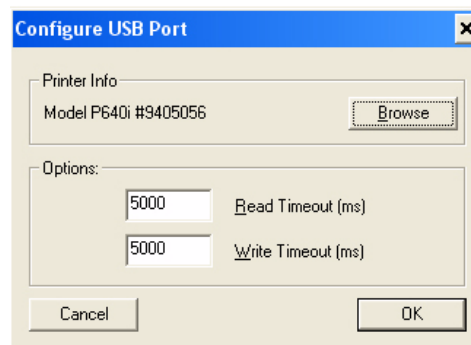

**Step 11.** This will bring up the Printer Installation window. Note the value shown on the first line (ATLUSB001 for the screen shown here), then click **OK**.

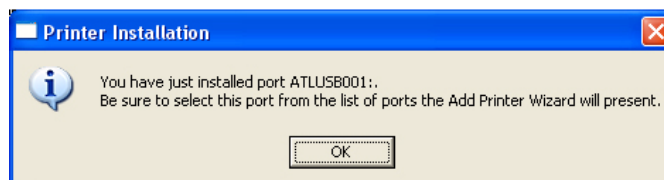



**Step 12.** This opens the Add Printer Wizard welcome window. Click **Next >**.

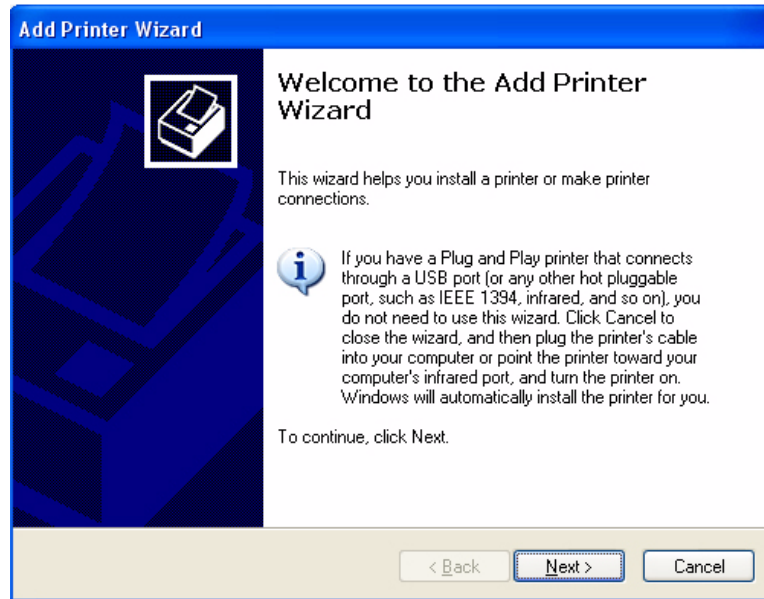

**Step 13.** This brings up the Add Printer Wizard Local or Network Printer window. For a typical USB installation, select **Local Printer attached to this computer** and check the box to detect a Plug and Play printer.

Then click **Next >**.

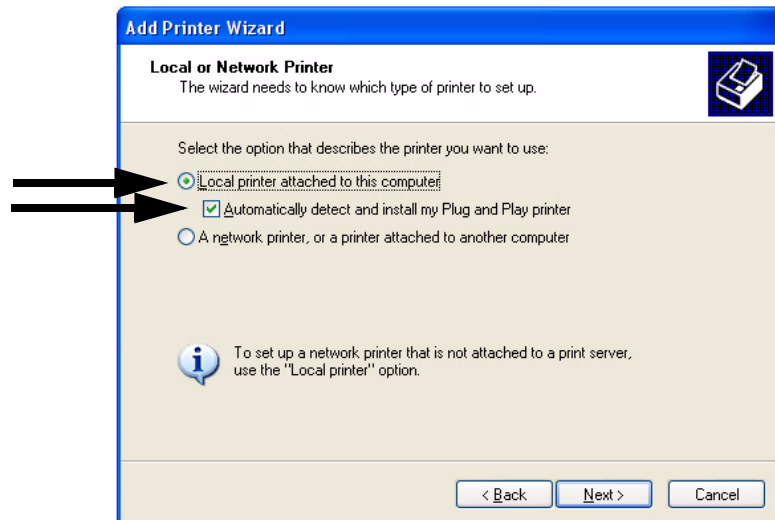

## Printer Driver Installation

### Installing the Printer Driver (USB)

**Step 14.** This brings up the Found New Hardware Wizard welcome window. In general, select **Yes, this time only** and then click **Next >**.

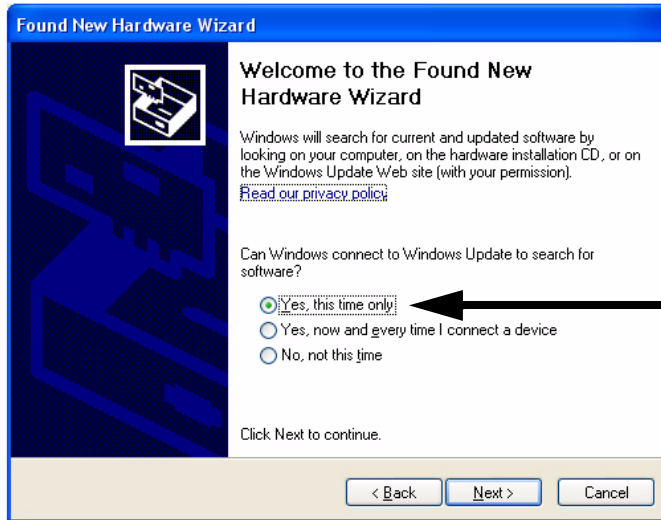

**Step 15.** The next window helps install the software driver. Select **Install the software automatically (Recommended)** and then click **Next >**.

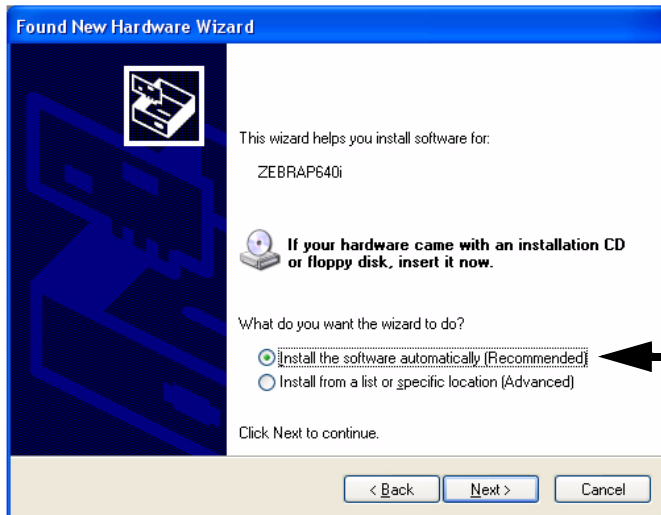

**Step 16.** The Wizard will search for the Printer. The screen that appears while searching appears on the next page.

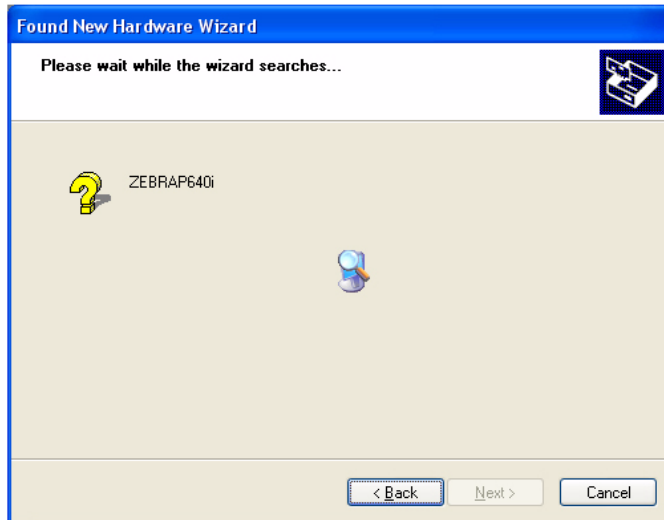

**Step 17.** When the Wizard finds the Printer, it may display a window referring to compatibility, as shown below. If so, click **Continue Anyway**.



## Printer Driver Installation

### Installing the Printer Driver (USB)

Wait while the Wizard installs the software.

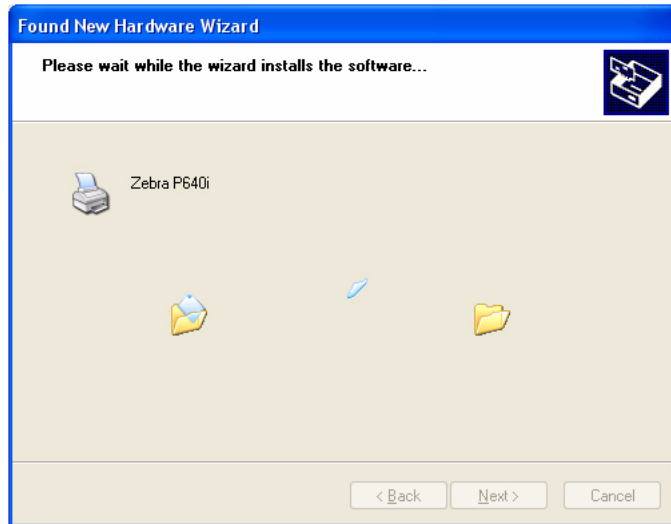

**Step 18.** When software installation is complete, the following window will display. Click **Finish**.

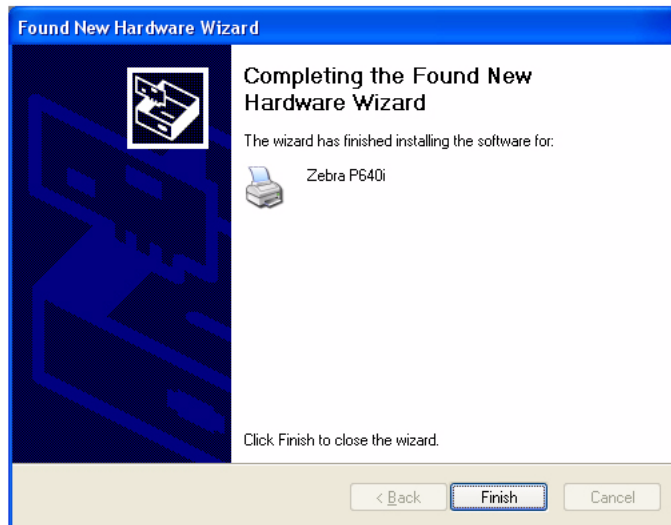

**Step 19.** This completes software driver installation. To use the P630i or P640i Printer, you would select it just like you would any other printer connected to a Windows system.

## Installing the Printer Driver (Ethernet)



**Note** • To install the USB driver, see the procedure starting on page 32.



**Important** • The Ethernet Network must be configured correctly, with the Printer and the host computer on the same subnet mask. If you are not sure how to verify this or change the configuration, consult someone knowledgeable on Ethernet Networks.

- Step 1.** Connect the printer power and connect the Ethernet Port on the rear of the printer to an Ethernet Network Port. Turn the Printer on and let it initialize until the READY LED on the front panel is lit.
- Step 2.** Insert the **User Documentation, Drivers, and Training CD** into the CD drive of the host computer. The **Select Language** window will open.



- Step 3.** From the **Select Language** window, click on the appropriate language for your system. The **Main Menu** will open in the selected language (English shown below).

## Printer Driver Installation

### Installing the Printer Driver (Ethernet)



**Step 4.** From the **Main Menu**, click **Install Printer Driver**. The **Printer Setup** window will open. Click **Install an Ethernet Printer and Driver**.

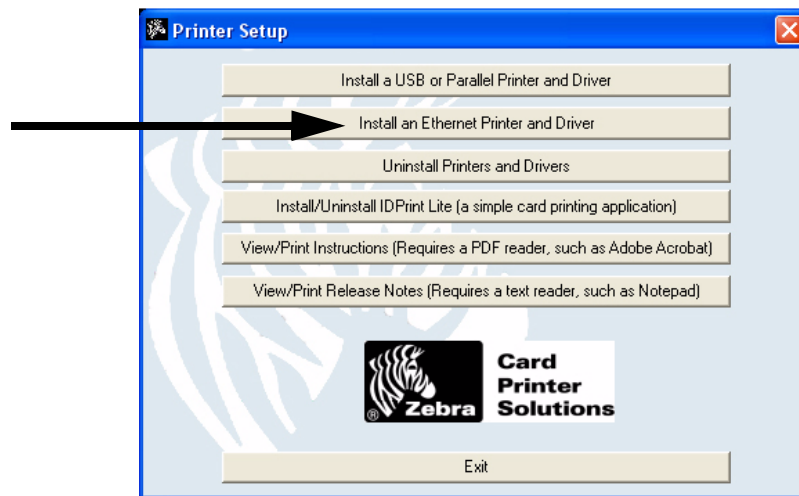

**Step 5.** This will bring up the End User License Agreement. To proceed with the installation, click **Accept**.

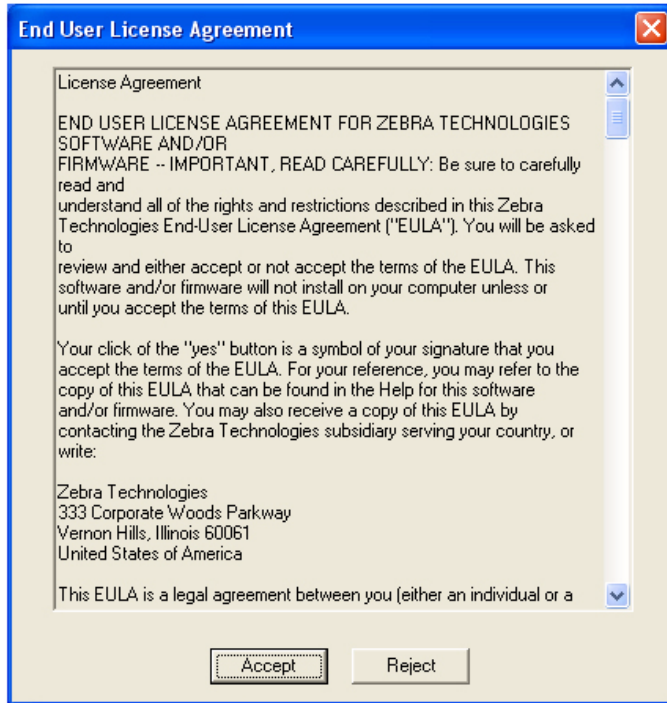

**Step 6.** This brings up the **Configure Ethernet Port** screen. Click the **Browse** button.

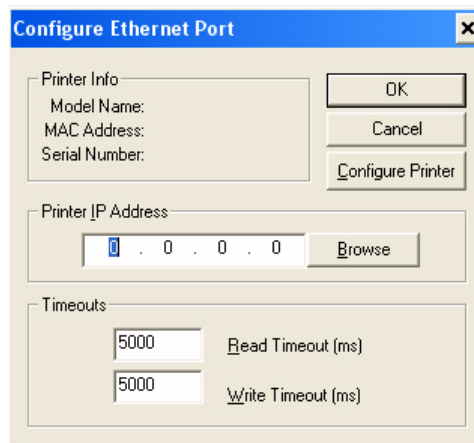

## Printer Driver Installation

### Installing the Printer Driver (Ethernet)

**Step 7.** Any Zebra printers will be located. Select (highlight) the desired printer (for this procedure it is a P640i, but the steps would be the same for a P630i) and click the **OK** button.



**Note** • If the Printer is not found, check to make sure the Printer is powered on and the Ethernet connector is engaged. Also, the Ethernet Network must be configured correctly, with the Printer and the host computer on the same subnet mask. If you are not sure how to verify this or change the configuration, consult someone knowledgeable on Ethernet Networks.

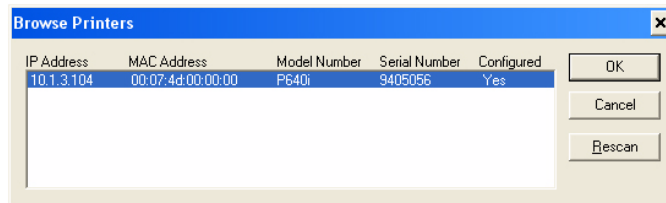

**Step 8.** The Configure Ethernet Port screen will reappear, but now the information for the P640i printer selected in step 7 will be displayed.

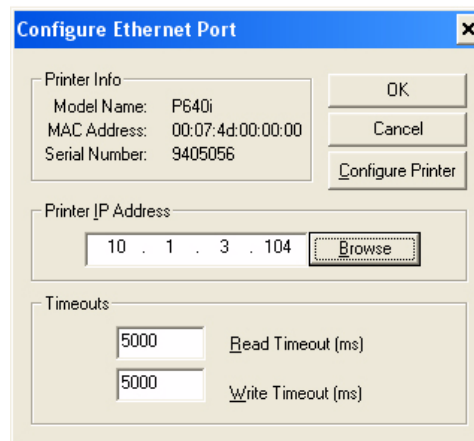

Then click **OK**.



**Step 9.** This brings up the Add Printer Wizard. Click **Next >**.

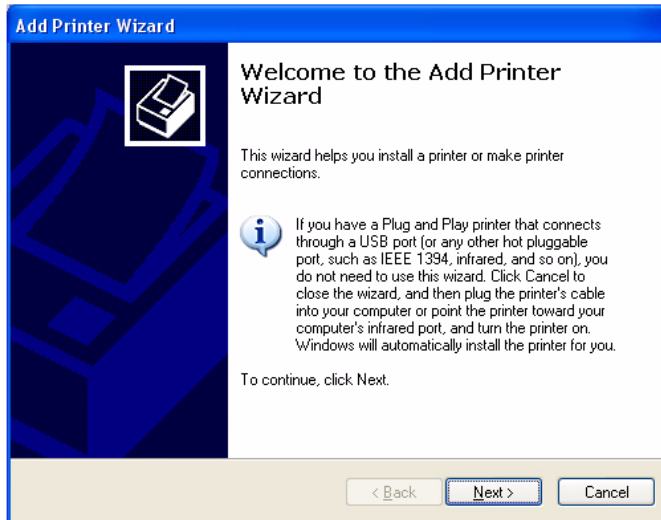

**Step 10.** The next screen lets you specify the type of printer to set up. Select “Local printer attached to the computer.”

“Automatically detect and install my Plug and Play printer” should be **un-checked**. Then click **Next >**.

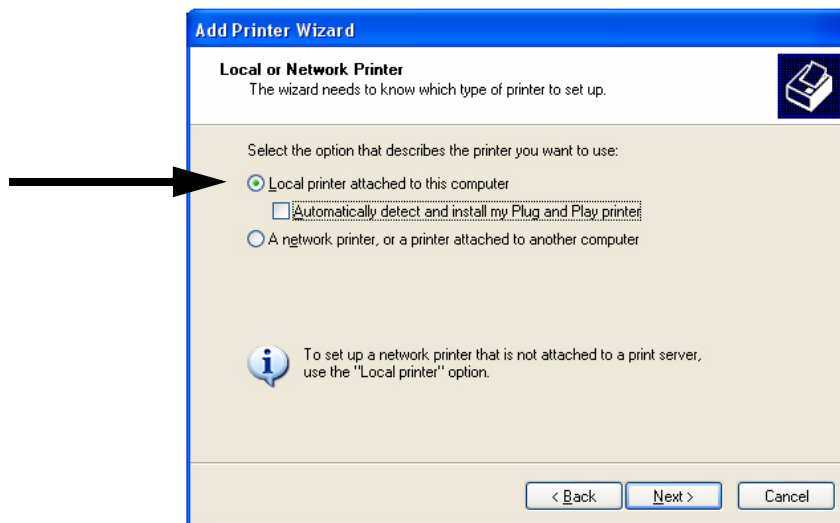

Click **Next >**.

## Printer Driver Installation

### Installing the Printer Driver (Ethernet)

**Step 11.** The Add Printer Wizard / Select a Printer Port screen will now appear.

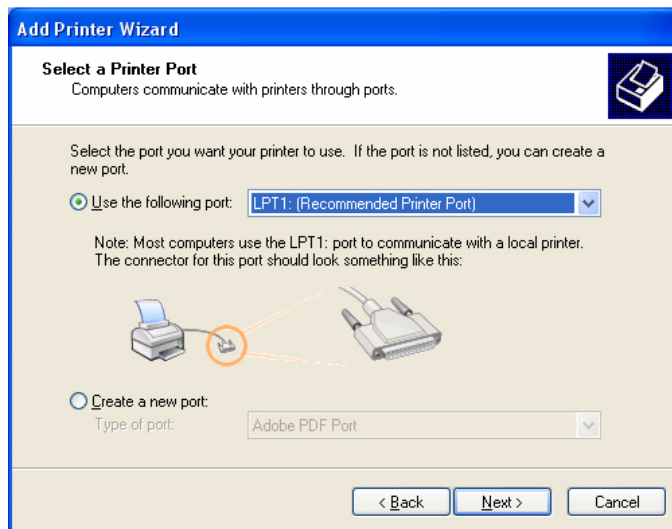

**Step 12.** Click on “Use the following port”; scroll to “ENETxxx (Zebra Ethernet (internal))” where “xxx” is the number of the port - any Zebra Ethernet port number can be used.

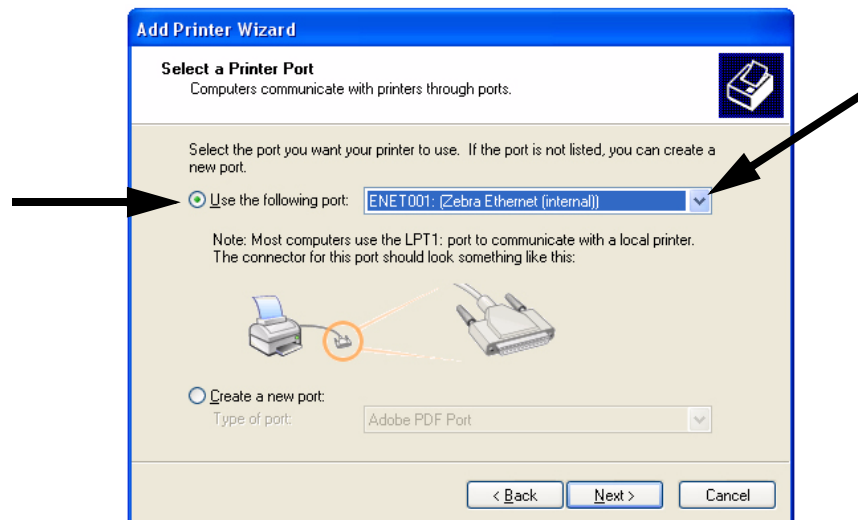

Check that the printer is turned on (and the READY LED is lit), then click **Next >**. Then click **Next >**. This will bring up the “Add Printer Software Wizard”, as shown on the next page.

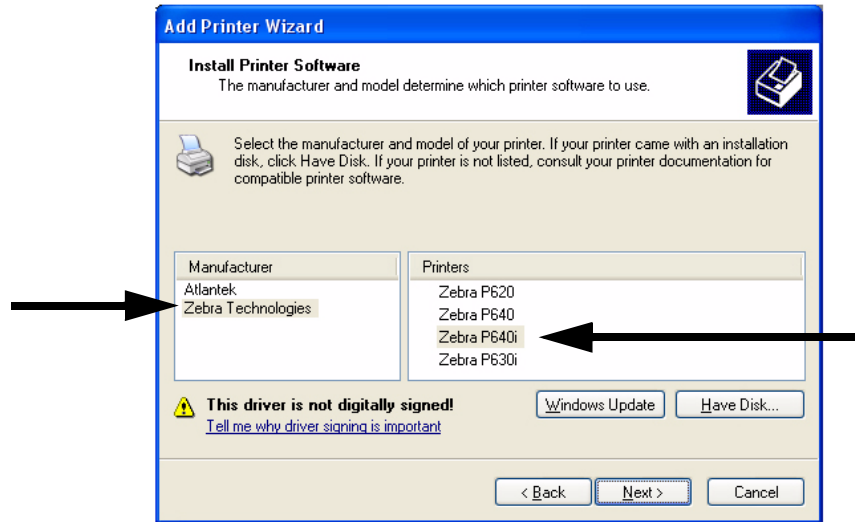

Select the Manufacturer (Zebra Technologies) and the printer model number; then click **Next >**.

**Step 13.** This brings up the “Name Your Printer” screen.

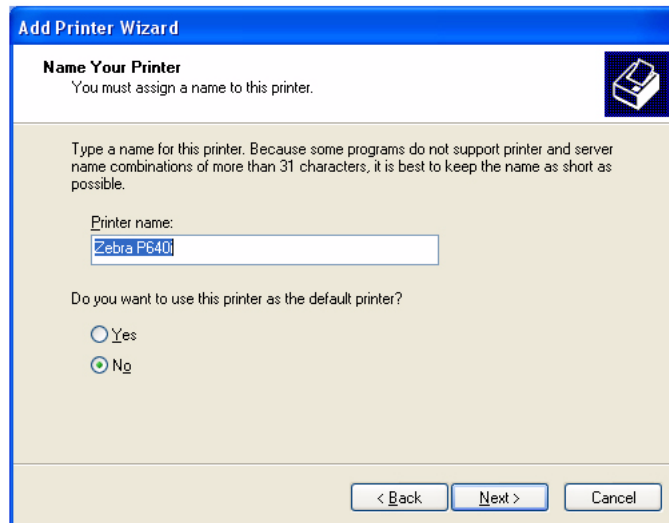

Verify that the printer name is correct. Specify if you want to use this printer as your default printer (this can always be changed in the Windows Printers or Printers and FAXes control panel).

Then click **Next >**.

## Printer Driver Installation

### Installing the Printer Driver (Ethernet)

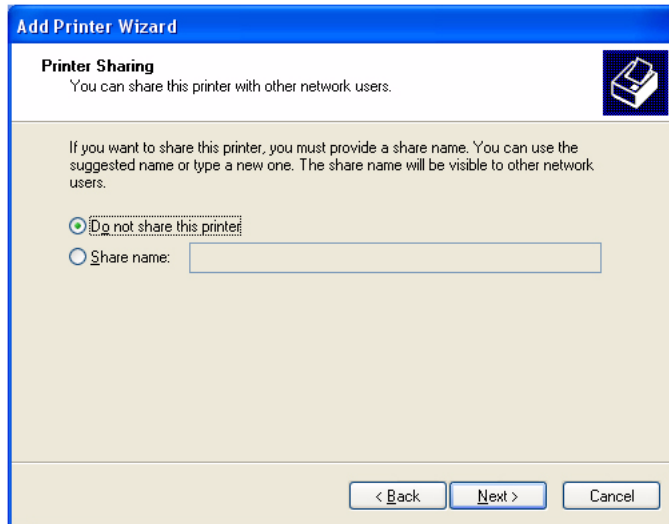

**Step 14.** Specify whether or not you want to allow printer sharing, then click **Next >**.

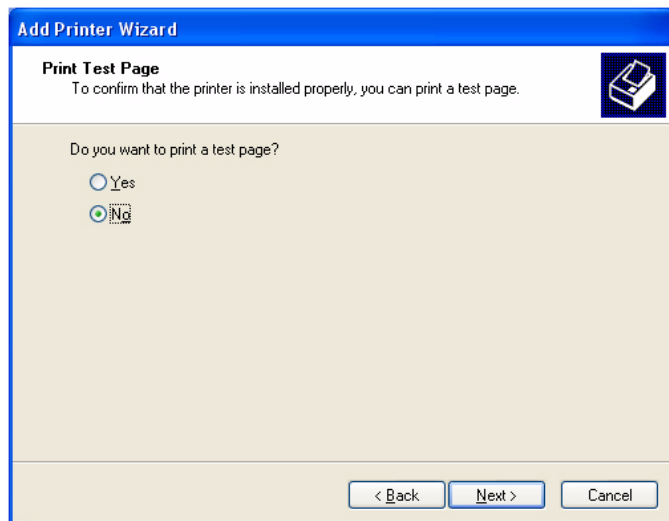

**Step 15.** Specify if you wish to print a test page (note that card printers consider each card to be a page); then click **Next >**.

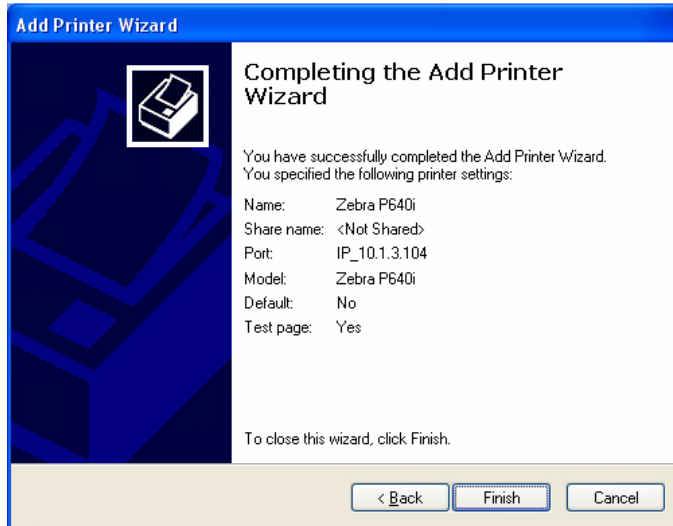

**Step 16.** Click **Finish**. The following screen will appear.

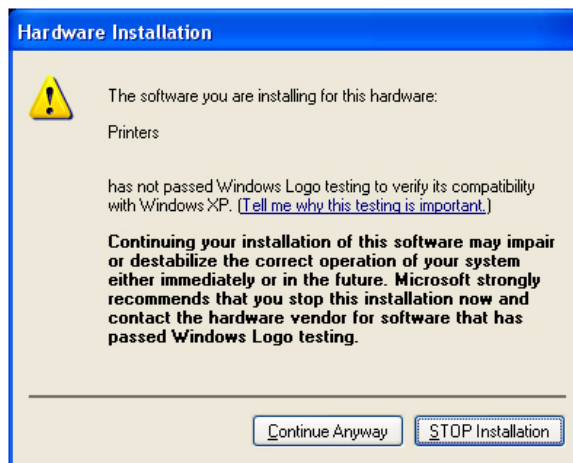

**Step 17.** Click on **Continue Anyway**. You will see files being copied to the Windows folder. When the file copying is complete, your printer is ready to use.

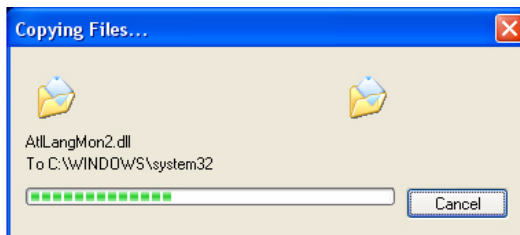



## **Printer Driver Installation**

Installing the Printer Driver (Ethernet)



---

# Settings and Adjustments

## Introduction

This section describes settings and adjustments that can be made to the P630*i* and P640*i* Printers.

## Sensors and Interlock Switches

These are of several different types of sensors and interlock switches, but they have one thing in common - they tell the printer's control logic what's happening and where, enabling it to continue with the process or, if a malfunction occurs, to light the appropriate indicator light and report a specific error condition on the host computer screen.

The sensors and interlocks are shown in the following figure.

## Settings and Adjustments

### Sensors and Interlock Switches

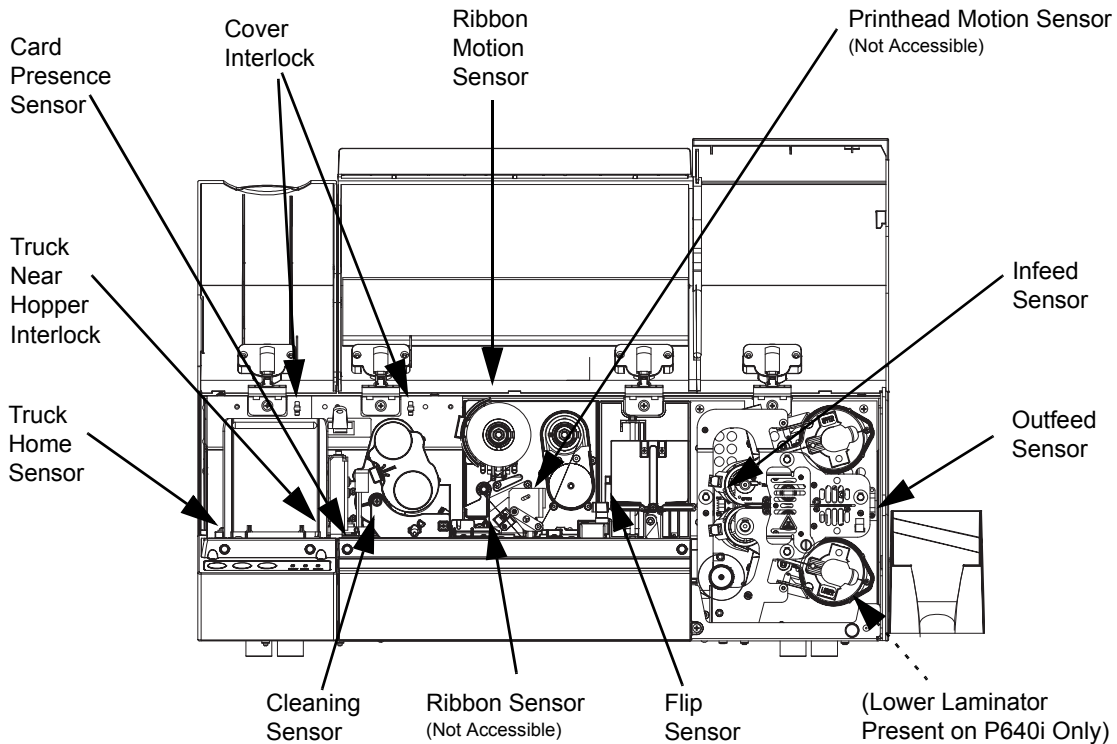

## Access Printer Sensor Data

To access the Sensor Data screen, select *Start > Printers (or Printers and Faxes)*. Right click *Zebra P630i* or *Zebra P640i*, then select *Properties > Device Settings > Control > Advanced Utilities > Show Sensor data*.

Sensor Data	
<b>Ribbon</b>	
Ribbon Panel Detect:	206
Panel Threshold:	104
Ribbon Encoder Count:	478
<b>Laminate</b>	
Top Laminate Sensor:	227
Bottom Laminate Sensor:	200
Lam. Present Threshold:	124
Lam. Absent Threshold:	140
<b>Miscellaneous</b>	
Card Presence Sensor:	245
Printhead Voltage:	23.760 V
AC Frequency:	60 Hz
Assumed AC Voltage:	110 V
<b>Temperature</b>	
Printhead Temp:	24 °C
Controller Board Temp:	29 °C
Top Heater Temp:	29 °C
Bottom Heater Temp:	29 °C
<b>Logic States</b>	
Hopper Door:	1
Main Door:	1
Truck Near Hopper:	1
Truck Home:	0
Printhead Lift:	0
Flip Station:	1
Card Lam Enter:	0
Card Lam Exit:	0
0 = unblocked/not pressed/open 1 = blocked/pressed/closed	
Close	



**Ribbon Panel Detect.** The current reading of the color ribbon sensor.

**Panel Threshold.** The current value of the detection threshold for the color ribbon. Above this value is termed “black,” below this value is termed “not black.”

**Laminate Sensors.** Reflective sensor that detect the presence of laminate on the transfer rollers: below threshold = laminate present, above threshold = laminate absent.

**Card presence Sensor.** The reflective sensor to the right of the card hopper: High = no card, Low = card present

**Printhead Voltage.** Should be about 24V.

**AC Frequency.** 50 or 60 Hz

**Assumed AC Voltage.** 110V assumed for 60 Hz.

**Printhead Temperature.** Temperature ceiling 70°C (above that temperature, printing is stopped until the head cools).

**Controller Board Temperature.** Should be about 5° above ambient.

**Heater Temperature.** Temperatures at the top and bottom laminate heater cores.

**Logic States.** Summarizes all two-state interlocks and photo sensors - a very useful diagnostic tool

## Printer Properties

To access the various Printer Properties, select *Start > Printers (or Printers and Faxes)*. Right click *Zebra P630i* or *Zebra P640i*, then select *Properties*

### General

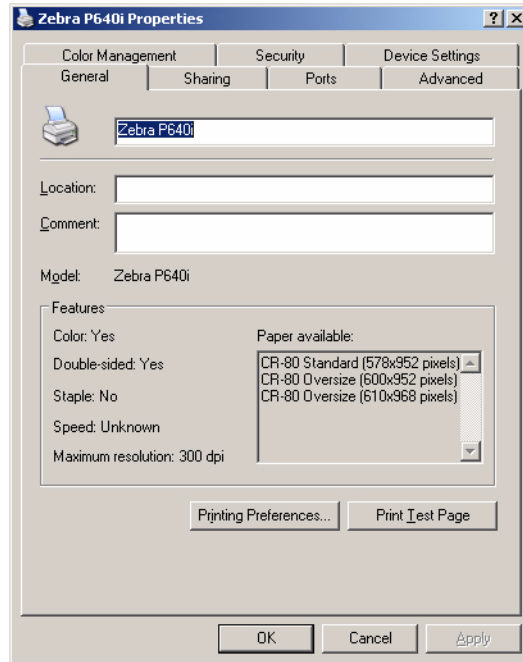

**Printing Preferences** Brings up the preferences screen. Reference **Printing Preferences** below.

**Print Test Page** Prints the standard Windows test page.

### Sharing

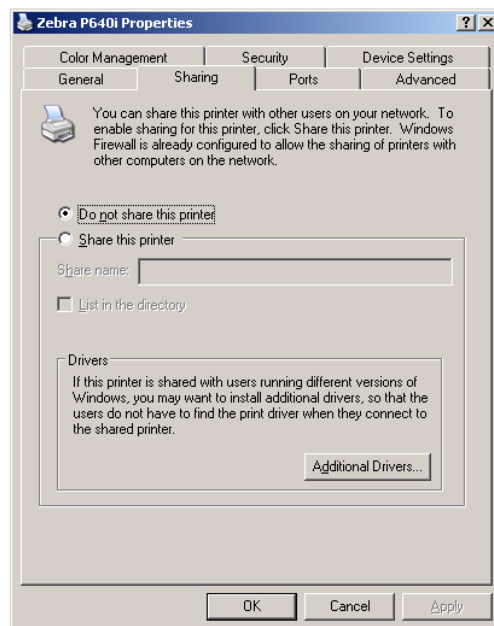

This is sharing according to the Microsoft Windows definition. In a network environment, it allows other computers to send jobs to the printer that's connected to your computer.

## Ports

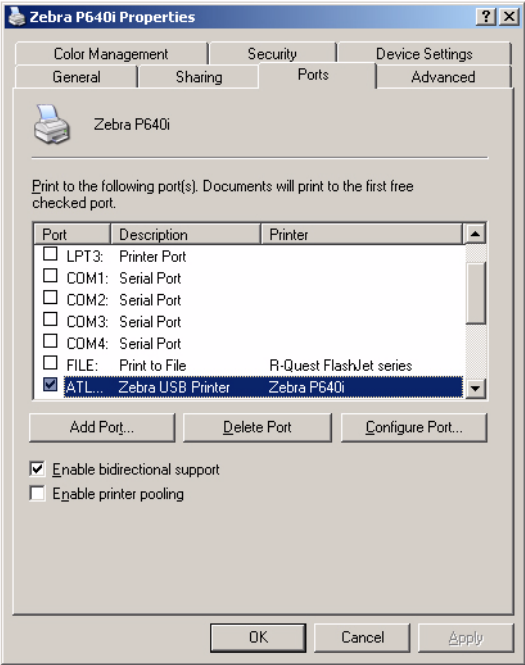

Specifies the computer port to which the P630i or P640i is connected. This will have been established at the initial installation of the printer, and will not normally require attention.

An exception to this is if you wish to use “printer pooling”, the ability to distribute print jobs to multiple printers. To enable printer pooling, check the “Enable Printer Pooling” box, then check multiple ports. Each port should have a single Zebra printer installed on it, and all printers should be configured identically (for example: all with YMC front, K back). Now, when you print to the “main printer” (that is, whichever printer you right-clicked in Printers and Faxes to get to this screen), this printer will get print jobs until it has buffered as many jobs as it can take. Remaining jobs will then “spill over” to other printers until all printers in the pool are busy.

## Advanced

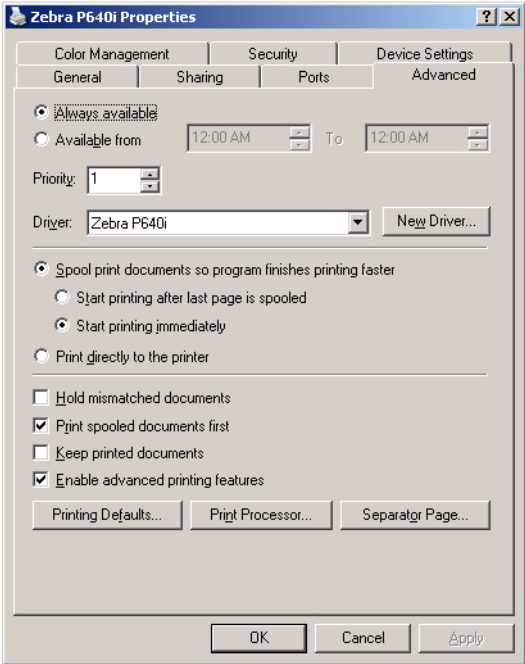

Determines the spooling (queuing) of print jobs, and how spooled jobs are handled relative to the most recent job. Printing Defaults allows the system administrator to establish default settings such as print quality.

## Color Management

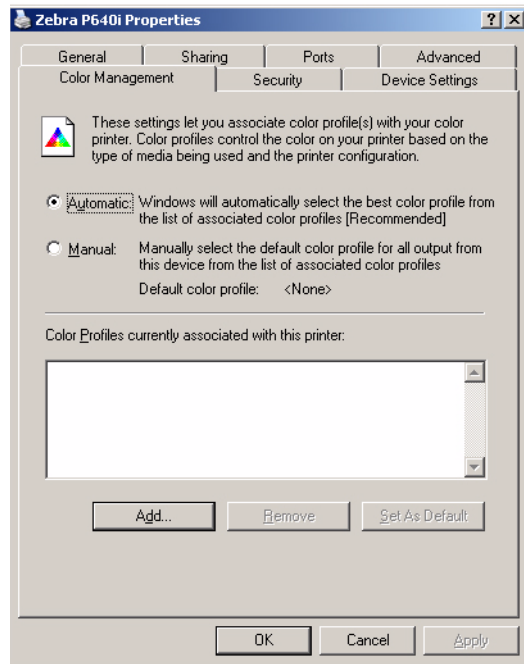

Color Management settings allow you to associate color profiles on the printer based on the type of media being used and printer configuration. The **Add** button allows the operator to add additional profiles to the color profile list.

**Automatic** Allows Windows to select the best color profile.

**Manual** Allows the operator to select the desired profile from the list shown in the Color Profile Window.

## Security

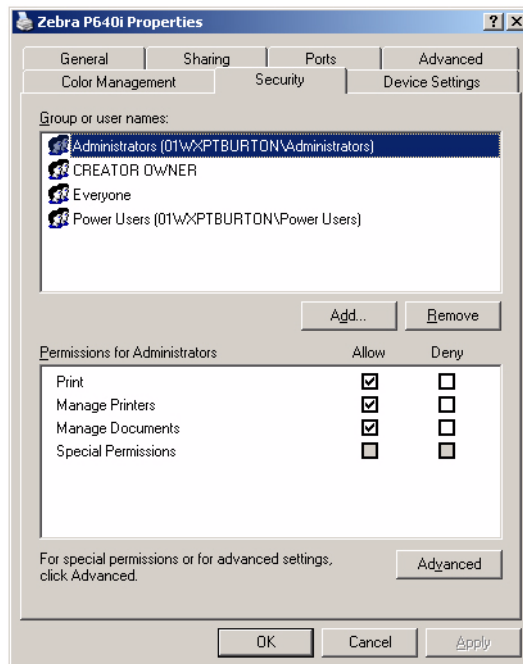

This is the standard Windows security screen, showing user access to various printer control options. Both Print and Manage Printers *must* be checked for full functionality of the printer.

# Device Settings

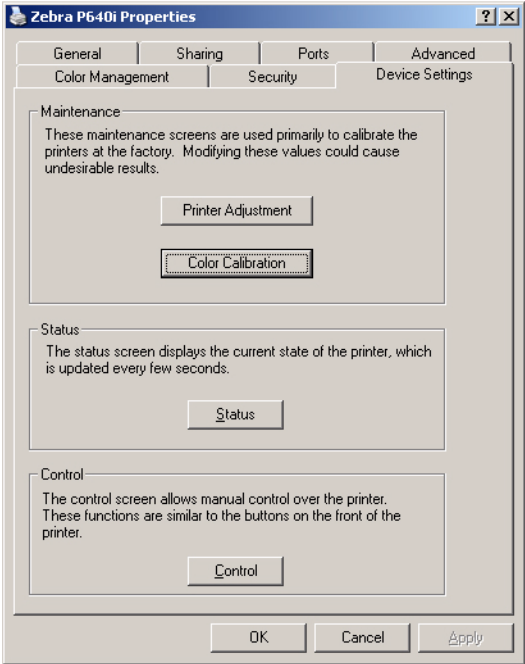

The Device Settings screen allows you to access various adjustment and calibration screens.

**Printer Adjustment** The following procedures can be performed from the Printer Adjustment screen:

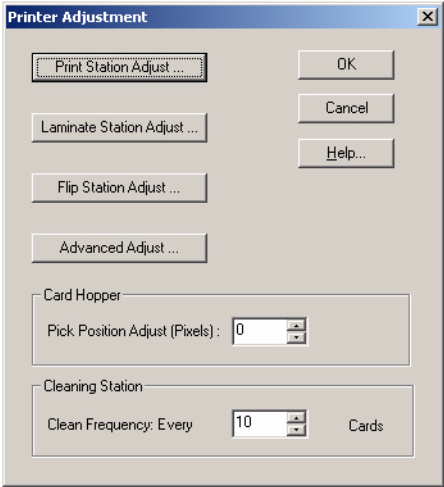

- 1. Print Station Adjustment
- 2. Laminates Station Adjustment
- 3. Flip Station adjustment
- 4. Advanced Adjustments:
  - a. Magnetic Encoder Position
  - b. Smart Card Position
- 5. Card Hopper Pick Position
- 6. Cleaning Frequency

**Color Calibration** The following procedures can be performed from the Color Calibration screen:

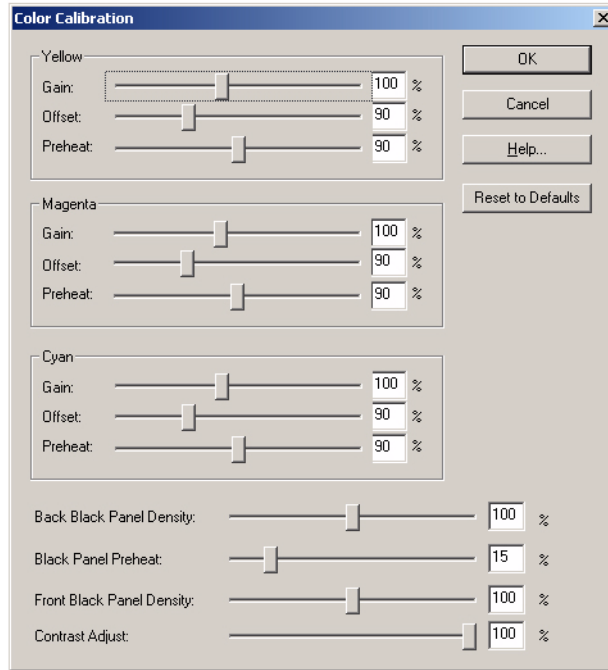

1. Yellow
  - a. Gain
  - b. Offset
  - c. Preheat
2. Magenta
  - a. Gain
  - b. Offset
  - c. Preheat
3. Cyan
  - a. Gain
  - b. Offset
  - c. Preheat
4. Black Panel Density
5. Black Panel Preheat
6. Contrast Adjustment
- 7.
- 8.

**Status** The Status screen displays the current state of the printer and provides standard printer information and sensor data, which is updated every few seconds

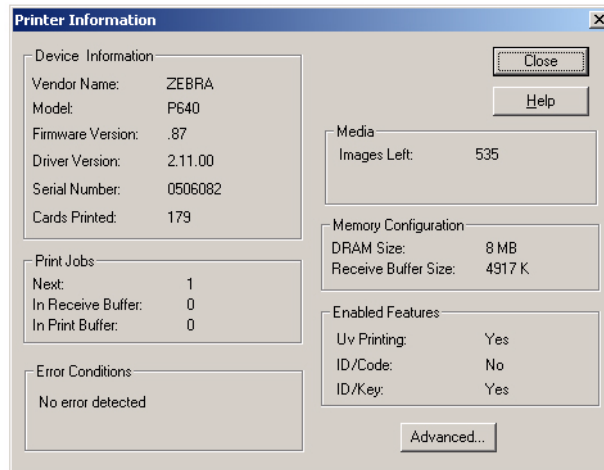

**Control** The following procedures can be performed from the Control screen:

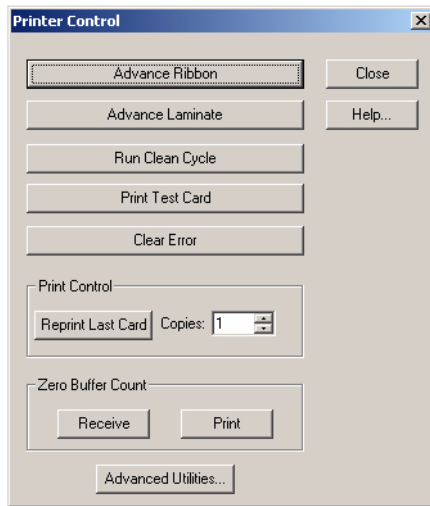

1. Advance the Ribbon
2. Advance the laminate
3. Run a cleaning cycle
4. Print a test card
5. Clear an Error
6. Reprint the last card and select number of copies
7. Zero the buffer
8. Select advanced utilitles such as:
  - a. Flip Test 1
  - b. Flip Test 2
  - c. Flip/Pause
  - d. Move carriage
  - e. Calibration
  - f. Update the backup configuration
  - g. Upgrade the firmware
  - h. Send the features file
  - i. Control the Password
  - j. Control the ID/Code
  - k. Disable the control panel buttons
  - l. Set the printer status

## Printing Preferences

The Preferences screens the operator may be asked to refer to and/or modify are Card Setup, Image Adjustment, YMC (Color) Printing, and K (Black) Panel. To access the Printing Preferences screens, select *Start > Printers (or Printers and Faxes)*, then right click *Zebra P630i* or *Zebra P640i* printer and select Printing Preferences or Properties.

## Card Setup

From the Card Setup screen, the operator can adjust the following settings:

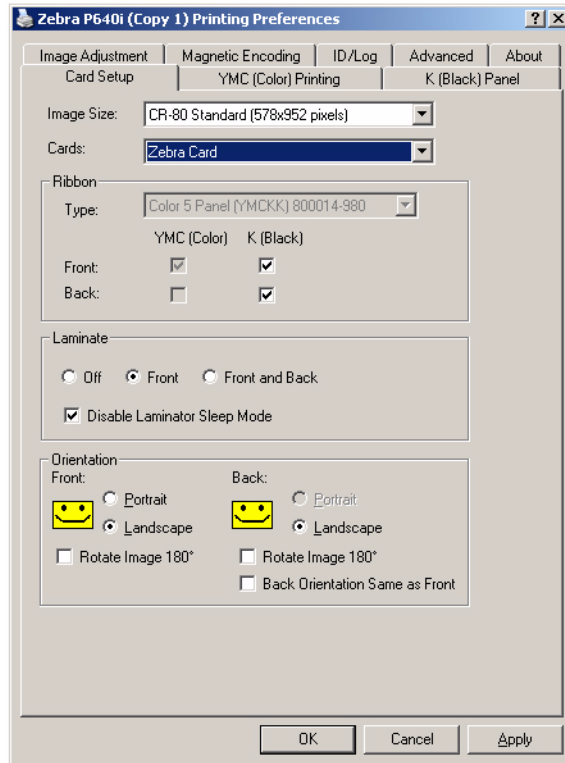

**Image Size** Sets the image area for both front and back of the card (1 inch = 300 pixels).

**Cards** Specifies the type of card loaded in the hopper - typically a PVC/ polyester/PVC composite card for applications where durability is important.

**Ribbon** This is the color ribbon installed in the printer. Choice of two for most applications: YMCK = 3 color panels + 1 black panel, and YMCKK = 3 color panels + 2 black panels. For secure applications a third type of ribbon is available: YMCUvK (“Uv” is a panel of ultraviolet responsive resin).

**Front/Back** Allows you to apply color or black, or both, to either side of the card. For example, with a 4-panel YMCK ribbon the usual arrangement is YMC (Color) on the front, K (Black) on the back. If you check both YMC and K on one side, this sets up a special condition known as black extraction.

**Laminate** Allows you to choose whether laminate will be applied to the front side, to both sides (P640i Printer only), or to neither side.

**Orientation** Allows you to set up the front and back images, independently, for landscape or portrait orientation. By checking the **Rotate** box, you can also flip either image upside down.



**Note** • The following combination is not available: Front landscape and Back portrait.



# Image Adjustment

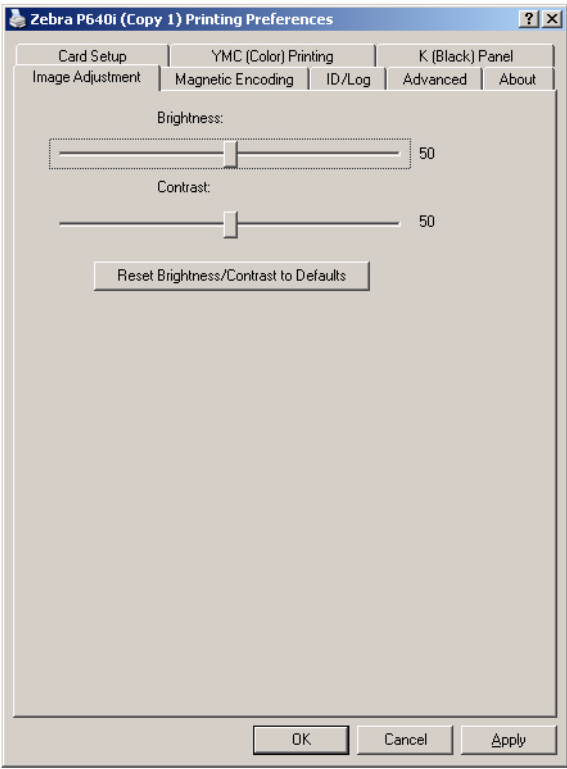

From the **Image Adjustment** screen, the operator can adjust the brightness and contrast of the images printed on the cards. To access the Image Adjustment screen, select *Start > Settings > Printers and Faxes*. Right click on the *Zebra P630i* or *Zebra P640i* printer listing. Select *Printing Preferences > Image Adjustment*.

Brightness and Contrast controls on the **Image Adjustment** screen have same effect on the printed image as do similar controls on typical office color printers. Reference the Contrast and Brightness sample cards below for examples of the different settings available. Click the **Reset Brightness/Contrast to Defaults** button to restore default conditions.

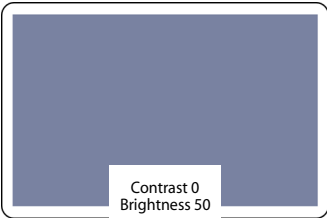

## YMC (Color) Printing



The printer accepts 24-bit color images, meaning that each of the colors (Y, M and C) is represented by 8 bits per pixel. In High Quality, the default setting, all 24 bits are processed. In Low Quality the printer driver transmits a smaller amount of color information, the effect being a slight degradation of the printed image. The advantage of low quality is increased transmission speed, which can be helpful if the connection is through a conventional parallel port. With a USB connection, there will be no noticeable difference.

## K (Black) Panel

When the Card Setup screen is set for YMC and K on the same side of a card, a process called Black Extraction is enabled. The K Panel screen displays available options for Black Extraction.

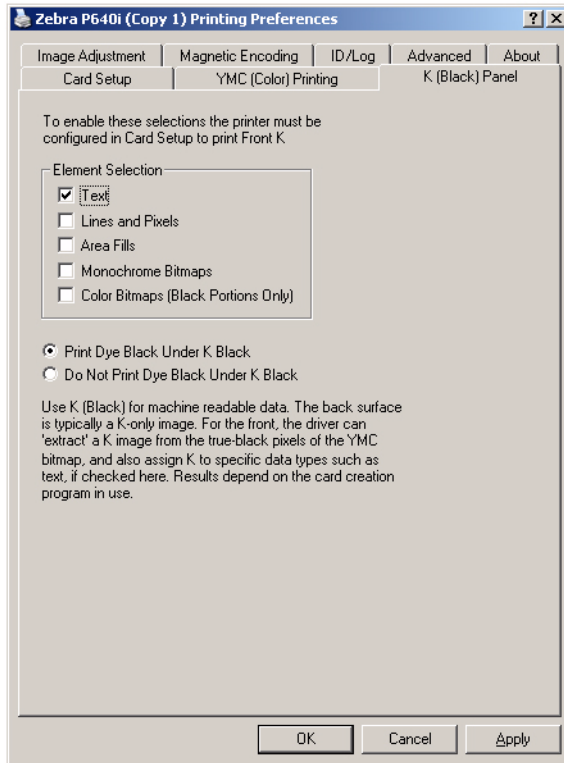

## Black Extraction

Black extraction has to do with the way the printer driver handles the K (black) panel. It applies *only* to surfaces of the card on which *both* YMC (color) *and* K (black) are to be printed.

Equal amounts of Y, M and C dyes, at maximum intensity, deliver a near-black image, but one that is not machine readable. A bar code printed from YMC will be visible to the eye, but will not be detectable by most bar code readers.

The remedy for this is to extract the black; which means printing the same bar code, using the K panel, on top of the YMC bar code. You can also choose to print only in K, omitting YMC from that region. The K panel is not a dye. It is more of a paint containing carbon black, which is highly visible to infrared-type readers.

## Printing Elements

Depending on the application used to create the card layout, elements of the design may be identified in different ways to the printer driver. This printer driver recognizes, and rasterizes, five types of elements: text, lines and pixels, area fills, monochrome bitmaps, and color bit maps:

**Text** Text which is sent explicitly as such to the printer driver.

**Lines and Pixels** Lines and dots (pixels) sent as such to the printer driver.

**Area Fills** Color-filled geometric shapes.

**Monochrome Bitmaps** 1-bit bitmaps (every pixel either black or white).

**Color Bitmaps** Full color uncompressed pixel maps.

The above elements may not always be sent to the driver as expected. For example, a bar code may be sent as text, a series of area fills, or a monochrome bitmap. Results will vary by application used to create the card design. Another variable, again controlled by the card layout application, is the precedence (stacking order) of the various element types in the event that one or more of them overlap.

Any of the above five elements may be selected for black extraction when the ribbon is set up to apply YMC (color) and K (black) to the same surface of the card. In this condition, the driver generates an extracted K image by looking for “true-black” features in the selected element types, that is, instances where all three YMC values are at the maximum (full intensity). Each such true-black instance generates a corresponding cluster of black pixels in the extracted image, which will be printed with the K (black) panel either on top of the YMC image, or replacing it entirely – your choice.

## Color Calibration

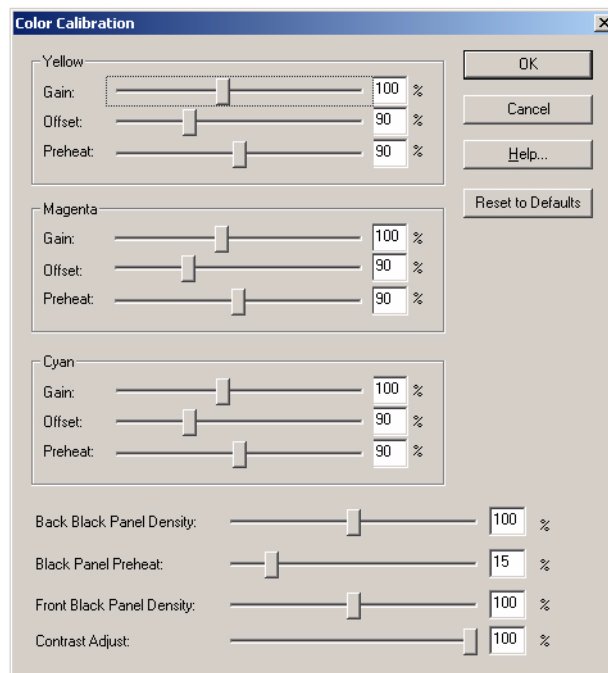

Color rendering in the printer can be described in terms of a curve, which determines how much power is put into the printhead for a given shade. The Y, M and C color curves can be separately modified by the Gain and Offset parameters. Click Restore Defaults if you are not satisfied with adjustments made.

To access the Color Calibration screen, select *Start > Printers (or Printers and Faxes)*. Right click on the *Zebra P630i* or *Zebra P640i* printer listing. Select *Properties > Device Settings > Color Calibration*.

**Offset** Shifts the color curve up (darker) and down (lighter).

**Gain** Adjusts steepness of the curve. Lighter shades will remain unchanged, but darker shades will get darker or lighter as the number is increased or decreased.



**Note** • Typically, the set of values should be the same for each color.

**Preheat** Adjusts how much the head is preheated before each print line (every three hundredths of an inch). A larger value darkens (sharpens) the leading edges of colored areas. A lower value may result in “feathering” - starting light, then darkening over the following few pixels as the head heats up.

**Black Panel Density** This controls the amount of heat energy applied to any pixel required to be black. A higher value gives darker printing, but can cause undesirable blooming (indefinite edges).

**Black Panel Preheat** Temperature offset applied across the entire head, specifically for K panel printing. A higher value results in better resin transfer on the leading edge of graphics and text than you would get with a cold start, but it may lead to undesirable blooming (indefinite edges) overall.



**Note** • The printer must be power cycled for any Contrast Adjustments to take effect.

**Contrast Adjust** A subtle color printing control, allows the user to shape the printer's lightness curve. This means the ability to control how the printer resolves, or differentiates, the lighter and darker shades. Between contrast settings of 0 and 100, the lightness curve transitions from linear to sinusoidal. Linear (0%) tends to result in a low contrast, muddy looking image. Sinusoidal (100%) gives mostly good results, but tends to sacrifice the lightest and darkest shades. For most purposes, select 80% and leave it there.

## Flip Station Routines

To access the Advanced Utilities screen, select *Start > Printers (or Printers and Faxes)*. Right click on the *Zebra P640i* or *Zebra P640i* printer listing. Select *Properties > Device Settings > Control > Advanced Utilities*.

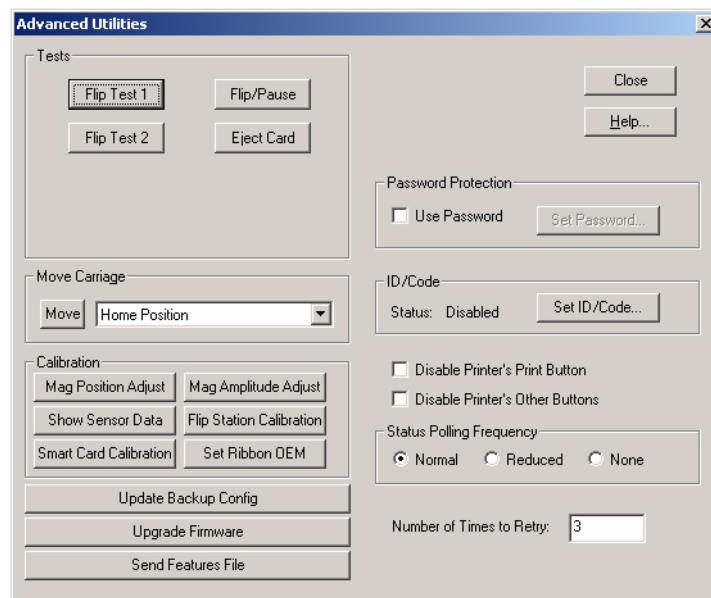

**Flip Test 1** Picks up a card, runs it to the flip station, flips it, raises it to the laminator infeed, then ejects it through the laminator. The sequence repeats until the PRINT button is pressed and released.

**Flip Test 2** Picks up a card, runs it to the flip station, flips it, returns it to the platen, then backs it out to the card sensor (by the mag head). The sequence repeats until the PRINT button is pressed and released.

**Eject Card** Picks up a card, runs it to the flip station, raises it to the laminator infeed, then ejects it through the laminator. Like Flip Test 1, but done once only, and without flipping.

**Flip/Pause** Picks up a card, runs it to the flip station, raises it to the laminator infeed, then holds this position (termed the Insertion Height in the flip station dialog) until the user presses the PRINT button (at which point the flip carrier descends, and the truck returns the card to the hopper).

## Laminator Station Adjustments

Accurate positioning of the laminate is important for practical and aesthetic reasons. The laminate must cover the entire image as printed by the P640i at the time of issuance, thus protecting critical data with a tamper-deterrent film. Additionally, because even the smallest amount of overhang can compromise the card's integrity, the patch should be symmetrically positioned on the card.

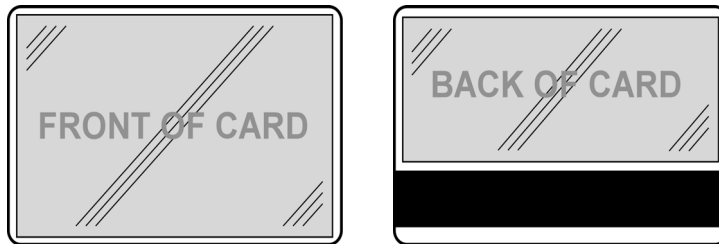

**Note** • If there is no magnetic stripe on the underside, a full width laminate should be used.

To access the Laminate Station Adjustment screen, select *Start > Printers (or Printers and Faxes)*. Right click on the *Zebra P630i* or *Zebra P640i* printer listing. Select *Properties > Device Settings > Printer Adjustment > Laminate Station Adjust*

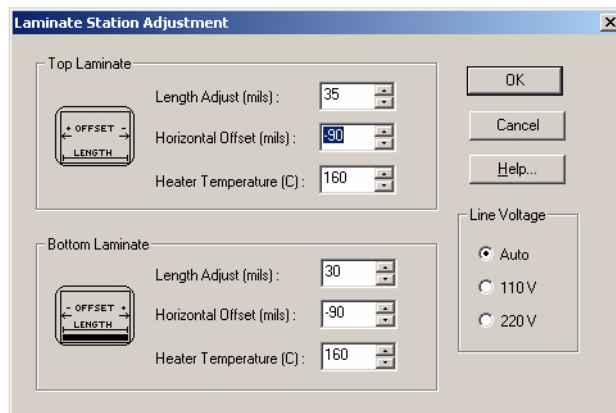

**Length Adjust (mils)** This is the length of the laminate “patch”. If the patch is too long, decrease this number, and vice versa.

**Horizontal Offset (mils)** Adjusts laminate placement on the card.



---

**Caution** • Do not set the temperature ABOVE 180°C, or BELOW room temperature

---

**Heater Temperature** This is the set point - temperature desired - not the actual temperature. For actuals, see Sensor Data, preceding page. NOTE: Temperatures are monitored by thermocouples at the *core* of the heated rollers. Surface temperatures may differ significantly.

**Line Voltage** If Auto is selected, the printer guesses line voltage based on line frequency, assuming that 110V will be @ 60Hz, and 230V @ 50Hz. If this isn't the case in your locality, the printer will guess wrong, and you should set the voltage manually.



---

**Caution** • Running the printer at 220V, 60Hz in Auto mode may cause premature failure of the heaters. Running the printer at 110V, 50Hz in Auto mode may cause abnormally long heat-up time and poor temperature control.

---





# Troubleshooting



## Error Messages

Most error conditions are identified by the printer itself, and are reported by the computer as error messages, with corrective actions listed. The following are typical computer reported error messages.

**CARD STUCK IN LAMINATOR**  
The printer is reporting that the card is stuck in the laminator.  
To Correct:  
1. Turn off the printer power and allow the laminator to cool to a safe handling temperature.  
2. Open the printer cover.  
3. Unscrew the heated roller assembly cartridge retention screw. The cartridge can then be moved/removed to provide access to the lamination path.  
4. Carefully remove card stuck in laminator.  
5. Replace heated roller assembly cartridge and tighten retention screw.  
6. Close the printer cover.  
7. Turn the printer on.  
The card will be reprinted automatically.  
This dialog will automatically disappear once the error is cleared, or you may click "Close" to close it now.

**FLIP STATION JAM**  
The printer is reporting that the flip station is jammed. To correct:  
1. Open the front cover and remove any obstructions from the flip station path. Do not try to manually force the flip station.  
2. Close the front cover. The printer will automatically try to lower the flip station.  
If this error occurred during printing, the card may need to be reprinted. Select "Reprint" to reprint the card, or "Cancel" to cancel the print job.









**RIBBON OUT**  
The printer is reporting a Ribbon Out. The problem might also be that the ribbon is jammed. To correct:  
1. Open the front cover.  
2. Load new ribbon or clear jammed ribbon.  
3. Close the front cover.  
4. Press the Ribbon button on the printer front panel to re-synchronize the ribbon.  
If this error occurred while printing, the card will be reprinted automatically.  
This dialog will close when the error is cleared, or you may click "Close" to close it now.

**MEDIA JAM**  
The printer is reporting a media jam. The problem might be a ribbon jam, laminate out of position, laminate not advancing properly or a card jammed in the laminator. To correct:  
1. Open the cover and determine the cause of the jam and clear the problem.  
For Ribbon Jams:  
2a. Remove the jammed or broken ribbon and reinstall the ribbon into the printer. Close the cover, if ribbon does not automatically resynchronize, press the Ribbon button to resynchronize the ribbon.  
For Laminate Jams:  
2b. Remove both cassettes and check/reset the laminate position to the end of the cassette. Make sure to clear laminate from the flex guide. Replace cassettes in printer and close the cover.  
For Card Jams:  
2c. Remove jammed card from the laminator. Close the cover.  
If this error occurred while printing, the card will be reprinted automatically.  
This dialog box will close automatically once the error is cleared, or you may click "Close" to close it now.

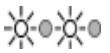
## Indicator Light Status

 = LIGHT ON

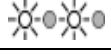
 = LIGHT FLASHING

READY		MEDIA	ALARM	PRINTER STATUS
GREEN	YELLOW	ORANGE	RED	
				Ready to print
				Printer busy
				Laminator heating up, but not yet at operating temperature
				Laminator heaters in sleep mode (when not in use, the heaters cool at 1°F per minute)
				Printhead temperature error, or internal firmware problem.
				No cards in hopper, color ribbon out, cleaning tape out, laminator cassette(s) out.
				Mag encoding write failure
				Serious error conditions, including: Main cover open, Laminator too hot, card transport stalled, card not seated properly, mag encoding verification error, head lift failure, ribbon jam, card jam (any location), card missing (any location), no gap between laminator patches.

## Preventive Maintenance

There is almost no preventive maintenance to be performed. Dust and debris should be vacuumed out every 12 months, or more frequently in adverse environments.

Most of the problems described in the following pages are correctable by the user, but please note there is the potential for unexpected results if the procedures are not followed carefully. If in doubt, call Zebra Technical Support.

Before calling for technical support, do the following:

- Check all cable connections, including power.
- Check that the power switch is ON.
- Unless you hear noises suggesting a card jam condition, try power cycling: switch OFF, wait 15 seconds, then switch ON.
- Open the main cover, then look for obvious problems, such as a card where it shouldn't be, media outages or misfeeds (color ribbon, laminate, cleaning cassette).

## Unusual Noises/Unreported Events

### Color ribbon runs for longer than 2 or 3 seconds when cover is closed (MEDIA light stays on)

- Color ribbon not in ribbon sensor.
- Both ribbon cores not fully engaged on spindles.
- Ribbon not secured to takeup core.
- No ribbon type or wrong ribbon type specified in Printer Properties. Reference Printing Preferences in Chapter 4, Settings and Adjustments.

### ALARM light stays ON after error condition is cleared



**Note** • There is a delay after closing the cover before the ALARM light goes out.

- Some alarms require recycling power in order to clear
- Main cover interlock switch may not have actuated when cover closed.
- Alarm condition not corrected.

### Card has both front and back images printed on same side

- Check selections made in Printing Preferences > Card Setup in Chapter 4, Settings and Adjustments.
- Card failed to flip. Run Flip Test to check flip action. Reference Chapter 4, Settings and Adjustments

### MEDIA light ON steady, but no obvious visual problem

- Color ribbon not in ribbon sensor.
- Color ribbon supply and/or takeup cores not engaging properly on spindles.
- Cleaning cassette not engaging properly on the takeup drive.

### Completely unexpected print results

- Color ribbon out, or nearly out. Replace ribbon.
- Main cover opened during a print job. Open and close main cover, then press RIBBON to re-sync ribbon. Reprint last job.
- Color ribbon panels out of sync, see previous action.
- Color ribbon not advancing consistently. Color ribbon supply and/or takeup cores not engaging properly on spindles.
- Front (color side) of card printed with black. Open and close main cover, then press RIBBON to re-sync ribbon.
- Inconsistent color, very faint printing. Printhead not pressing on ribbon. Contact Zebra Customer Service.

- Color ribbon torn, or jamming intermittently. Clear jam. Pull out more from supply roll and reattach to takeup roll.

#### YMC color panels stick to card

- Printhead running too hot. Can happen after head replacement if head resistance incorrectly entered through printer driver. Contact Zebra Customer Service.
- Color gain and offset too high. Contact Zebra Customer Service.
- Check ribbon takeup and supply torques. Contact Zebra Customer Service.

#### K (Black) panel sticks to card

- Printhead running too hot. Can happen after head replacement if head resistance incorrectly entered through printer driver. Contact Zebra Customer Service.
- Black panel density and/or preheat set too high. Contact Zebra Customer Service.
- Check ribbon takeup and supply torques. Contact Zebra Customer Service.
- Color image printing with K (black) panel. Check selections made in Printing Preferences

#### Loud rattling/screeching from card transport

- Card has fallen onto truck drive belt, and is jammed at some point. Open cover, remove all cards from hopper. Remove jammed card if accessible. Look for card in the transport bed. Using card transport knob, hand-crank truck to push card into one of two areas for easy removal - under hopper, or under flip station (lift carrier for access, then push it down again).

#### Rattling noise every 10 cards

- Cleaning cassette not firmly engaged.
- Cleaning cassette broken or cassette halves separated.
- Cleaning cassette cannot rotate upward to disengage from the cleaning roller. Pivot arm screw too tight or too loose?.

#### Unusual events

In any of the following cases, and all other unusual events, try power cycling first, then investigate specific issues:

- Printhead descends before card arrives. Contact Zebra Customer Service.
- Printhead stays down after card has gone away. Contact Zebra Customer Service.
- Laminate cutter fails to operate
- Unusual media light indications.

## Laminator spot check



**Note** • Remember, the P640i Printer includes upper and lower laminators; the P630i Printer has the upper laminator only.

- Make sure the transfer roller toggle is in the operating position, pointing to the right.
- Upper or lower laminate feed problems: remove, then replace transfer guides, discarding laminate patches on transfer rollers. Check for laminate where it shouldn't be. Remove both laminate cassettes. If out, or nearly out, load fresh laminate. Wind laminate back in to eliminate overhang. Reinstall cassettes, latching securely. Visually check path from cassette(s) through feed roller, cutter and transfer guide.
- Check for misfeeding of laminate due to poor engagement of white plastic idler on cassette with drive roller. Mark the upper core to check that it rotates (no need to mark the lower core - watch the notches on the laminate core). Feed laminate by pressing the LAMINATE button.
- Laminate patch may be wrapped around the heated roller, causing card feed problems and/or poor lamination. Turn printer OFF, allow 10 minutes for cooling, then remove heated rollers - careful, they will still be HOT. Remove the rogue patch. Do NOT use a metal knife or any tool that might damage the heated rollers.
- Check upper and lower laminate sensor readings, with and without laminate present (< 20 if present, > 180 if absent - numbers valid only if transfer guides installed).

## Quality Problems



---

**Important** • Operator should contact Zebra Card Printer Solutions Customer Service before changing any factory settings within the printer.

---

### Poor color registration

- Minor mis-registration of Y, M and C color passes may be due to printhead angle adjust screw not in firm contact with printhead frame.
- For gross mis-registration of Y, M and C, suspect that the card not firmly positioned against left hand pick edge of truck on one or more passes. Spring at left end of platen may be missing or bound up.
- Check printed card for damage on corners or edges. Example: the card may be scraping along the underside of the hopper base molding.
- Printhead pressure too light.
- Printhead may be running hot. Will occur if head resistance incorrectly entered in driver software.
- Toothed transport belt pulley may be slipping on drive shaft. Tighten set screws (make sure the screws bear on flats on the shafts).

- Toothed transport belt wrong length.

### Poor color rendering



---

**Important** • Changes in contrast settings will not take effect until power is cycled.

---

- Possible source issues - poor quality photos or graphics, card layout application settings. Isolate the problem by printing a known image, such as Portraits.bmp, through IDPrint Lite.
- Vary brightness and contrast controls in *Preferences > Image Adjustment*. Fine tune if necessary using Contrast Adjust in *Properties > Device Settings > Color Calibration*.

### Faint, non-uniform image

- Printhead pressure too low. Adjust downward.
- Printhead not pivoting freely.

### Gaps in image at edges and corners

- Possible de-lamination/wear of platen's rubber surface. Try cleaning platen. If unsuccessful, replace platen.
- Possible non-uniformity of card thickness, or card surface defects.

### Continuous white or black stripes on card's longer dimension

- Before doing anything else, clean the printing edge of the printhead with alcohol.
- White stripe means blown pixel (non-functioning heating element). One or two blown pixels in isolation may be acceptable to some. Otherwise replace printhead.
- Black stripe means non-functioning circuit(s) on printhead. If so, replace printhead, but first check that it is not the result of an image size change not followed by power cycling the printer.

## Laminate Problems

### Laminate not centered on card

- Vertical offset adjust (mechanical adjustment).
- Horizontal offset: *Properties > Device Settings > Printer Adjustment > Laminate Station Adjust.*

### Laminate not parallel with card edges

- Skew adjust (mechanical adjustment).
- If using partial width laminate, edge guide not properly installed (one of two positions).
- Transfer guide not properly installed.
- Laminate patch wrapped around heated roller.

### Laminate wrinkling

- Can occur at end of roll. Remove cassette. If nearly out, discard. Install fresh roll.
- If not end-of-roll problem, suspect obstructions in laminate feed path.

## Examples of Printhead Failures

### White line across length of the card

- The white line is a sign of a blown pixel.
- The adjacent black stripe is a printhead driver problem (components on the head itself).
- These are independent problems, not necessarily co-located, that may require replacement of the printhead.

### Random occurrences of white (unprinted) spots

- Possible card quality problem. Run IDPrint Lite with [graytone.bmp](#) on cards from a different batch. Check platen surface for specks of debris.

### Image not centered on card

- *Properties > Device Settings > Printer Adjustment > Horizontal/Vertical Offset.*

### Image offset on card

- Correct this by increasing horizontal (X) offset, decreasing vertical (Y) offset.

### **Image missing at top or bottom of card**

- Ribbon folded over at edge. Slacken ribbon by pulling more out of supply roll, unfold edge then press RIBBON button to re-sync.
- Bottom edge and/or right hand edge of image missing could be card layout application sending wrong image size (should be 952 x 578 pixels). Select appropriate image size (if available) in Preferences, or modify layout application.

### **Image loss at top of card**

- Could be on either edge. Almost certainly due to ribbon fold-over, but could be a head non-pivoting problem, or an image size problem.

### **Consistent image defects, card after card**

- Debris on platen, or platen surface not flat. Clean platen, or replace if necessary.

### **Debris on platen**

- Clean platen.

### **Random colored patterns on image**

- Ribbon wrinkling. Reduce takeup torque. Check printhead pressure.
- Too much heat being applied to YMC panels. Try reducing gain, offset and preheat separately for each color in the driver *Device Settings > Color Calibration*. Typically, the set of values should be the same for each color.
- Printhead running too hot. Can happen after head replacement if head resistance incorrectly entered through printer driver.

### **Random colored lines**

- Probably resulting from excessive takeup torque.

### **Scratches/dings on long edges of card**

- Look for a narrow band of abrasion up to about 0.1" (2.5 mm) in from either or both of the long edges.
- Card hopper base set too low.

## **System Related Issues**

- Printer self-test takes more than a few minutes to complete
- READY indicator LED is not lit on the panel

### **Invalid IP address**



A valid static unique IP address must be assigned to the printer. The default setting has DHCP disabled. If you do not specify either, the printer may incur an extended latency while being identified in your network. Refer to your operating system networking configuration instructions to set up a unique static or DHCP selected IP address for your Ethernet-enabled printer.

## **DHCP is enabled but the printer is not connected to your network**

Verify that the Ethernet cable is properly connected to the printer and to the Ethernet port on your computer or the network.

## **Valid host name has not been assigned to the printer**

If your client uses Windows 2000, a valid host name must be assigned to the printer. Failing to do so may cause DHCP to register the IP address as the printer name in DDNS for clients that do not support dynamic updates.

## **Color differences may be attributable to the Windows operating system installed**

In a multi-printer installation, the colors printed on one unit do not match the colors from another, even though the printer color settings are the same.

To ensure color consistency, it is recommended that the identical operating system and settings be used on all computers generating print jobs.





---

# Technical Specifications

## P640*i* Specifications

**Card size:** ISO CR-80 (2.125" x 3.385"), 30 mil thick

**Card hopper:** 150 cards

**Throughput:** 120 cards/hour (YMC on front, K on back)

**Print system:** Single printhead, with flip station for front and back printing. Dye sublimation for YMC colors, and thermal mass transfer for K and Uv panels (K = opaque black resin, Uv = clear ultraviolet-visible resin).

**Printhead resolution:** 300 dpi

**Image size (typical):** 952 pixels (3.17") x 578 pixels (1.93")

**Magnetic stripe encoder (option):** Hi-Co type. 3-track, ISO and AAMVA compatible. Custom formattable through Windows printer driver.

**Cleaning system:** Both card faces cleaned by high-tack roller. Roller is refreshed automatically by transfer tape at selectable intervals (typically 10 cards).

**Laminating system:** P640*i*: Separate laminators for front and back surfaces of card. (P630*i*: Single laminator for front surface of card.) Waste-free design with built-in cutters. Continuous 1 mil (0.025 mm) thick polyester film in reloadable cassettes.

**Controls:** Print, Ribbon advance, Laminate advance

**Indicators:** Ready to print, Media outage, Alarm

**Data interface:** USB, Parallel (option), 10/100 Mbps Ethernet (option)

**Windows drivers:** Plug-and-Play 2000, XP

**Technical Specifications**  
P640i Specifications

**Security features:** ID/Key (option), a hardware lockout, an ID/Code, and a printer-to-PC password lockout

**Compliances:** FCC Class A, UL/IEC/EN 60950-1

**Power requirements:** 110 - 220 VAC, 50 - 60Hz, 4 - 2 A

**Environment:** Operating: 50° to 95°F (10° to 35°C), 20 to 80% RH non-condensing.  
Storage: -4° to 158°F (-20° to 70°C), 5 to 90% RH non-condensing

**Dimensions:** see drawing

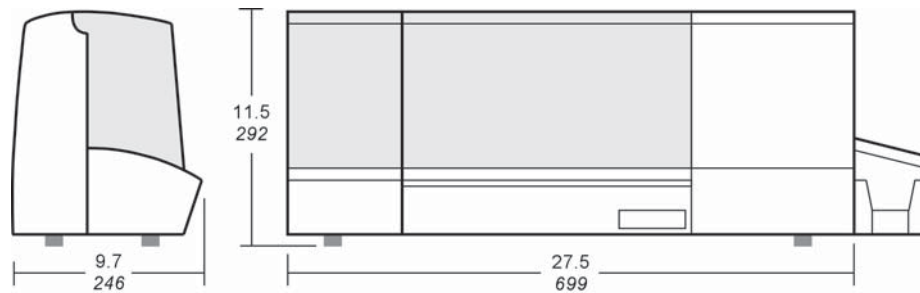

**Net weight:** 35 lb. (15.9 kg) net. Shipping weight 43 lb. (19.5 kg).

# Appendix A

## Magnetic Encoder



### Magnetic Card Stripe Encoder

This section contains information on the additional operations of the P630i or P640i Printer with Magnetic Card Stripe Encoder. The magnetic encoder uses high coercivity.

#### ISO Standard Encoding

Track #	Field Separator	Track Density	Valid Characters	# of characters
1	^	210 BPI*	Alphanumeric (ASCII 20~95†)	79‡
2	=	75 BPI*	Numeric (ASCII 48~62)	40‡
3	=	210 BPI*	Numeric (ASCII 48~62)	107‡

\*Bits per inch  
†Except the “?” character  
‡Including Start, Stop, and LRC characters. Also note that these 3 characters are automatically managed by the magnetic encoder according to the ISO Standard Norms.



**Note** • Refer to the Card Printer Programmer’s Manual for complete programming information.

## AAMVA Standard Encoding

Track #	Field Separator	Track Density	Valid Characters	# of characters
1	%	210 BPI*	Alphanumeric	82‡
2	:	75 BPI*	Numeric	40‡
3	%	210 BPI*	Alphanumeric	82‡

\*Bits per inch  
‡Including Start, Stop, and LRC characters. Also note that these 3 characters are automatically managed by the magnetic encoder according to the ISO Standard Norms.

## Magnetic Encoder Cleaning

Use the standard cleaning procedures. This cleans the most important parts of the printer; including the print Head, Transport Roller and Magnetic Stripe Encoder.

## Media Loading Orientation



---

**Caution** • ONLY USE cards that comply with ISO 7810 & 7811 standards for magnetic stripe cards. The magnetic stripe must be flush to the surface of the card to work properly. Never use cards which have taped-on magnetic stripes.

---

When loading cards with magnetic stripes into the card feeder, please ensure that the magnetic stripe is face up, facing the front of the printer.

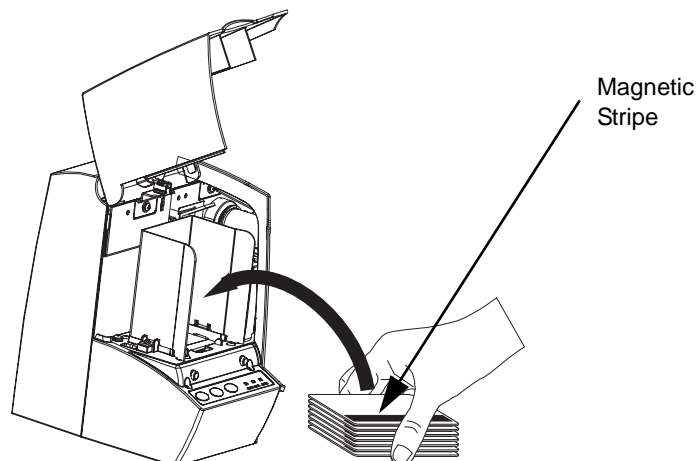

# Appendix B

## Smart Card Contact Station



### Introduction

This section contains information on the additional operations of a P630*i* or P640*i* Printer equipped with the optional Smart Card Contact Station. Smart Cards have a built-in microcomputer and/or memory chip, which is used to store fingerprints, voice recognition patterns, medical records, or other types of data. The printer may be equipped with an optional contact station for programming Smart Cards (ISO 7816). This printer model responds to commands that position the card at the contact station, where the printer connects to the contacts on the Smart Card. All other printer operations remain the same as the standard model.

### Media Loading Orientation

Orient the cards with the gold-plated Smart Card contacts at the bottom surface of the card and facing to the right.

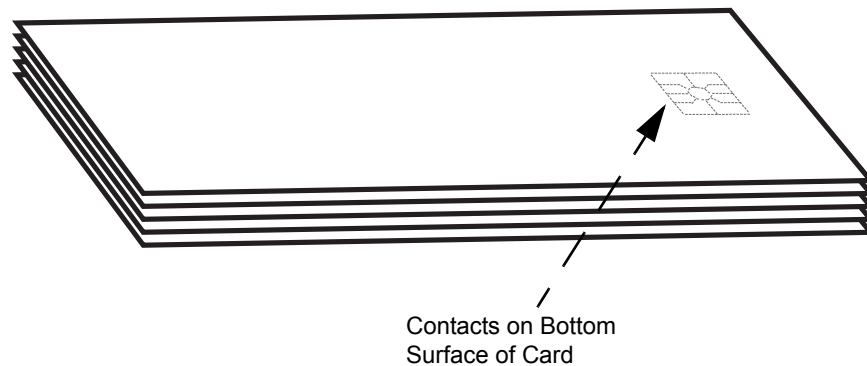

## Laminating Smart Cards

The laminating patch on the top surface of a smart card has a rectangular aperture to expose the card's electrical contacts. In all other respects the laminating process for smart cards is the same as for ordinary cards.

The special laminate for the top cassette is punched with a repeated pattern. Loading procedure for smart card laminate is exactly the same as for standard laminate as shown in Chapter 2.

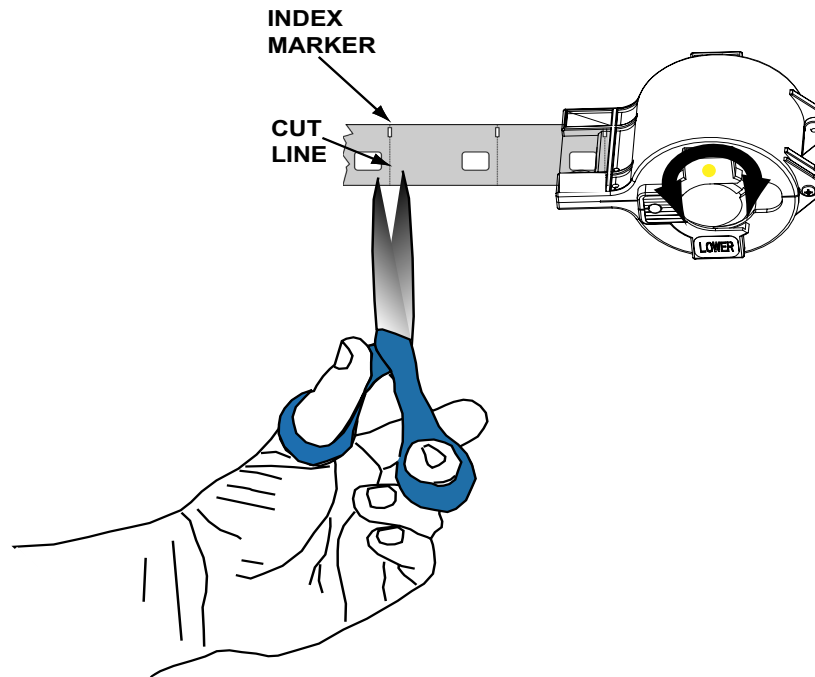

The smaller hole is an index marker that tells the printer where to cut the laminate, *exactly* splitting the index hole (the printer driver allows adjustment of the cut location). After loading the Smart Card laminate in the upper cassette, trim the laminate along the cut line as shown.



# Appendix C

## Printer Security



### ID/Key

IDKey

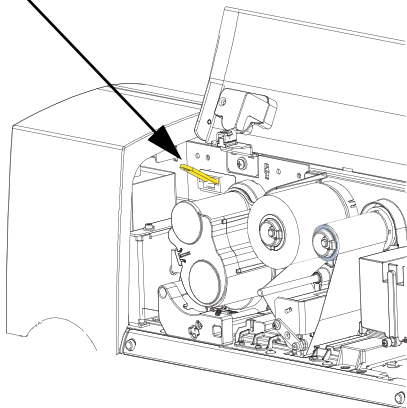

The optional ID/Key is a physical security key that is programmed for each specific P630i or P640i printer. It is intended to prevent unauthorized use of that printer.

The ID/Key has a non-alterable memory containing a unique 64-bit serial number that is compared prior to each print job with a serial number stored in the printer's nonvolatile RAM. If the serial numbers fail to match, or if no ID/Key is detected, the printer is disabled. The ID/Key is carried in a 2" x 3/4" plastic fob that plugs into a receptacle to the right of the card hopper. Typically, at the end of each work session the ID/Key is removed from the printer and stored in a secure location such as a key safe.

### Replacing a Lost ID/Key



**Important** • If the ID/Key is removed during a card printing session, the printer will cease to operate after the current batch of cards is printed.

The recovery procedure requires a special computer file obtainable only from Zebra product support. This file is downloaded to the printer, following which the replacement ID/Key is inserted. The printer is then power cycled, off then on, at which point the key's serial number is recorded in NVRAM.

## Printer Parameters in the Driver

### ID/Code



The ID/Code, or password, synchronizes the driver with the printer. This prevents use of the printer with a PC not having the same ID/Code. The initial ID/Code is assigned at the factory during manufacture. The factory assigned code is located on a sticker on the underside of the ID/Key. To change this code, select *Start > Printers (or Printers and Faxes)*. Right click *Zebra P630i*, or *Zebra P640i*, then select *Properties > Device Settings > Control > Advanced Utilities*. In the Change ID/Code window, enter the old password from the underside of the ID/Key in the Old Password field. Enter a new password in the New Password field, and enter the same password in the Confirmation field. To disable the ID/Code function, leave the New Password and Confirmation fields blank. When completed, click the OK button

### Update Backup Config

Most of the parameters affecting operation of the printer are set up using the printer driver, and are then saved in the printer's flash memory as the current configuration. The original factory configuration also resides in a separate backup memory, allowing you to recover the as-shipped settings.

The **Update Backup Config** command instructs the printer to replace the factory configuration with the current configuration, but do not do this casually. Once the current configuration replaces the factory configuration, you can no longer return the printer to the factory settings.

### Restoring the Backup Configuration Settings

Revert to **Backup Config** as follows:

- Step 1.** Power OFF
- Step 2.** Remove the color ribbon

**Step 3.** Press and hold the PRINT, RIBBON and LAMINATE buttons at the same time as you switch on the power

**Step 4.** Release the three buttons when you see activity in the printer.

## **Password Protection**

Password protection is not the same as ID/Code. Password protection blocks access to various low level printer adjustment screens. On the appropriate screen, check **Use Password**, then enter a password of your choice.



# Appendix D

## Worldwide Sales & Support

---



### Sales and Support Locations

Zebra Technologies  
Card Printer Solutions  
1001 Flynn Road  
Camarillo, CA 93012-8706 USA  
Phone: + 1 (805) 579 1800  
Fax: + 1 (805) 579 1808  
Toll free in US: (800) 452-4056  
e-mail: [cards@zebra.com](mailto:cards@zebra.com)

Zebra Technologies  
Card Printer Solutions, Europe, Middle East, Africa  
The Valley Centre, Gordon Road, High Wycombe  
Buckinghamshire HP13 6EQ, England  
Phone: + 44 (0) 870 241 1527  
Fax: + 44 (0) 870 241 0765  
e-mail: [eurosales@zebra.com](mailto:eurosales@zebra.com)

Zebra Technologies  
Card Printer Solutions, Latin America  
9800 NW 41st Street, Suite 220  
Doral, FL 33178 USA  
Phone: + 1 (305) 558 8470  
Fax: + 1 (305) 558-8485  
e-mail: [latinsales@card.com](mailto:latinsales@card.com)

**Worldwide Sales & Support**  
Corporate Headquarters

Zebra Technologies  
Card Printer Solutions, Asia/Pacific  
1 Sims Lane # 06-11  
387355 Singapore  
Phone: + 65 84 20 322  
Fax: + 65 84 20 514  
e-mail: [asiasales@zebra.com](mailto:asiasales@zebra.com)

## **Corporate Headquarters**

Zebra Technologies Corporation  
333 Corporate Woods Parkway  
Vernon Hills, IL 60061-3109 USA  
Phone: + 1 (847) 634 6700  
Fax: + 1 (847) 913 8766  
e-mail: [sales@zebra.com](mailto:sales@zebra.com)

## **Website**

[www.zebracard.com](http://www.zebracard.com)