

DS457 FIXED MOUNT IMAGER INTEGRATION GUIDE

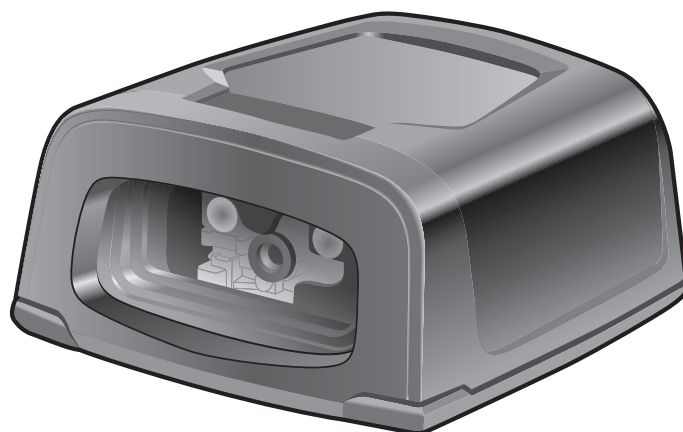

DS457 FIXED MOUNT IMAGER INTEGRATION GUIDE

72E-144361-05

Revision A

December 2017

No part of this publication may be reproduced or used in any form, or by any electrical or mechanical means, without permission in writing from Zebra. This includes electronic or mechanical means, such as photocopying, recording, or information storage and retrieval systems. The material in this manual is subject to change without notice.

The software is provided strictly on an “as is” basis. All software, including firmware, furnished to the user is on a licensed basis. Zebra grants to the user a non-transferable and non-exclusive license to use each software or firmware program delivered hereunder (licensed program). Except as noted below, such license may not be assigned, sublicensed, or otherwise transferred by the user without prior written consent of Zebra. No right to copy a licensed program in whole or in part is granted, except as permitted under copyright law. The user shall not modify, merge, or incorporate any form or portion of a licensed program with other program material, create a derivative work from a licensed program, or use a licensed program in a network without written permission from Zebra. The user agrees to maintain Zebra’s copyright notice on the licensed programs delivered hereunder, and to include the same on any authorized copies it makes, in whole or in part. The user agrees not to decompile, disassemble, decode, or reverse engineer any licensed program delivered to the user or any portion thereof.

Zebra reserves the right to make changes to any software or product to improve reliability, function, or design.

Zebra does not assume any product liability arising out of, or in connection with, the application or use of any product, circuit, or application described herein.

No license is granted, either expressly or by implication, estoppel, or otherwise under any Zebra Technologies Corporation intellectual property rights. An implied license only exists for equipment, circuits, and subsystems contained in Zebra products.

ZEBRA, ZEBRA TECHNOLOGIES and the Stylized Z logo are trademarks of ZIH Corp, registered in many jurisdictions worldwide. All product names and numbers are Zebra trademarks. The Symbol logo is a registered trademark of Symbol Technologies, Inc., a Zebra Technologies company.

This media, or Zebra Product, may include Zebra Software, Commercial Third Party Software, and Publicly Available Software.

The Zebra Software that may be included on this media, or included in the Zebra Product, is Copyright (c) by Zebra Technologies Corporation, and its use is subject to the licenses, terms and conditions of the agreement in force between the purchaser of the Zebra Product.

The Commercial Third Party Software that may be included on this media, or included in the Zebra Product, is subject to the licenses, terms and conditions of the agreement in force between the purchaser of the Zebra Product and Zebra Technologies Corporation, unless a separate Commercial Third Party Software License is included, in which case, your use of the Commercial Third Party Software will then be governed by the separate Commercial Third Party License.

The Publicly Available Software that may be included on this media, or in the Zebra Product, is listed below. The use of the listed Publicly Available Software is subject to the licenses, terms and conditions of the agreement in force between the purchaser of the Zebra Product and Zebra Technologies Corporation, as well as, the terms and conditions of the license of each Publicly Available Software package. Copies of the licenses for the listed Publicly Available Software, as well as, all attributions, acknowledgements, and software information details, are included below. Zebra is required to reproduce the software licenses, acknowledgments and copyright notices as provided by the Authors and Owners, thus, all such information is provided in its native language form, without modification or translation.

The Publicly Available Software in the list below is limited to the Publicly Available Software included by Zebra. The Publicly Available Software included by Commercial Third Party Software or Products, that is used in the Zebra Product, are disclosed in the Commercial Third Party Licenses, or via the respective Commercial Third Party Publicly Available Software Legal Notices.

Publicly available software list:

Name: Regular Expression Evaluator
 Version: 8.3
 Description: Compiles and executes regular expressions
 Software Site: <http://www.freebsd.org/cgi/cvsweb.cgi/src/lib/libc/regex/>
 Source Code: No Source Distribution Obligations. Zebra will not provide nor distribute the Source Code for the Regular Expression Evaluator.
 License: BSD Style License

© 1992 Henry Spencer.

© 1992, 1993 The Regents of the University of California. All rights reserved.

This code is derived from software contributed to Berkeley by Henry Spencer of the University of Toronto. Redistribution and use in source and binary forms, with or without modification, are permitted provided that the following conditions are met:

1. Redistributions of source code must retain the above copyright notice, this list of conditions and the following disclaimer.
2. Redistributions in binary form must reproduce the above copyright notice, this list of conditions and the following disclaimer in the documentation and/or other materials provided with the distribution.
3. All advertising materials mentioning features or use of this software must display the following acknowledgement:

This product includes software developed by the University of California, Berkeley and its contributors.

4. Neither the name of the University nor the names of its contributors may be used to endorse or promote products derived from this software without specific prior written permission.

THIS SOFTWARE IS PROVIDED BY THE REGENTS AND CONTRIBUTORS "AS IS" AND ANY EXPRESS OR IMPLIED WARRANTIES, INCLUDING, BUT NOT LIMITED TO, THE IMPLIED WARRANTIES OF MERCHANTABILITY AND FITNESS FOR A PARTICULAR PURPOSE ARE DISCLAIMED. IN NO EVENT SHALL THE REGENTS OR CONTRIBUTORS BE LIABLE FOR ANY DIRECT, INDIRECT, INCIDENTAL, SPECIAL, EXEMPLARY, OR CONSEQUENTIAL DAMAGES (INCLUDING, BUT NOT LIMITED TO, PROCUREMENT OF SUBSTITUTE GOODS OR SERVICES; LOSS OF USE, DATA, OR PROFITS; OR BUSINESS INTERRUPTION) HOWEVER CAUSED AND ON ANY THEORY OF LIABILITY, WHETHER IN CONTRACT, STRICT LIABILITY, OR TORT (INCLUDING NEGLIGENCE OR OTHERWISE) ARISING IN ANY WAY OUT OF THE USE OF THIS SOFTWARE, EVEN IF ADVISED OF THE POSSIBILITY OF SUCH DAMAGE.

Warranty

For the complete Zebra hardware product warranty statement, go to:

<http://www.zebra.com/warranty>

Revision History

Changes to the original guide are listed below:

Change	Date	Description
-01 Rev A	6/2011	Initial release
-02 Rev A	9/2012	Clarify that SSI is the default serial host; update URLs and service information, update 123Scan2 chapter, update Driver's License Setup chapter to remove server based parsing algorithms and jurisdictional updates references
-03 Rev A	4/2014	<ul style="list-style-type: none"> - Added parameter attribute numbers. - Added Presentation Performance Mode, Time Delay to Presentation Idle Mode, Time Delay to Presentation Sleep Mode, and Power Up Light in Presentation Mode. - Removed Motion Enhancement in Presentation Mode parameter and sub-parameters. - Added Unique Bar Code Reporting. - Added Multicode Mode Concatenation and Multicode Concatenation Symbology. - Moved Miscellaneous Parameters chapter content into User Preferences chapter. - Added Video Mode Format Selector. - Added CUTE serial host. - Added code types to serial host parameters table. - For USB Device Type: <ul style="list-style-type: none"> - Change HID Keyboard Emulation to USB Keyboard (HID). - Change USB OPOS Hand-Held to IBM OPOS (IBM Hand-Held USB with Full Scan Disable) and added related note. - Added following parameters to USB chapter: Quick Keypad Emulation, USB Ignore Beep Directive, USB Ignore Type Directive, USB Polling Interval, Fast HID, IBM Specification Level. - Added new OCR-B Variant options and OCR Inverse parameter. - Added Code 128, Code 39, and I 2 of 5 Security Levels. - Added Codabar Upper or Lower Case Start/Stop Character Transmission. - Added GS1 DataBar Limited Security Level. - Updated defaults for the following parameters: PDF Prioritization Timeout, JPEG Size Value, Image File Meta Data, Image Edge Sharpening, I 2 of 5 Lengths, US Postnet, US Planet, UK Postal, Japan Postal, Australia Post, Netherlands KIX Code, GS1 DataBar Limited, UPC Composite Mode, Decode Mirror Images, Maxicode, Aztec Inverse - Updated 123Scan2 chapter.
-04 Rev A	3/2015	Zebra Re-branding, add statement to temperature specification.
-05 Rev A	12/2017	<p>Updated SSI Baud Rate bar code caption values Changed USB Keyboard HID to USB HID Keyboard Changed IBM OPOS (IBM Hand-Held USB with Full Scan Disable) option to OPOS (IBM Hand-held with Full Disable) Changed GS1 DataBar-14 references to GS1 DataBar Omnidirectional Updated 123Scan chapter Removed Glossary</p>

TABLE OF CONTENTS

About This Guide

Introduction	xv
Configurations	xv
Chapter Descriptions	xv
Notational Conventions	xvi
Related Documents	xvii
Service Information	xviii

Chapter 1: Getting Started

Overview	1-1
DS457 Features	1-2
Theory of Operation	1-2
DS457 Block Diagram Descriptions	1-3
DS457 Decoder/Interface Board	1-4

Chapter 2: Installation

Overview	2-1
Unpacking	2-1
Mounting	2-2
DS457 Mounting Dimensions	2-2
Mounting the Imager on the Gooseneck Stand	2-3
Mounting the Imager on the POS Stand	2-5
Mounting the Imager on the MS320X Conversion Mounting Bracket	2-7
Connecting the DS457	2-8
USB Host Connection	2-8
Serial Host Connection	2-9
Trigger Jack Connector Pins	2-10
Location and Positioning	2-10
Embedded Applications Requiring a Window	2-11
Window Material	2-11
Window Coatings	2-12
Embedded Window Angle and Position	2-13

Recommended Exit Window Information	2-15
Exit Window Notes	2-15
Accessories	2-16
Simple Serial Interface Software Developer's Kit (SSI SDK)	2-17
Zebra SNAPi Software Developer's Kit	2-17

Chapter 3: Imaging

Overview	3-1
Imaging System	3-1
Aiming Pattern	3-1
Aiming Error	3-1
Aiming Control	3-2
Illumination System	3-2
Illumination Control	3-2
Frame Rate Control	3-2
Capturing Data	3-3
Beeper and Decode LED Indications	3-4
Supported Symbologies	3-5
Operating Modes	3-5

Chapter 4: Specifications

Electrical Interface	4-1
Dimension Drawings	4-2
DS457 Imager Technical Specifications	4-3
Skew, Pitch and Roll	4-5
Decode Zones	4-6
DS457-SR/DL	4-6
DS457-HD/DP	4-9

Chapter 5: Maintenance & Troubleshooting

Overview	5-1
Maintenance	5-1
Cleaning the Connector	5-1
Troubleshooting	5-2

Chapter 6: User Preferences

Introduction	6-1
Host Selection	6-1
Phantom Scan Session	6-1
Changing Default Values	6-2
Scanning Sequence Examples	6-2
Errors While Scanning	6-2
User Preferences Parameter Defaults	6-3
User Preferences	6-5
Set Default Parameter	6-5
Parameter Scanning	6-6
User Parameter Pass Through	6-7

Beep After Good Decode	6-8
Beeper Tone	6-9
Beeper Volume	6-10
Suppress Power-up Beeps	6-10
Trigger Mode	6-11
Presentation Performance Mode	6-12
Power Mode (RS-232 Hosts Only)	6-17
Time Delay to Low Power Mode	6-17
Picklist Mode	6-19
Decode Session Timeout	6-19
Timeout Between Decodes, Same Symbol	6-20
Continuous Bar Code Read	6-20
Unique Bar Code Reporting	6-21
Mirrored Image	6-21
Mobile Phone/Display Mode	6-22
Validate Concatenated Parameter Bar Codes	6-22
PDF Prioritization	6-23
PDF Prioritization Timeout	6-23
Multicode Mode	6-24
Multicode Expression	6-25
Multicode Mode Concatenation	6-33
Multicode Concatenation Symbology	6-34
Multicode Troubleshooting	6-35
Miscellaneous Parameters	6-37
Transmit Code ID Character	6-37
Prefix/Suffix Values	6-38
Scan Data Transmission Format	6-39
FN1 Substitution Values	6-40
Transmit "No Read" Message	6-41
Report Version	6-41

Chapter 7: Imager Preferences

Introduction	7-1
Scanning Sequence Examples	7-2
Errors While Scanning	7-2
Imager Preferences Parameter Defaults	7-2
Imager Preferences	7-4
Operational Modes	7-4
Decoding Autoexposure	7-5
Decoding Illumination	7-6
Decode Aiming Pattern	7-6
Aim Brightness	7-7
Illumination Brightness	7-7
Low Light Enhancement	7-8
Power Up Light in Presentation Mode	7-8
Presentation Mode Field of View	7-9
Frame Rate	7-10
Image Capture Autoexposure	7-12
Image Capture Illumination	7-12
Fixed Gain	7-13

Exposure Time	7-13
Snapshot Mode Timeout	7-14
Snapshot Aiming Pattern	7-14
Presentation Snapshot by Motion	7-15
Continuous Snapshot	7-15
Image Cropping	7-16
Crop to Pixel Addresses	7-17
Image Resolution	7-18
Image Brightness (Target White)	7-19
Image File Format Selector	7-20
JPEG Image Options	7-20
JPEG Quality and Size Value	7-21
Image File Meta Data	7-22
Image Enhancement	7-23
Image Edge Sharpening	7-24
Image Contrast Enhancement	7-25
Image Rotation	7-26
Bits per Pixel	7-27
Signature Capture	7-28
Signature Capture File Format Selector	7-29
Signature Capture Bits per Pixel	7-30
Signature Capture Width	7-30
Signature Capture Height	7-31
Signature Capture JPEG Quality	7-31
Video Mode Format Selector	7-32
Video View Finder	7-32
Target Video Frame Size	7-33
Video View Finder Image Size	7-33
Video Resolution	7-34

Chapter 8: SSI Interface

Introduction	8-1
Communications	8-1
SSI Transactions	8-3
General Data Transactions	8-3
Transfer of Decode Data	8-4
Communication Summary	8-5
RTS/CTS Lines	8-5
ACK/NAK Option	8-5
Number of Data Bits	8-5
Serial Response Time-out	8-5
Retries	8-5
Baud Rate, Stop Bits, Parity, Response Time-out, ACK/NAK Handshake	8-6
Errors	8-6
Things to Remember When Using SSI Communication	8-6
Using Time Delay to Low Power Mode with SSI	8-7
Simple Serial Interface Default Parameters	8-8
SSI Host Parameters	8-9
Select SSI Host	8-9
Baud Rate	8-10

Parity	8-11
Check Parity	8-12
Software Handshaking	8-12
Host RTS Line State	8-13
Decode Data Packet Format	8-13
Host Serial Response Time-out	8-14
Host Character Time-out	8-15
Multipacket Option	8-16
Interpacket Delay	8-17
Event Reporting	8-18
Decode Event	8-18
Boot Up Event	8-19
Parameter Event	8-19

Chapter 9: Serial Interface

Introduction	9-1
Serial Parameter Defaults	9-2
Serial Host Parameters	9-3
Serial Host Types	9-5
Baud Rate	9-7
Parity	9-9
Data Bits	9-9
Check Receive Errors	9-10
Hardware Handshaking	9-11
Software Handshaking	9-13
Host Serial Response Time-out	9-15
RTS Line State	9-16
Beep on <BEL>	9-16
Intercharacter Delay	9-17
Nixdorf Beep/LED Options	9-18
Ignore Unknown Characters	9-18
ASCII Character Set for Serial Hosts	9-19

Chapter 10: USB Interface

Introduction	10-1
USB Parameter Defaults	10-2
USB Host Parameters	10-3
USB Device Type	10-3
Symbol Native API (SNAPI) Status Handshaking	10-5
USB Country Keyboard Types (Country Codes)	10-6
USB Keystroke Delay	10-8
USB CAPS Lock Override	10-8
USB Ignore Unknown Characters	10-9
Emulate Keypad	10-9
Emulate Keypad with Leading Zero	10-10
Quick Keypad Emulation	10-10
USB Keyboard FN1 Substitution	10-11
Function Key Mapping	10-11
Simulated Caps Lock	10-12

Convert Case	10-13
USB Static CDC	10-13
USB Ignore Beep Directive	10-14
USB Ignore Type Directive	10-14
USB Polling Interval	10-15
Fast HID Keyboard	10-17
IBM Specification Level	10-17
ASCII Character Set for USB	10-18

Chapter 11: OCR Reading

Introduction	11-1
OCR Parameter Defaults	11-2
OCR Parameters	11-3
Enable/Disable OCR-A	11-3
OCR-A Variant	11-3
Enable/Disable OCR-B	11-5
OCR-B Variant	11-6
Enable/Disable MICR E13B	11-9
Enable/Disable US Currency Serial Number	11-10
OCR Orientation	11-10
OCR Lines	11-12
OCR Minimum Characters	11-13
OCR Maximum Characters	11-13
OCR Security Level	11-13
OCR Subset	11-14
OCR Quiet Zone	11-14
OCR Bright Illumination	11-15
OCR Template	11-16
OCR Check Digit Modulus	11-25
OCR Check Digit Multiplier	11-26
OCR Check Digit Validation	11-27
Inverse OCR	11-31

Chapter 12: Symbolologies

Introduction	12-1
Scanning Sequence Examples	12-2
Errors While Scanning	12-2
Symbology Parameter Defaults	12-2
Disable All Symbolologies	12-8
UPC/EAN	12-9
Enable/Disable UPC-A	12-9
Enable/Disable UPC-E	12-9
Enable/Disable UPC-E1	12-10
Enable/Disable EAN-8/JAN-8	12-10
Enable/Disable EAN-13/JAN-13	12-11
Enable/Disable Bookland EAN	12-11
Decode UPC/EAN/JAN Supplementals	12-12
User-Programmable Supplementals	12-15
UPC/EAN/JAN Supplemental Redundancy	12-15

UPC/EAN/JAN Supplemental AIM ID Format	12-16
Transmit UPC-A Check Digit	12-17
Transmit UPC-E Check Digit	12-17
Transmit UPC-E1 Check Digit	12-18
UPC-A Preamble	12-19
UPC-E Preamble	12-20
UPC-E1 Preamble	12-21
Convert UPC-E to UPC-A	12-22
Convert UPC-E1 to UPC-A	12-22
EAN-8/JAN-8 Extend	12-23
Bookland ISBN Format	12-24
UCC Coupon Extended Code	12-25
Coupon Report	12-26
ISSN EAN	12-27
Code 128	12-28
Enable/Disable Code 128	12-28
Set Lengths for Code 128	12-28
Enable/Disable GS1-128 (formerly UCC/EAN-128)	12-30
Enable/Disable ISBT 128	12-30
ISBT Concatenation	12-31
Check ISBT Table	12-32
ISBT Concatenation Redundancy	12-32
Code 128 Security Level	12-33
Code 39	12-34
Enable/Disable Code 39	12-34
Enable/Disable Trioptic Code 39	12-34
Convert Code 39 to Code 32	12-35
Code 32 Prefix	12-35
Set Lengths for Code 39	12-36
Code 39 Check Digit Verification	12-37
Transmit Code 39 Check Digit	12-38
Code 39 Full ASCII Conversion	12-38
Code 39 Buffering (Scan & Store)	12-39
Code 39 Security Level	12-42
Code 93	12-43
Enable/Disable Code 93	12-43
Set Lengths for Code 93	12-43
Code 11	12-45
Code 11	12-45
Set Lengths for Code 11	12-45
Code 11 Check Digit Verification	12-47
Transmit Code 11 Check Digits	12-48
Interleaved 2 of 5 (ITF)	12-48
Enable/Disable Interleaved 2 of 5	12-48
Set Lengths for Interleaved 2 of 5	12-49
I 2 of 5 Check Digit Verification	12-50
Transmit I 2 of 5 Check Digit	12-51
Convert I 2 of 5 to EAN-13	12-51
I 2 of 5 Security Level	12-52

Discrete 2 of 5 (DTF)	12-53
Enable/Disable Discrete 2 of 5	12-53
Set Lengths for Discrete 2 of 5	12-53
Codabar (NW - 7)	12-55
Enable/Disable Codabar	12-55
Set Lengths for Codabar	12-55
CLSI Editing	12-57
NOTIS Editing	12-57
Codabar Upper or Lower Case Start/Stop Characters Transmission	12-58
MSI	12-59
Enable/Disable MSI	12-59
Set Lengths for MSI	12-59
MSI Check Digits	12-61
Transmit MSI Check Digit(s)	12-62
MSI Check Digit Algorithm	12-62
Chinese 2 of 5	12-63
Enable/Disable Chinese 2 of 5	12-63
Matrix 2 of 5	12-63
Enable/Disable Matrix 2 of 5	12-63
Set Lengths for Matrix 2 of 5	12-64
Matrix 2 of 5 Check Digit	12-65
Transmit Matrix 2 of 5 Check Digit	12-65
Korean 3 of 5	12-66
Enable/Disable Korean 3 of 5	12-66
Inverse 1D	12-67
Postal Codes	12-68
US Postnet	12-68
US Planet	12-68
Transmit US Postal Check Digit	12-69
UK Postal	12-69
Transmit UK Postal Check Digit	12-70
Japan Postal	12-70
Australia Post	12-71
Australia Post Format	12-72
Netherlands KIX Code	12-73
USPS 4CB/One Code/Intelligent Mail	12-74
UPU FICS Postal	12-74
GS1 DataBar (formerly RSS, Reduced Space Symbology)	12-75
GS1 DataBar	12-75
GS1 DataBar Limited	12-76
GS1 DataBar Limited Security Level	12-77
GS1 DataBar Expanded	12-78
Convert GS1 DataBar to UPC/EAN	12-78
Composite	12-79
Composite CC-C	12-79
Composite CC-A/B	12-79
Composite TLC-39	12-80
UPC Composite Mode	12-81
Composite Beep Mode	12-82
GS1-128 Emulation Mode for UCC/EAN Composite Codes	12-82

2D Symbolologies	12-83
Enable/Disable PDF417	12-83
Enable/Disable MicroPDF417	12-83
Code 128 Emulation	12-84
Data Matrix	12-85
Data Matrix Inverse	12-86
Decode Mirror Images (Data Matrix Only)	12-87
Maxicode	12-88
QR Code	12-88
QR Inverse	12-89
MicroQR	12-90
Aztec	12-90
Aztec Inverse	12-91
Redundancy Level	12-92
Security Level	12-94
Intercharacter Gap Size	12-95
Macro PDF Features	12-96
Macro PDF User Indications	12-96
Macro PDF Transmit / Decode Mode Symbols	12-97
Transmit Macro PDF Control Header	12-98
Escape Characters	12-98
Flush Macro Buffer	12-99
Abort Macro PDF Entry	12-99
Chapter 13: Driver's License Set Up (DS457-DL)	
Introduction	13-1
Driver's License Parsing	13-1
Parsing Driver's License Data Fields (Embedded Driver's License Parsing)	13-2
Embedded Driver's License Parsing Criteria - Code Type	13-2
Driver's License Parse Field Bar Codes	13-3
AAMVA Parse Field Bar Codes	13-6
Parsing Rule Example	13-16
Embedded Driver's License Parsing ADF Example	13-20
Field Update Procedure	13-22
User Preferences	13-23
Set Default Parameter	13-23
Send Keystroke (Control Characters and Keyboard Characters)	13-23
Chapter 14: 123Scan	
Introduction	14-1
Communication with 123Scan	14-1
123Scan Requirements	14-2
Scanner SDK, Other Software Tools, and Videos	14-2
Chapter 15: Advanced Data Formatting	
Introduction	15-1

Appendix A: Standard Default Parameters

Default Parameters	A-1
Reserved Parameters	A-13

Appendix B: Programming Reference

Code Identifiers	B-1
AIM Code Identifiers	B-1

Appendix C: Sample Bar Codes

Code 39	C-1
UPC/EAN	C-1
UPC-A, 100 %	C-1
EAN-13, 100 %	C-1
Code 128	C-2
Interleaved 2 of 5	C-2
GS1 DataBar Omnidirectional	C-2
PDF417	C-2
Data Matrix	C-3
Maxicode	C-3

Appendix D: Numeric Bar Codes

Numeric Bar Codes	D-1
Cancel	D-3

Appendix E: ASCII Character Set

Index

ABOUT THIS GUIDE

Introduction

The *DS457 Fixed Mount Imager Integration Guide* provides general instructions for mounting, setting up, and programming the DS457 fixed mount imager.

Configurations

The DS457 offers the following configurations:

- DS457-SR - Standard range imager
- DS457-HD - High density imager
- DS457-DP - High density imager with Direct Part Marking (DPM) software
- DS457-DL - Standard range imager, driver's license parsing

Chapter Descriptions

Topics covered in this guide are as follows:

- [Chapter 1, Getting Started](#) provides an overview of the DS457 imager, including applications and a theory of operation.
- [Chapter 2, Installation](#) provides mounting and connection information for the DS457, and lists accessories.
- [Chapter 3, Imaging](#) provides information on the aiming and illumination system, and includes imaging tips and a list of supported symbologies.
- [Chapter 4, Specifications](#) provides technical specifications including electrical and mechanical information, and provides decode ranges.
- [Chapter 5, Maintenance & Troubleshooting](#) provides maintenance and troubleshooting tips.
- [Chapter 6, User Preferences](#) provides programming bar codes for selecting user preference features.
- [Chapter 7, Imager Preferences](#) provides programming bar codes for selecting imager preference features.

- [Chapter 8, SSI Interface](#) describes how to set up the decoder with a Simple Serial Interface (SSI) host. Use SSI to program the decoder via bar code menu or SSI hosts commands.
- [Chapter 9, Serial Interface](#) describes how to set up the decoder with a serial host. Use the serial interface to connect the decoder to point-of-sale devices, host computers, or other devices with an available serial port (e.g., com port).
- [Chapter 10, USB Interface](#) describes how to set up the decoder with a USB host. The decoder connects directly to a USB host, or a powered USB hub, and is powered by it.
- [Chapter 11, OCR Reading](#) describes how to set up the decoder for OCR programming.
- [Chapter 12, Symbologies](#) describes all symbology features and provides the programming bar codes necessary for selecting these features for the decoder.
- [Chapter 13, Driver's License Set Up \(DS457-DL\)](#) describes how to program the DS457-DL imager to read and use the data contained in the 2D bar codes on US driver's licenses and AAMVA compliant ID cards.
- [Chapter 14, 123Scan](#) provides information on the PC-based software tool that enables rapid and easy customized setup of scanners by Zebra.
- [Chapter 15, Advanced Data Formatting](#) provides instructions for using ADF, a means of customizing data before transmission to the host device.
- [Appendix A, Standard Default Parameters](#) provides a table of all host and miscellaneous defaults.
- [Appendix B, Programming Reference](#) provides a table of AIM code identifiers, ASCII character conversions, and keyboard maps.
- [Appendix C, Sample Bar Codes](#) includes sample bar codes of various code types.
- [Appendix D, Numeric Bar Codes](#) includes the numeric bar codes to scan for parameters requiring specific numeric values.
- [Appendix E, ASCII Character Set](#) provides ASCII character value tables.

Notational Conventions

The following conventions are used in this document:

- “Imager” refers to the DS457 imager
- “Engine” or “imaging engine” refers to the SE4500 imaging engine.
- *Italics* highlight chapters and sections in this and related documents
- Bullets (•) indicate:
 - action items
 - lists of alternatives
 - lists of required steps that are not necessarily sequential.
- Sequential lists (e.g., those that describe step-by-step procedures) appear as numbered lists.

- Throughout the programming bar code menus, asterisks (*) are used to denote default parameter settings.



✓ **NOTE** This symbol indicates something of special interest or importance to the reader. Failure to read the note will not result in physical harm to the reader, equipment or data.



CAUTION This symbol indicates that if this information is ignored, the possibility of data or material damage may occur.



WARNING! This symbol indicates that if this information is ignored the possibility that serious personal injury may occur.

Related Documents

- DS457 Fixed Mount Imager Quick Reference Guide*, p/n 72-144417-xx, provides information for setting up the DS457.
- Simple Serial Interface (SSI) Programmer Guide*, p/n 72E-40451-xx, provides system requirements and programming information about the Simple Serial Interface, which enables Zebra devices to communicate with a serial host.
- Symbol Native Application Programming Interface (SNAPI) Programmer Guide*, p/n 72E-71370-xx, describes the Symbol Native Application Programming Interface (SNAPI), a development library used to implement USB communication between a Zebra scanner and a Windows 98/2000/XP host.
- Advanced Data Formatting Programmer Guide*, p/n 72E-69680-xx, provides bar codes and instructions for advanced programming of Zebra scanners and imagers.

For the latest version of these guides and software, and all Zebra guides, go to: <http://www.zebra.com/support>.

Service Information

If you have a problem using the equipment, contact your facility's technical or systems support. If there is a problem with the equipment, they will contact the Zebra Global Customer Support Center at: <http://www.zebra.com/support>.

When contacting Zebra support, please have the following information available:

- Serial number of the unit
- Model number or product name
- Software type and version number

Zebra responds to calls by e-mail, telephone or fax within the time limits set forth in service agreements.

If your problem cannot be solved by Zebra support, you may need to return your equipment for servicing and will be given specific directions. Zebra is not responsible for any damages incurred during shipment if the approved shipping container is not used. Shipping the units improperly can possibly void the warranty.

If you purchased your business product from a Zebra business partner, please contact that business partner for support.

CHAPTER 1 GETTING STARTED

Overview



CAUTION Use of controls, adjustments or procedures other than those specified here can result in hazardous laser light exposure.

The DS457 fixed-mount imager is specifically designed for standalone applications and OEM applications. The imager is extremely compact, provides easy and flexible integration into a host device, and offers high-performance imaging on 1D and 2D bar codes. The DS457 is ideal for a wide variety of uses: zero-footprint point-of-sale, kiosks, embedded diagnostic equipment, conveyor belts, and many more.

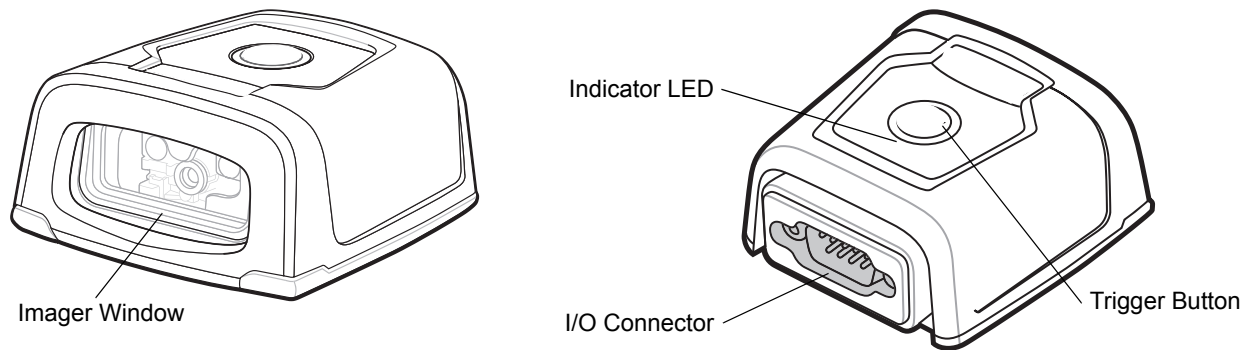

Figure 1-1 DS457 Fixed Mount Imager

This integration guide includes programming parameters and describes the theory of operation, installation, specifications, and configuration.

DS457 Features

- Quick and easy integration for OEM devices
- Excellent imaging performance on all 1D and 2D bar codes
- RS-232 (serial) or USB interface
- Excellent motion tolerance
- LEDs indicating power status and successful decodes
- Trigger button for manual triggering
- Small footprint optimal for "Zero Footprint" POS scanning applications
- Direct Part Marking (DPM) support (DPM version only). Scan 2D symbols etched directly onto an item's surface (via laser etching and dot peening) for permanent identification.
- Driver's license (DL) parsing (DL version only)
- Easy programming and configuration
- Integrated threaded mounting screw holes
- Flexible mounting options
- IP54 sealing

Theory of Operation

During image capture:

1. The image sensor array in the embedded SE4500 imaging engine captures an image of the bar code through the engine's optical lens. If necessary, the engine automatically adjusts illumination, exposure, and other parameters to obtain the best quality image.
2. The imaging engine sends the image to the DS457 CPU.
3. The DS457 CPU processes the image to identify the target bar code(s), decodes them, and transmits the decoded data to the host.

Set various parameters provided in this guide to adjust the performance of the DS457 to match the application or desired usage profile.

Block Diagram

The DS457 imager block diagram illustrates the functional relationship of the DS457 components. This section also provides a description of each component in the block diagrams.

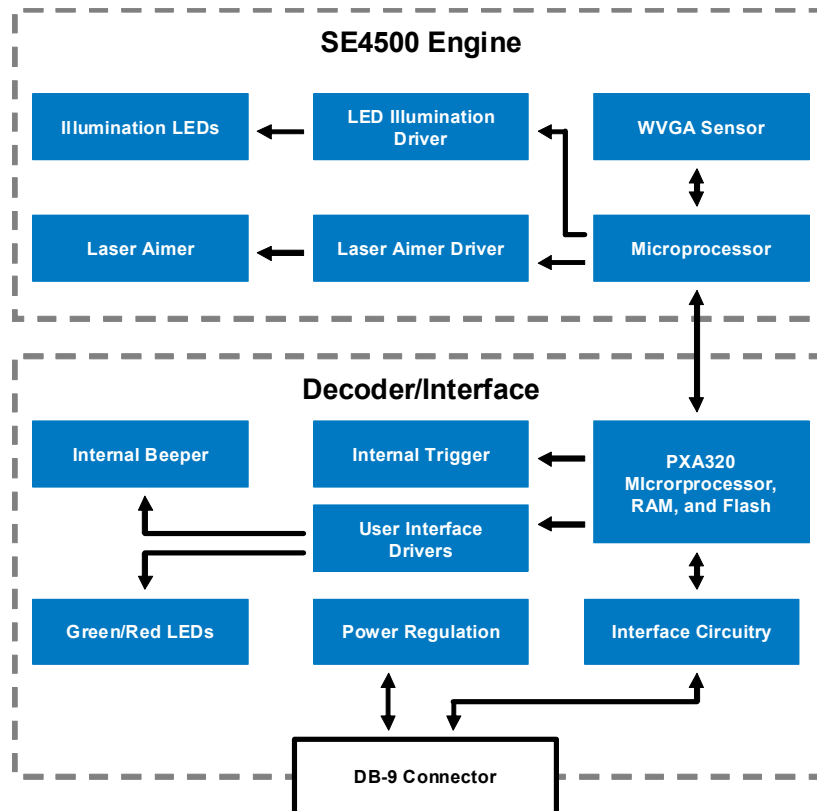

Figure 1-2 DS457 Block Diagram

DS457 Block Diagram Descriptions

SE4500 Imaging Engine - The SE4500 imaging engine captures 8-bit gray scale WVGA images at up to 60 fps, which are sent uncompressed to a companion board for processing. The engine uses a red laser for intuitive aiming and features LED illumination. The engine is available in two focusing configurations, providing a choice between high resolution and longer depth of field.

DS457 Decoder/Interface Board - The decoder/interface board is a companion decoder module for the SE4500 imaging engine, which controls the engine, receives images, decodes 1D and 2D symbologies, and performs various image processing tasks. The board controls a beeper and red and green LEDs for acoustic and visual feedback, respectively. It also provides imaging for an external trigger and external beeper via the DB9 connector. The board supports asynchronous serial (the standard Symbol Simple Serial Interface/SSI command set) and SNAPi (Symbol Native API) interfaces, as well as a variety of other USB and RS-232 host interfaces.

DB9 - The DB9 connector provides an outlet for the various interface signals used between the DS457 and the host. It also provides power to the unit.

DS457 Decoder/Interface Board

Marvell PXA320 Processor

The digital system is built on a Marvell PXA320 (Intel XScale[®]) super-pipelined RISC microarchitecture core. The major features of the core are:

- CPU clock speed up to 624 MHz with external DDR SDRAM bus speed of 133 MHz.
- 32 KB instruction/32 KB data L1 cache, 256 KB unified L2 cache, 728 KB internal SRAM

Power Management

The DS457 decoder/interface board has various power management options depending on the host interface.

- **USB (SNAPI, USB HID Keyboard, etc.)** - The DS457 automatically manages its power usage, including USB suspend mode. Additionally, when drawing power from the USB bus, the DS457 does not exceed the USB limit of 500 mA.
- **SSI or RS-232** - When using SSI or any RS-232 host interface, the DS457 uses one of the following power modes. See [Power Mode \(RS-232 Hosts Only\) on page 6-17](#).
 - Continuous Power: The DS457 is fully awake and running, even when not in a decode session.
 - Low Power (default): The DS457 draws less current at idle than when in Continuous Power mode.

CHAPTER 2 INSTALLATION

Overview

This chapter provides information on unpacking, mounting, and installing the imager.

Unpacking

Remove the DS457 from its packing and inspect for damage. If the imager is damaged, call Zebra Global Customer Support on [page xviii](#).

KEEP THE PACKING. It is the approved shipping container and should be used if the equipment needs to be returned for servicing.

Mounting

There are two M3 x .5 tapped holes on the bottom of the DS457 housing for mounting. The following figures provide the mounting dimensions.



NOTE Do not use screws that penetrate more than 3.5 mm into the bottom mousing of the DS457 since this is the maximum depth of the useful thread.

DS457 Mounting Dimensions

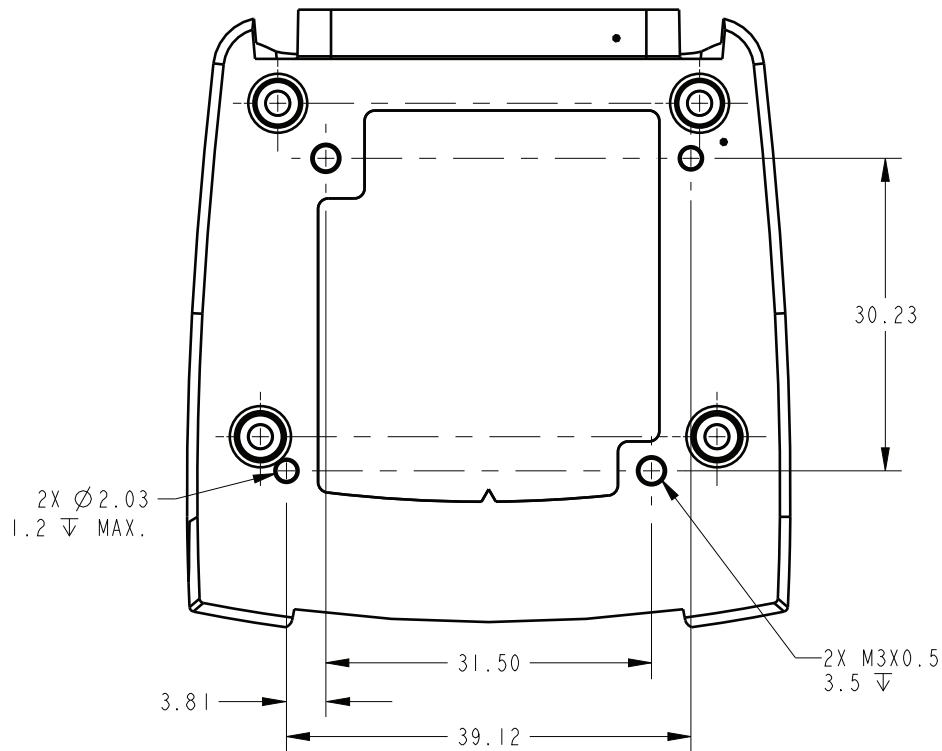

Note: Dimensions are in mm.

Figure 2-1 DS457 Mounting Dimensions

Mounting the Imager on the Gooseneck Stand

To mount the imager on the optional gooseneck stand:

1. Mount the DS457 to the mount plate. Align the imager so its window faces the short edge of the plate, and its two threaded inserts align with the stand's two mounting holes that are closest to the edge of the plastic. Note that the imager requires only two screws for mounting.
2. Secure the imager to the stand using the two screws provided with the stand.

Assembling the Stand

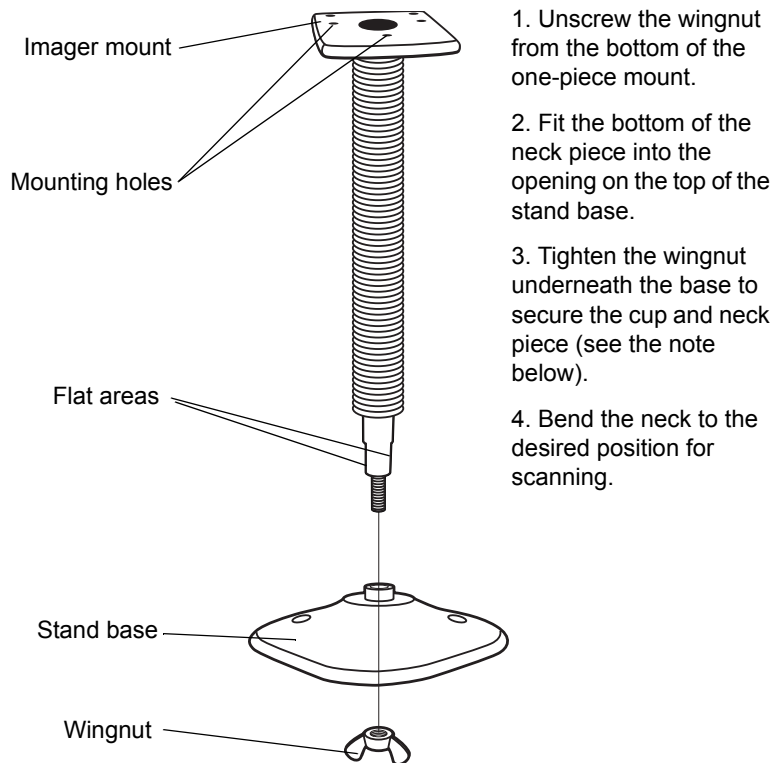

Figure 2-2 *Assembling the Gooseneck Stand*



NOTE Before tightening the wingnut under the base, ensure that the flat areas on the flexible neck fit securely in the grooves in the base.

Mounting the Stand (optional)

You can attach the base of the stand to a flat surface using two screws or double-sided tape (not provided).

Screw Mount

1. Position the assembled base on a flat surface.
2. Screw one #10 wood screw into each screw-mount hole until the base of the stand is secure.

Tape Mount

1. Peel the paper liner off one side of each piece of tape and place the sticky surface over each of the three rectangular tape areas.
2. Peel the paper liner off the exposed sides of each piece of tape and press the stand on a flat surface until it is secure.

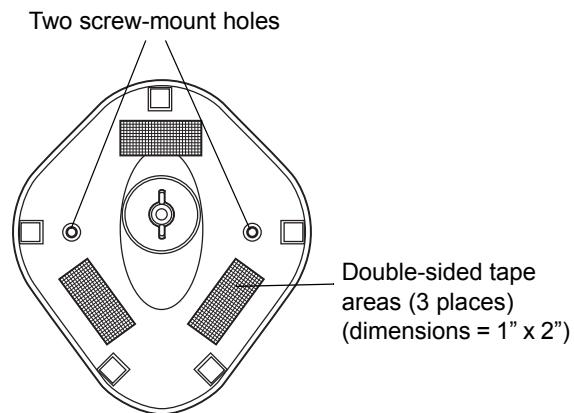

Figure 2-3 *Mounting the Stand*

Mounting the Imager on the POS Stand

To mount the imager on the optional POS stand:

1. Mount the imager to the bracket assembly using the two mounting screws provided.

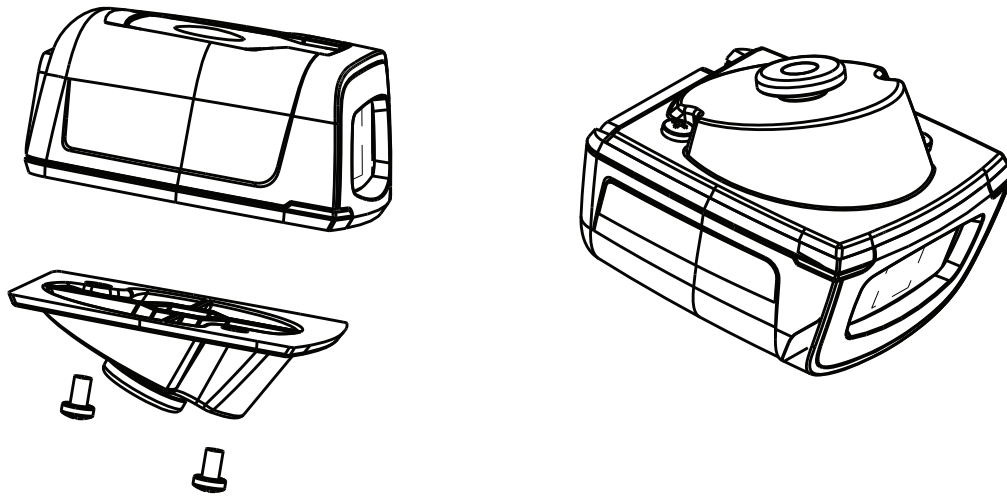

Figure 2-4 *Mounting Imager on Bracket Assembly*

2. Secure the microphone-style clip to the mounting surface using the two screws provided.

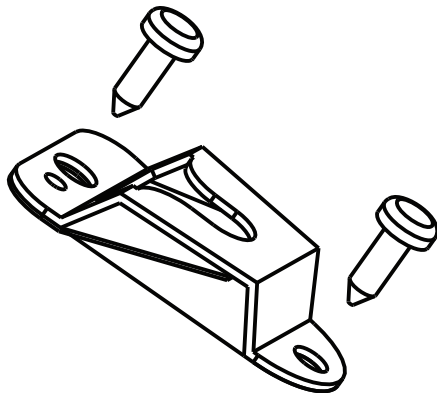

Figure 2-5 *Securing Microphone Clip*

3. Slide the bracket assembly with the imager attached onto the microphone-style clip.

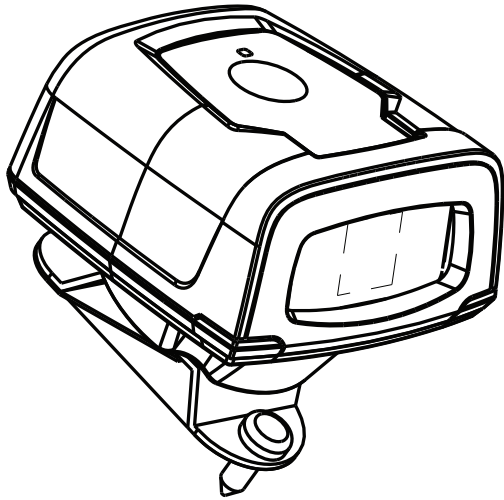

Figure 2-6 *Assembling the POS Stand*

Mounting the Imager on the MS320X Conversion Mounting Bracket

To mount the imager on an existing MS320X mounting bracket:

1. Remove the MS320X from its original mounting.
2. Mount the DS457 imager to the conversion mounting bracket using the two mounting screws provided.
3. Place the conversion bracket on top of the existing MS320X bracket, aligning the standoffs with the existing mounting screws.

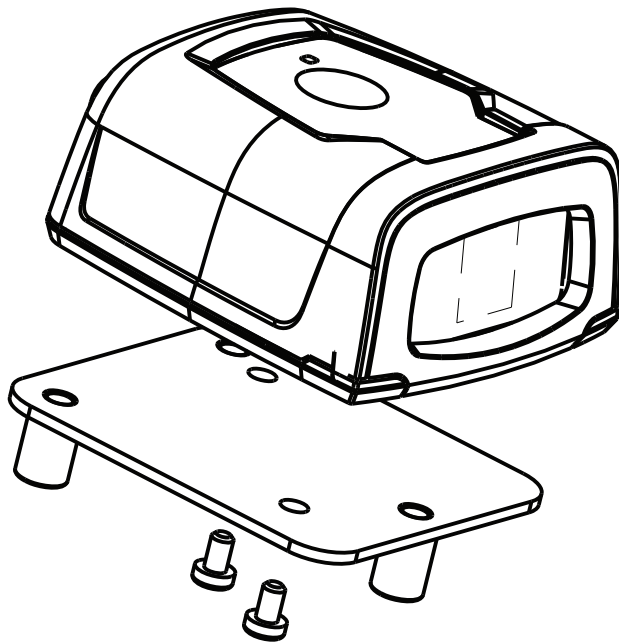

Figure 2-7 *Replacing a Mounted MS320X with the DS457*

Connecting the DS457

USB Host Connection

1. Plug the 9-pin D-connector with the end marked **SCANNER** into the DS457.
2. If using an external switch and applicable host cable, plug the trigger cable into the female stereo connector on the flying lead of the 9-pin D-connector. See [Figure 2-10 on page 2-10](#) for connector pins.
3. Plug the host connector into the appropriate port on the host.
4. Check all connections to ensure they are secure.
5. Program the DS457 using the programming bar codes in this guide.

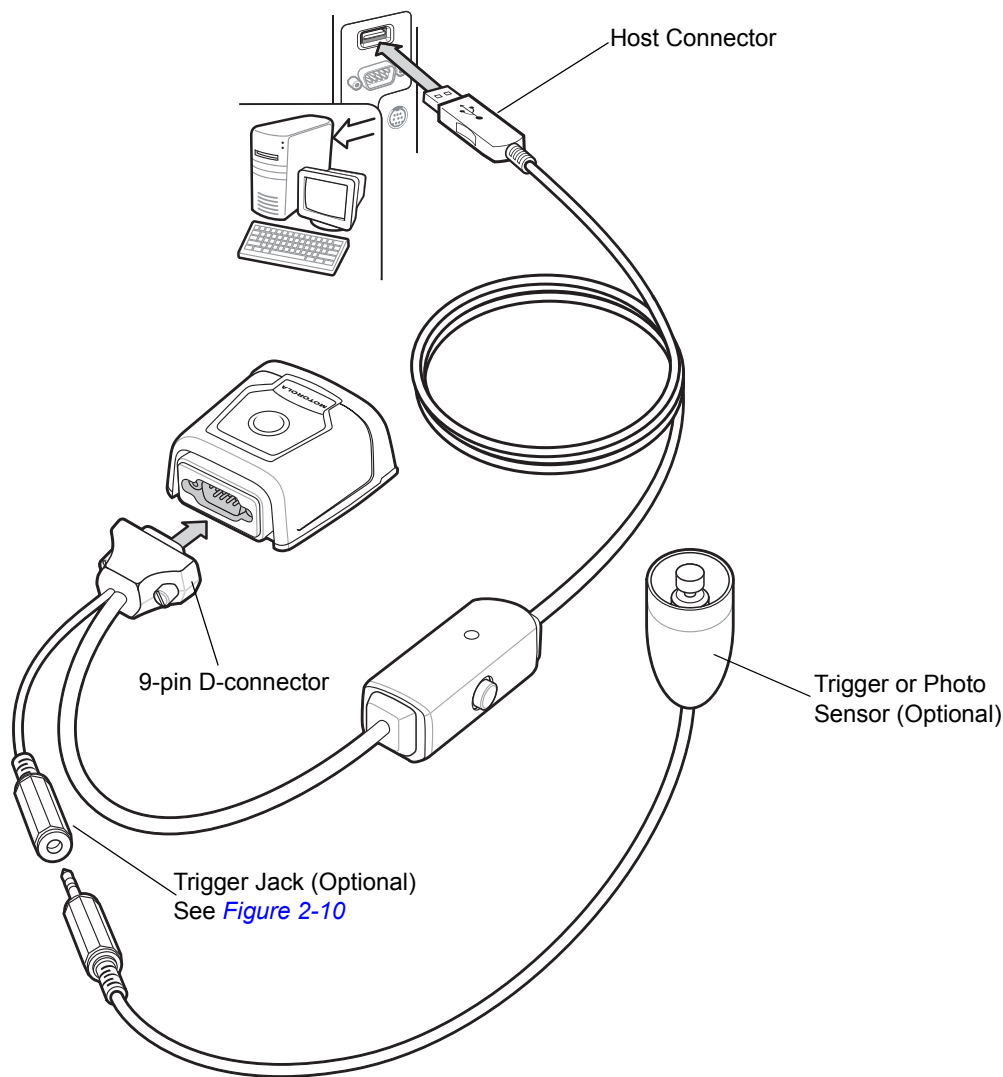

Figure 2-8 USB Connection

Serial Host Connection

1. Plug the 9-pin D-connector with the end marked **SCANNER** into the DS457. See [Serial Interface Cable Connection on page 2-10](#) to determine which cable to use.
2. If using an external switch and applicable host cable, plug the trigger cable into the female stereo connector on the flying lead of the 9-pin D-connector. See [Figure 2-10 on page 2-10](#) for connector pins.
3. Plug the host connector into the appropriate port on the host.
4. Plug the power supply into an AC receptacle, and the output cable from the power supply into the connector near the host end of the interface cable.
5. Check all connections to ensure they are secure.
6. Program the DS457 using the programming bar codes in this guide.

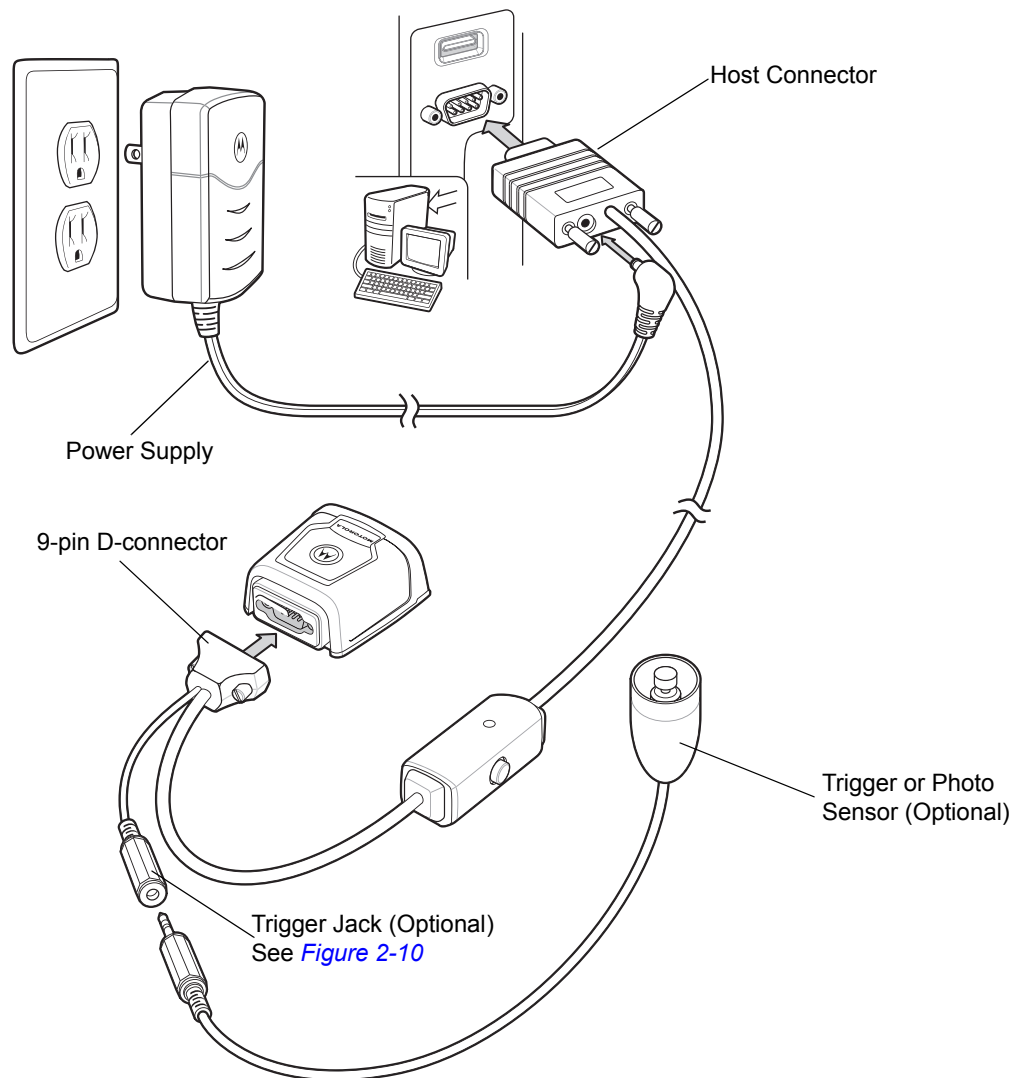

Figure 2-9 Serial Connection

Serial Interface Cable Connection

When connecting via RS-232, identify the type of host system to determine the cable needed. If you are unsure what host system you are using, contact the local Zebra representative.

TTL Level Compatible RS-232 Host Systems

If using a PC, laptop, or POS terminal, the host system most likely has an RS-232 port which is compatible with TTL levels. In this case, use the standard 5V RS-232 cable.

Host Systems Which Require True RS-232 Levels

Some host devices are not compatible with TTL level signals and require true RS-232 levels, such as those in electrically noisy environments and locations with long cable runs. In such installations the DS457 may require a level-shifting cable, such as p/n 25-62186-03R, to interface to this host system.

Failure to use the appropriate cable can impact the imager's ability to reliably communicate with the host under some conditions.

Trigger Jack Connector Pins

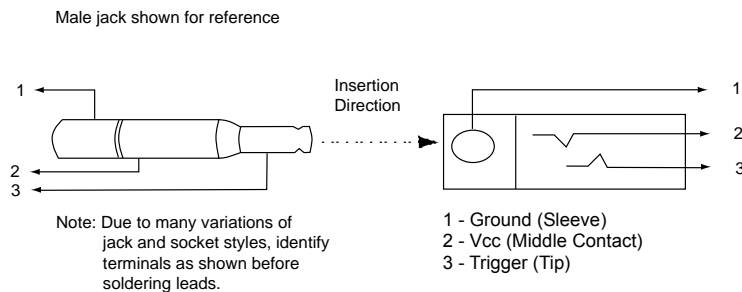

Figure 2-10 *Trigger Jack Connector Pins*

Location and Positioning

The location and positioning guidelines do not consider unique application characteristics. Zebra recommends that an opto-mechanical engineer perform an opto-mechanical analysis prior to integration.



NOTE Integrate the imager in an environment no more extreme than the product's specification, where the imager will not exceed its temperature range. For instance, do not mount the imager onto or next to a large heat source. When placing the imager with another device, ensure there is proper convection or venting for heat. Follow these suggestions to ensure product longevity, warranty, and overall satisfaction with the imager.

Embedded Applications Requiring a Window

Use the following guidelines for applications that require a window in front of the DS457.



NOTE Zebra does not recommend placing an exit window in front of the DS457; however, the following information is provided for applications that require such a window.

Window Material



NOTE Consider the following window placement and material recommendations if mounting the DS457 within a product with its own window.

Many window materials that look perfectly clear can contain stresses and distortions that can reduce imager performance. For this reason, Zebra highly recommends optical glass or cell-cast acrylic. Following is a description of acrylic and CR-39, another popular window material. [Table 2-1](#) outlines the suggested window properties.



CAUTION Consult an opto-mechanical engineer to recommend an appropriate window material and to determine if coatings are appropriate for the specific application.



NOTE Do not use polycarbonate material.

Acrylic (PMMA)

When fabricated by cell-casting, acrylic has very good optical quality and low initial cost. However, protect the surface from the environment as acrylic is susceptible to attack by chemicals, mechanical stresses, and UV light. Acrylic has reasonably good impact resistance and can be ultrasonically welded.

CR-39 (ADC)

CR-39 is a thermal-setting plastic produced by the cell-casting process, and is commonly used in plastic eye glasses lenses. CR-39 has excellent chemical and environmental resistance, including good surface hardness. Typically it does not require hard-coating, but can be hard coated for severe environments. CR-39 has reasonably good impact resistance and cannot be ultrasonically welded.

Chemically Tempered Float Glass

Glass is a hard material which provides excellent scratch and abrasion resistance. However, unannealed glass is brittle. Increasing flexibility strength with minimal optical distortion requires chemical tempering. Glass cannot be ultrasonically welded and is difficult to cut into odd shapes.

Table 2-1 *Suggested Window Properties*

Property	Description
Material	Clear cell-cast acrylic.
Spectral Transmission	85% minimum at 400 - 700 nm.
Thickness	0.059 ± 0.005
Wavefront Distortion (transmission)	0.2 wavelengths peak-to-valley maximum over any 0.08 in. diameter within the clear aperture.
Clear Aperture	To extend to within 0.04 in. of the edges all around.
Surface Quality	60-20 scratch/dig

Window Coatings

[Table 2-3](#) lists some exit window manufacturers and anti-reflection coaters.

Anti-Reflection Coatings

Anti-reflection coatings can be used to achieve maximum working range and to improve the range of acceptable window positions. However, they are expensive. AR coatings also have very poor abrasion and scratch resistance, making only single-side AR coating practical (the AR coated side of the window faces the interior of the imager).

Polysiloxane Coating

Apply polysiloxane type coatings to plastic surfaces to improve the surface resistance to both scratch and abrasion. Typically, you apply these by dipping, then air-drying in an oven with filtered hot air.

Table 2-2 *Taber Test Results on Common Exit Window Materials*

Sample	Haze 100 cycles	Haze 500 cycles	Abrasion Resistance
Chemically Tempered Float Glass	1.20%	1.50%	Best
PMMA with Polysiloxane Hardcoat	3%	10%	
ADC	5%	30%	
PMMA	30%		Worst

*** All measurements use a 100 gram load and CS-10F abraser.**

Table 2-3 *Window Manufacturers and Coaters*

Company	Discipline	Specifics
Evaporated Coatings, Inc. 2365 Maryland Road Willow Grove, PA 19090 (215) 659-3080	Anti-reflection coater	Acrylic window supplier Anti-reflection coater
Fosta-Tek Optics, Inc. 320 Hamilton Street Leominster, MA 01453 (978) 534-6511	Cell-caster, hard coater, laser cutter	CR39 exit window manufacturer
Optical Polymers Int. (OPI) 110 West Main Street Milford, CT 06460 (203) 882-9093	CR-39 cell-caster, coater, laser cutter	CR39 exit window manufacturer
Polycast 70 Carlisle Place Stamford, CT 06902 (800) 243-9002	Acrylic cell-caster, hard coater, laser cutter	Acrylic exit window manufacturer
TSP 2009 Glen Parkway Batavia, OH 45103 (800) 277-9778	Acrylic cell-caster, coater, laser cutter	Acrylic exit window manufacturer

Embedded Window Angle and Position

If you are placing a window between the DS457 and the target, observe the following guidelines:

- **Window Clear Opening** - Make the clear opening of the window large enough so that the entire imager clear aperture passes through the window. Cutting off any part of the clear aperture can degrade decode range performance. Ensure that window placement relative to the DS457 accounts for tolerances on all parts involved in that assembly.
- **Window Angle** - Minimum window tilt is indicated in [Table 2-4 on page 2-15](#). Further tilting the window is acceptable and decreases the possibility of a secondary reflection from that window degrading the imager's performance.
- **Minimum Window Distance** - 5 mm.
- **Optical Working Range** - Adding a window can reduce the working range of the imager since there is a signal loss when passing through window material. To minimize this reduction, use a special coating described in [Window Coatings on page 2-12](#). To understand the difference, test the imager in the desired orientation and see if the difference affects imager performance.

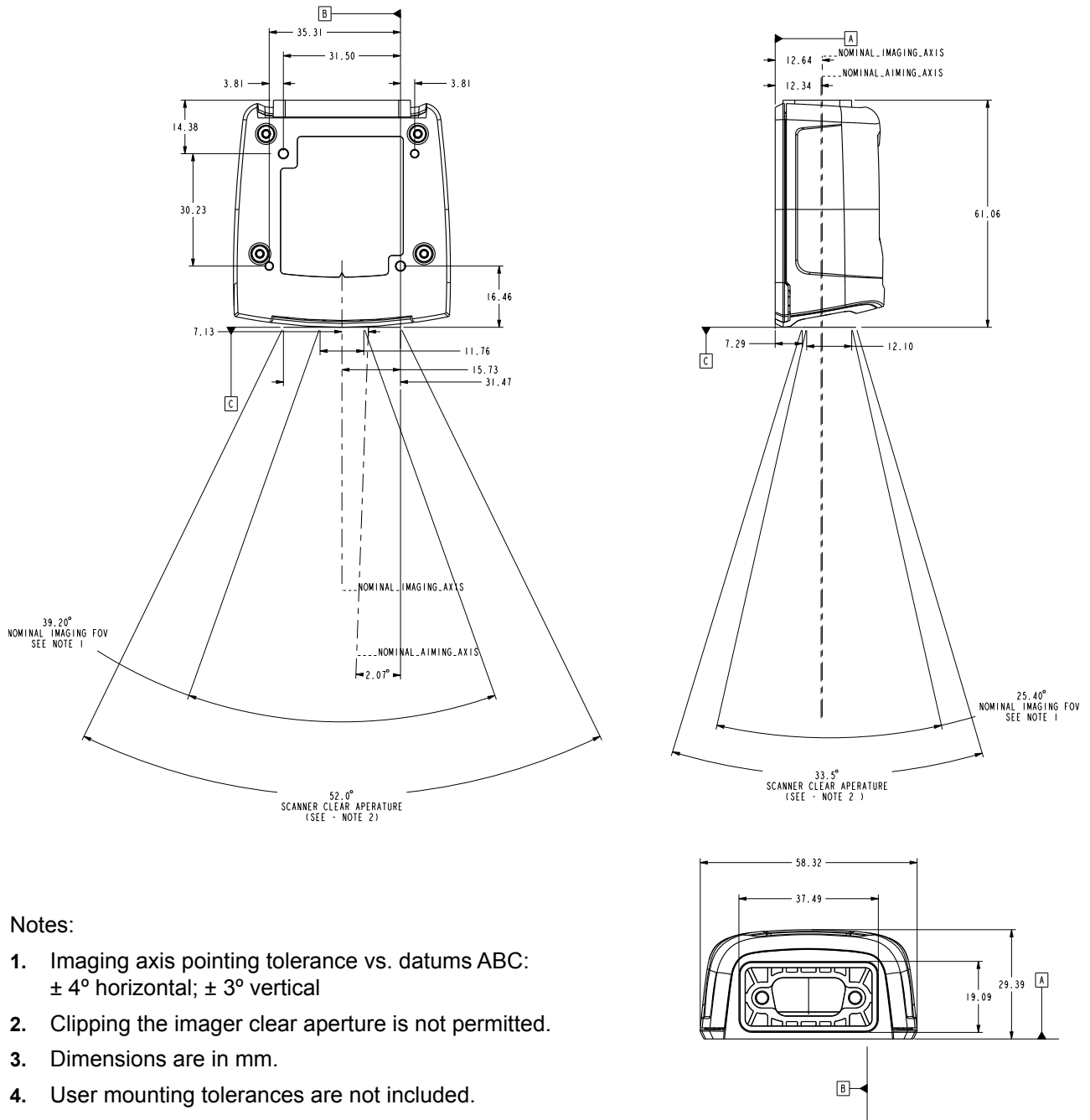

Figure 2-11 DS457 Optical Path and Exit Window

Recommended Exit Window Information

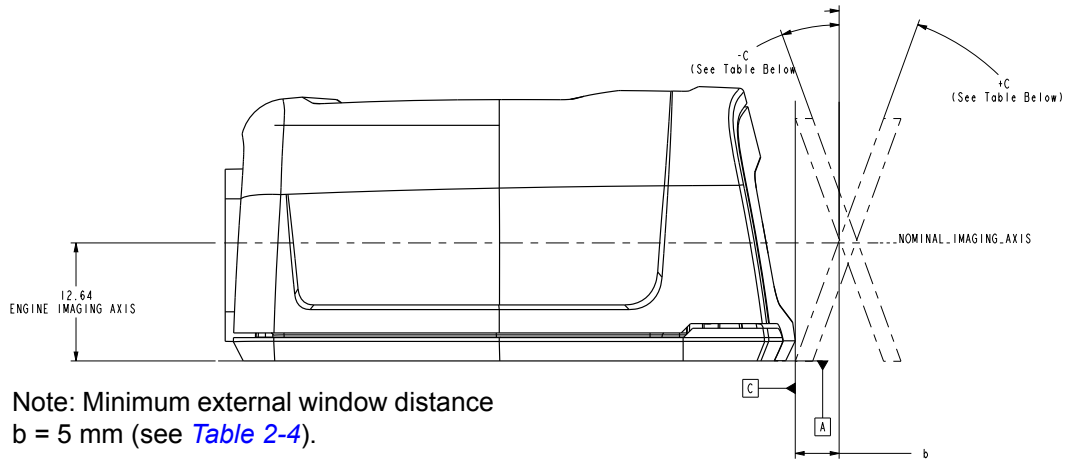

Figure 2-12 Window Distances

Table 2-4 Recommended Exit Window Information - Tilted Window

External Window Specification	Minimum Window Angle
Non-coated, minimum window positive tilt (+c)	31°
Non-coated, minimum window negative tilt (-c)	31°
AR coated, one side, minimum window positive tilt (+c)	26°
AR coated, one side, minimum window negative tilt (-c)	27°
AR coated, two sides, minimum window positive tilt (+c)	23°
AR coated, two sides, minimum window negative tilt (-c)	17°

Exit Window Notes

- Integration tolerances are not included.
- Ensure the window size is large enough to cover the engine clear aperture specified in [Figure 2-11](#) plus mounting tolerances of the window relative to the engine.

Accessories

Zebra offers the following accessories for the imager. Refer to Solution Builder (ordering guide).

Table 2-5 DS457 Imager Accessories

Accessory	Part Number
Power Supplies (RS-232)*	
5 VDC 850 mA; US, Canada, Mexico, Japan, Taiwan	PWRS-14000-253R
5 VDC 850 mA; EU, UK, EMEA, Russia, South Africa	PWRS-14000-256R
5 VDC 850 mA; China	PWRS-14000-257R
5 VDC 850 mA; Australia, Hong Kong, New Zealand	PWRS-14000-258R
5 VDC 850 mA; Argentina, Uruguay	PWRS-14000-259R
RS-232	
9-Pin female (DB9) with straight connector, 6 ft, with trigger jack, no beeper	25-13227-03R
9-Pin female (DB9) with straight connector, 6 ft, with trigger jack and beeper	25-13228-03R
9-Pin female (DB9) with straight connector, 6 ft, no trigger jack or beeper	25-58918-02R
9-Pin female (DB9) coiled, 9 ft, no trigger jack or beeper	25-58918-03R
9-Pin female (DB9) with straight connector, 6 ft, with trigger jack and no hardware handshaking	25-63736-02R
TTL RS-232 to true RS-232 conversion cable, low profile connector	25-62186-03R
USB	
9-Pin female (DB9) with straight connector, 6 ft, with trigger jack and beeper	25-58925-02R
9-Pin female (DB9) with straight connector, 6 ft, no trigger jack or beeper	25-58926-04R
9-Pin female (DB9), 18 in, no trigger jack or beeper (for kiosks)	25-58926-05R
9-Pin female (DB9), coiled, 9 ft, no trigger jack or beeper	25-58926-06R
Optional Accessories	
Push button trigger cable	25-04950-01R
Photo sensor trigger cable (retroreflective, IR 850nm, 7 foot range)	25-13176-01R
Gooseneck stand (twilight black)	20-60136-02R
POS wall/counter mount	KT-145344-01
MS320x to DS457 conversion mounting bracket	KT-152342-01

***Standalone power supply is not used for USB hosts.**

Simple Serial Interface Software Developer's Kit (SSI SDK)

The SSI Software Developer's Kit, available on Zebra's website, provides the software tools used to integrate and communicate with the DS457 imagers via RS-232, including:

- Sample Windows® program with source code
- DLL with source code for building user applications
- ActiveX component (including help file) for easy integration into VisualBasic programs
- Simple Serial Interface documentation.

With over 70 programmable parameters, you can configure DS457 imagers using bar code menus, or through the serial interface using Zebra's Simple Serial Interface protocol.

For Windows®, DOS, and embedded system environments, this enables you to take full advantage of the imager's features and obtain maximum performance.

To download the SDK, go to: <http://www.zebra.com/support>.

Zebra SNAPI Software Developer's Kit

The Symbol Native Application Programming Interface Software Development Kit (SNAPI SDK) facilitates communicate with SNAPI-based Zebra scanners over USB, providing the following features:

- Bar code capture and decode
- Image and video capture
- Electronic scanner configuration and software update
- Reference sample application in Microsoft Visual C#® .NET.

To download the SDK, go to: <http://www.zebra.com/support>.

CHAPTER 3 IMAGING

Overview

This chapter provides information on aiming, illumination, data capture, beeper and decode LED feedback, supported symbologies, and operating modes.

Imaging System

Aiming Pattern

A 655 nm laser and a pattern forming element generate a laser aiming pattern which represents the imager's field of view throughout its entire depth of field. The pattern's center dot indicates the center of the field of view.

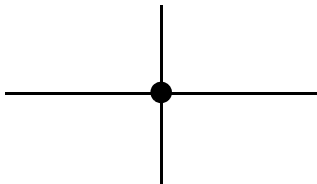

Figure 3-1 *Aiming Pattern*

The bright center spot provides visibility for aiming in sunlight and other bright light applications. The aiming pattern indicates the field of view for capturing images. The ends of the horizontal and vertical lines represent the midpoints of the sides of an imaginary box outlining the capture field.

Aiming Error

The aiming pattern is rotated by 2° relative to the imaging axis in the horizontal plane to minimize parallax between the aiming axis and the imaging axis at 190 mm (7.5 in.) from the imager.

Aiming Control

The DS457 can capture images with both the aiming subsystem turned on during exposure (the image of the aiming pattern is visible in the digital image) or off. If the aiming system is turned off during exposure, brightness of the aiming pattern decreases as exposure increases.

Illumination System

The illumination system consists of two high-output, red LEDs (625 nm) and a sophisticated drive system that allows image capture and decoding throughout a full range of lighting conditions (total darkness to full sunlight).

Illumination Control

The DS457 can capture images with the illumination subsystem turned on or off, accommodating images that are close to the wavelength of the illumination. For example, since the imager uses red LED illumination, it may be desirable to shut off the illumination when capturing an image printed in red ink.

It is recommended to turn off LED illumination and provide minimum 30 fcd ambient light on the document surface when taking images of documents. Even a small amount of dust or fingerprints on the imager window can scatter the LED illumination and create glare in the image. The glare reduces quality of document images but does not affect bar code reading.

Frame Rate Control

The DS457 outputs images at 60 frames per second by default. When capturing images, use lower frame rates to increase image brightness. The aiming pattern and illumination appear to blink when the frame rate is 30 fps or lower.

Capturing Data

When scanning, the imager projects a red laser aiming pattern which allows positioning the bar code within its field of view. See [Decode Zones on page 4-6](#) for the proper distance to achieve between the imager and a bar code. The imager turns on its red LEDs to illuminate the target bar code.

In Presentation Mode (default), when the DS457 detects an object in its field of view, it automatically triggers and displays the aiming pattern. In triggered mode, press the trigger button on top of the imager to display the aiming pattern.

To scan a bar code, center the symbol in any orientation within the aiming pattern. Be sure the entire symbol is within the rectangular area formed by the cross pattern.

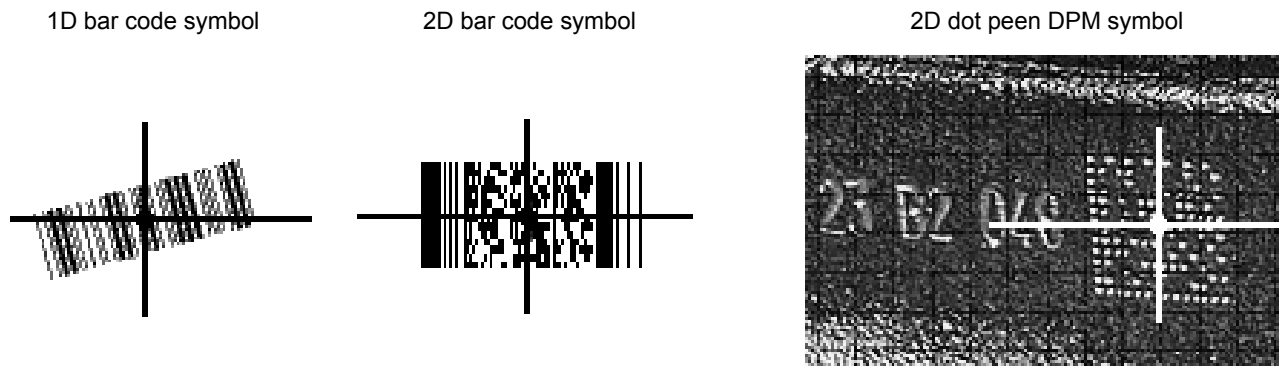

Figure 3-2 Scanning Orientation with Imager Aiming Pattern

The imager can also read a bar code presented within the aiming pattern but not centered. The top examples in [Figure 3-3](#) show acceptable aiming options, while the bottom examples can not be decoded.

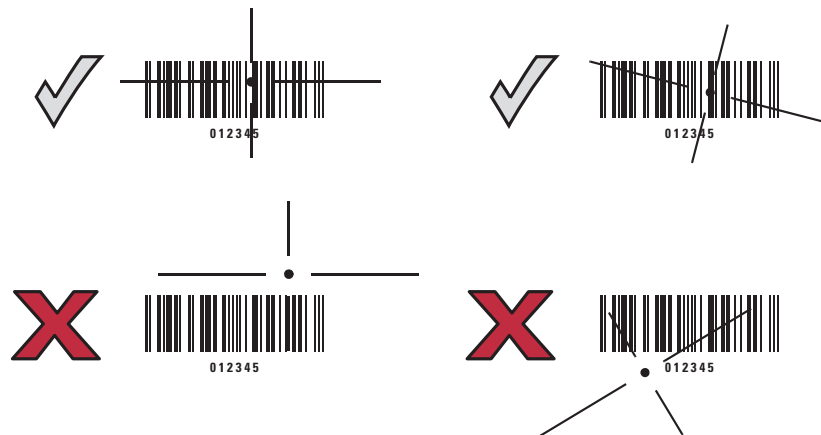

Figure 3-3 Acceptable and Incorrect Aiming

Upon successful decode, the DS457 beeps and its feedback LED turns green.

Beeper and Decode LED Indications

Table 3-1 provides beeper and LED indications related to certain events. The LED illuminates red to indicate that the imager has power. SSI events are also listed.

Table 3-1 *User Interface Indications*

Description	Indication		SSI Event
	Beeper	Power/Decode LED	
Trigger pull	No sound	Red	TRIGGER_PULLED
No decode			NODECODE_MSG
Wakeup			WAKEUP
Video is off			VIDEO_OFF
Video is on			VIDEO_ON
Decode	Middle Tone	Flash of green	DECODE
Snapshot started	Low Tone	Blinking green	SNAPSHOT_START
Snapshot is complete	Low Tone	Red	SNAPSHOT_COMPLETE
Bootup	Low Tone, Middle Tone, High Tone	Red	BOOTUP
Transmission error	Four Low Tones	Red	TRANSMIT_ERROR
Entry error	Low Tone, High Tone	Flash of green	ENTRY_ERROR
Defaults set	High Tone, Low Tone, High Tone, Low Tone	Flash of green	DEFAULTS_SET
Parameter entered			PARAM_ENTERED
Number entry expected	High Tone, Low Tone	Flash of green	NUMBER_EXPECTED

Supported Symbologies

The following bar code types are supported and can be individually enabled or disabled:

1D Symbologies

UPC/EAN
 Bookland EAN
 UCC Coupon Code
 ISSN EAN
 Code 128
 GS1-128
 ISBT 128
 Code 39
 Trioptic Code 39
 Code 32
 Code 93
 Code 11
 Interleaved 2 of 5
 Discrete 2 of 5
 Codabar
 MSI
 Chinese 2 of 5
 Matrix 2 of 5
 Korean 3 of 5
 Inverse 1D
 GS1 DataBar
 Composite Codes

2D Symbologies

PDF417
 MicroPDF417
 Data Matrix
 Data Matrix Inverse
 Maxicode
 QR Code
 MicroQR
 QR Inverse
 Aztec
 Aztec Inverse

Postal Codes

US Postnet
 US Planet
 UK Postal
 Japan Postal
 Australian Postal
 Netherlands KIX Code
 USPS 4CB/One Code/Intelligent Mail
 UPU FICS Postal

Operating Modes

The DS457 supports the following operating modes. See [Operational Modes on page 7-4](#) for information on changing between modes.

- Decode (default mode) - for decoding a bar code
- Snapshot - for capturing an image
- Snapshot with Viewfinder Mode - provides a video of the subject until a snapshot of the image is captured.
- Video - provides a video of the subject

CHAPTER 4 SPECIFICATIONS

Electrical Interface

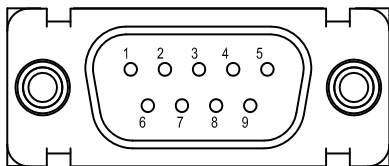

Figure 4-1 DS457 Connector

Table 4-1 lists the pin functions of the DS457 interface.

Table 4-1 DS457 USB and Serial Electrical Interface

USB Interface		Serial Interface	
Pin No.	Pin Name	Pin No.	Pin Name
1	Trigger	1	Trigger
2	NC	2	TXD Output TTL Only
3	USB +	3	RXD Input TTL Only
4	Connect to Pin 8	4	NC
5	Ground	5	Ground
6	+5V Power	6	+5V Power
7	USB -	7	CTS Input TTL Only
8	Connect to Pin 4	8	RTS Output TTL Only
9	Beeper/Download	9	Beeper/Download

NC = No Connect (do not connect this pin)

Dimension Drawings

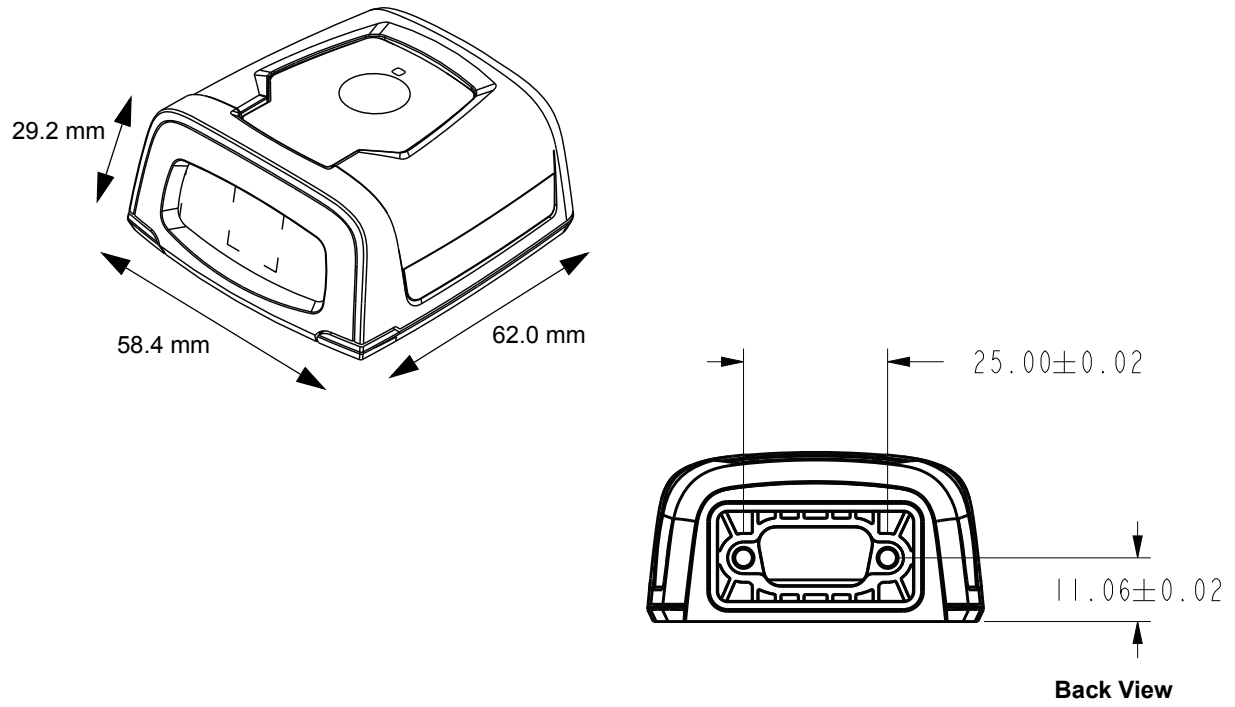

Figure 4-2 DS457 Dimension Drawings

DS457 Imager Technical Specifications

Table 4-2 DS457 Technical Specifications at 23° C

Item	Description
Performance Characteristics	
Sensor Resolution	752 x 480 pixels
Field of View	DS457-SR/DL: 39.6° horizontal, 25.7° vertical DS457-HD/DP: 38.4° horizontal, 24.9° vertical
Pitch/Skew/Roll Tolerance	± 60° / ± 60° / 360° (see Figure 4-3 on page 4-5)
Focal Distance from Front of Imager Housing	DS457-SR/DL: 4.7 in. DS457-HD/DP: 2.3 in.
Aiming Element (VLD)	655 nm ± 10 nm
Illumination Element	625 nm ± 5 nm (LED)
Minimum Print Contrast	25% absolute dark/light reflectance
User Environment	
Power Requirements	
Supply Voltage	5.00 V ± 0.5 V
Low Power / Suspend Current Draw	2.5 mA (typical)
Idle Current	160 mA (typical)
Operating Current (scan/decode session)	280 mA (average)
Peak Current	450 mA
Ambient Light Immunity	Total darkness to 9,000 ft. candles (96,900 lux)
Humidity	
Operating	95% RH, non-condensing at 50° C
Storage	85% RH, non-condensing at 70° C
Drop Rating	Unit functions normally after multiple 30 in (76 cm) drops to tile over concrete
Temperature	
Operating	-4° to 122° F (-20° to 50° C)*
Storage	-40° to 158° F (-40° to 70° C)
	* Above 45°C the laser aimer is disabled. In high temperature environments the DS457 safeguards the laser from overheating by monitoring the internal system temperature. For this reason, if Time Delay to Presentation Idle Mode is set to a high value and the aiming pattern remains on for an extended period of time while in presentation mode, the imager may temporarily shut off the aiming pattern.

Note: Environmental and/or tolerance parameters are not cumulative. Perform a thermal analysis if the application is subject to an extreme temperature environment.

Table 4-2 DS457 Technical Specifications at 23° C (Continued)

Item	Description
Dimensions	1.15 in. (29.2 mm) H x 2.30 in. (58.4 mm) W x 2.44 in. (62.0 mm) D
Weight	3.9 oz. (111.0 grams)
Interface	9-pin male D-sub supports USB (full speed) and TTL level RS-232 with RTS and CTS

Note: Environmental and/or tolerance parameters are not cumulative. Perform a thermal analysis if the application is subject to an extreme temperature environment.

Skew, Pitch and Roll

Measured on a 20 mil Code 39 symbol at a distance of 10 inches. Tolerance is reduced at extreme ends of the working range.

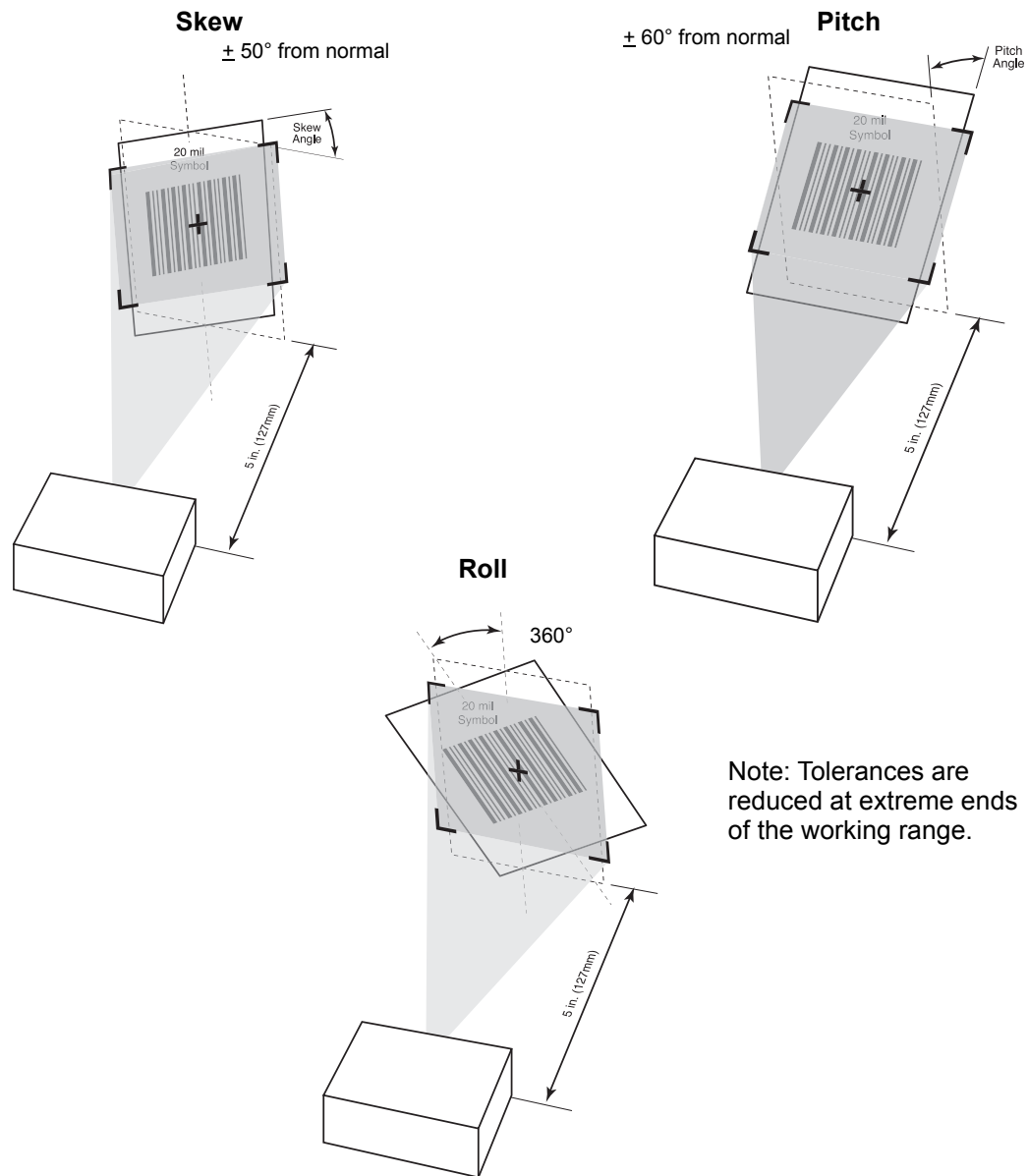

Figure 4-3 Skew, Pitch and Roll

Decode Zones

DS457-SR/DL

Figure 4-4 shows the decode zone for the DS457-SR/DL. Typical values appear. Table 4-3 lists the typical and guaranteed distances for selected bar code densities. The minimum element width (or “symbol density”) is the width in mils of the narrowest element (bar or space) in the symbol.

Note: Typical performance at 73°F (23°C)
on high quality symbols.

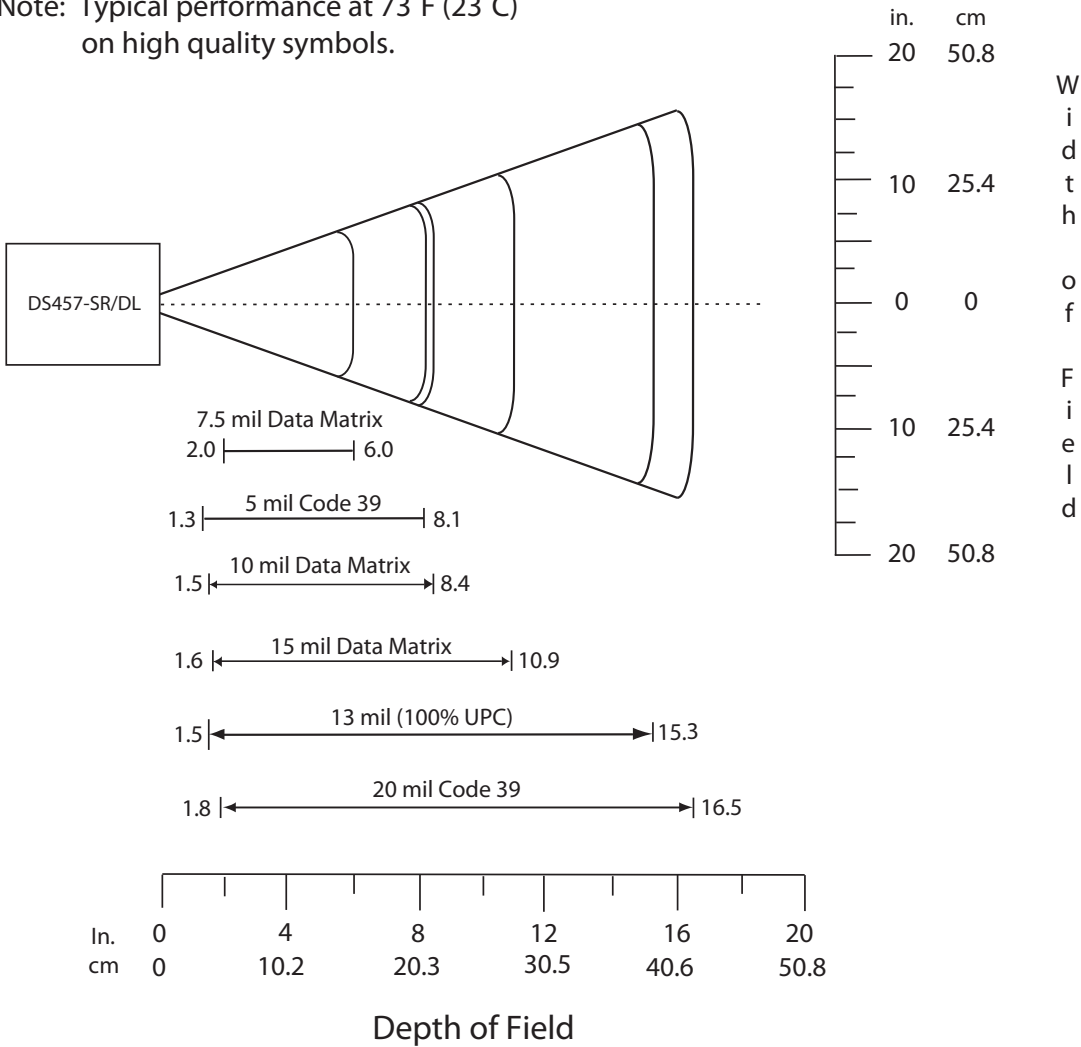

Figure 4-4 DS457-SR/DL Decode Zone - 1D and Data Matrix Symbols

Note: Typical performance at 73°F (23°C)
on high quality symbols.

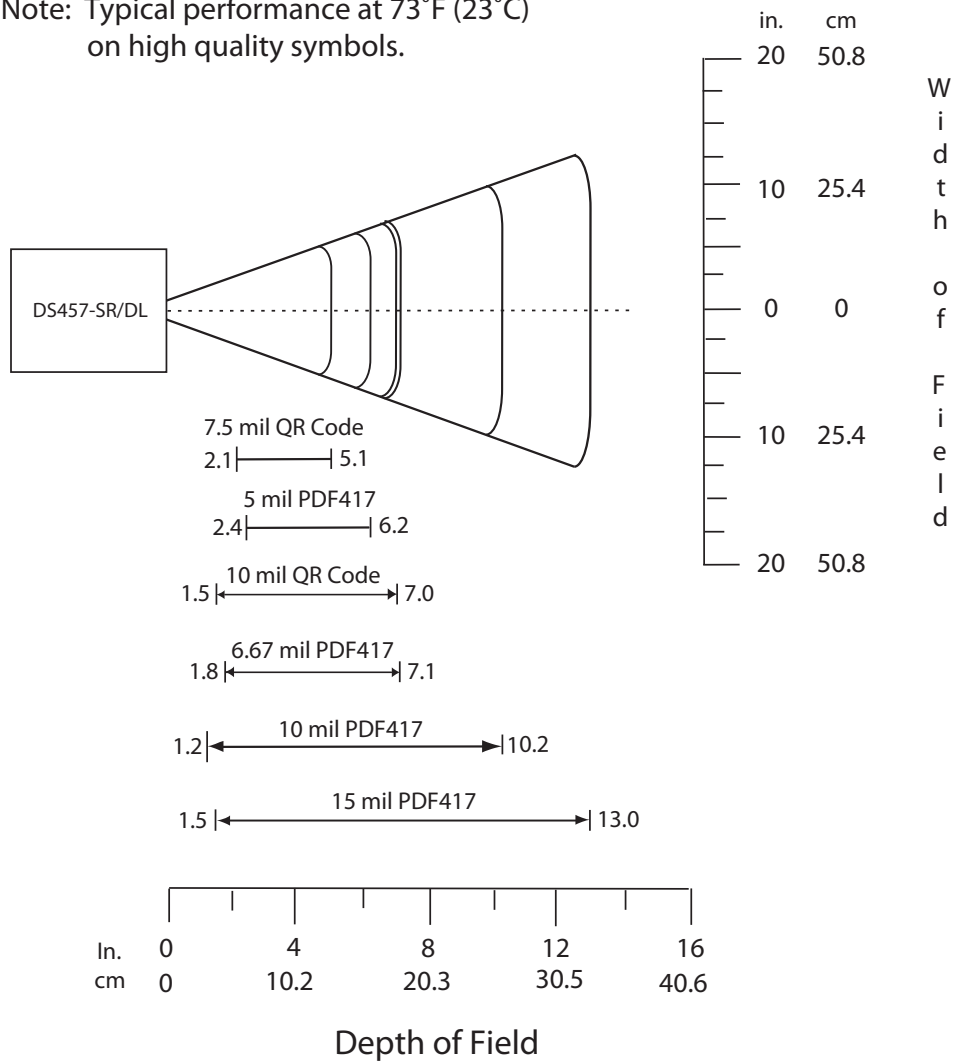

Figure 4-5 DS457-SR/DL Decode Zone - QR Code and PDF417 Symbols

Table 4-3 DS457-SR/DL Decode Distances (Presentation Mode with No Motion Enhancement)

Symbol Density/ Bar Code Type	Typical Working Ranges		Guaranteed Working Ranges	
	Near	Far	Near	Far
5.0 mil Code 39	1.3 in 3.30 cm	8.1 in 20.57 cm	1.6 in 4.06 cm	6.3 in 16.00 cm
20 mil Code 39	1.8 in 4.57 cm	16.5 in 41.91 cm	Note 1	11.6 in 29.46 cm
13 mil 100% UPC	1.5 in 3.81 cm	15.3 in 38.86 cm	2.1 in 5.33 cm	9.5 in 24.13 cm
7.5 mil Data Matrix	2.0 in 5.08 cm	6.0 in 15.24 cm	N/A	N/A
10 mil Data Matrix	1.5 in 3.81 cm	8.4 in 21.34 cm	N/A	N/A
15 mil Data Matrix	1.6 in 4.06 cm	10.9 in 27.69 cm	N/A	N/A
7.5 mil QR Code	2.1 in 5.33 cm	5.1 in 12.95 cm	N/A	N/A
10 mil QR Code	1.5 in 3.81 cm	7.0 in 17.78 cm	N/A	N/A
5.0 mil PDF417	2.4 in 6.10 cm	6.2 in 15.75 cm	3.1 in 7.87 cm	3.5 in 8.89 cm
6.67 mil PDF417	1.8 in 4.57 cm	7.1 in 18.03 cm	2.1 in 5.33 cm	5.8 in 14.73 cm
10 mil PDF417	1.2 in 3.05 cm	10.2 in 25.91 cm	Note 1	7.6 in 19.30 cm
15 mil PDF417	1.5 in 3.81 cm	13.0 in 33.02 cm	Note 1	10.1 in 25.65 cm

Notes:

1. Near distances are field-of-view (FOV) limited.
2. Contrast is measured as Mean Reflective Difference (MRD) at 670 nm.
3. Working range specifications at temperature = 23°C, pitch=18°, roll=0°, skew=0°, photographic quality, humidity 45-70% RH.
4. Enabling Motion Enhancement reduces decode ranges.

DS457-HD/DP

Figure 4-6 shows the decode zone for the DS457-HD/DP. Typical values appear. Table 4-4 lists the typical and guaranteed distances for selected bar code densities. The minimum element width (or “symbol density”) is the width in mils of the narrowest element (bar or space) in the symbol.

Note: Typical performance at 73°F (23°C)
on high quality symbols.

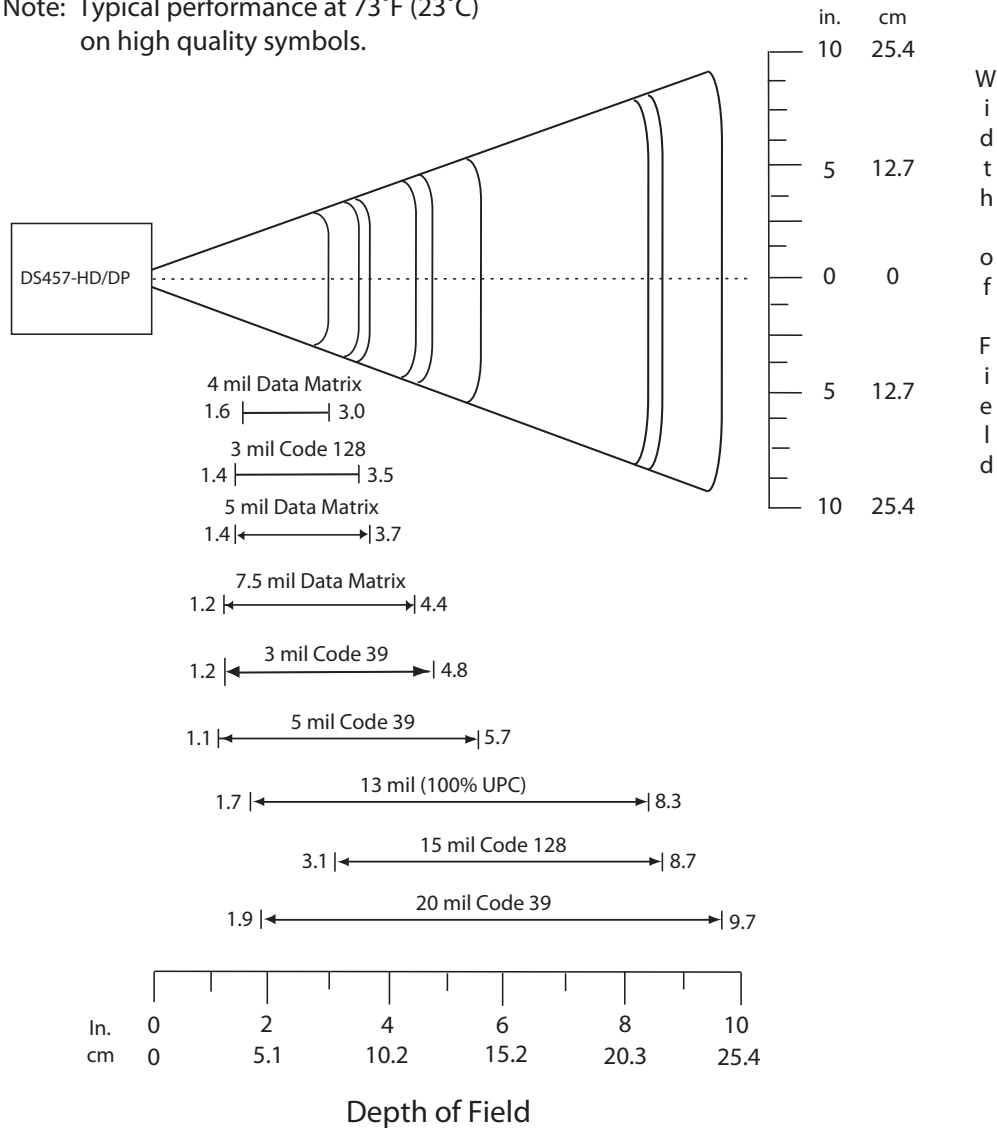

Figure 4-6 DS457-HD/DP Decode Zone - 1D and Data Matrix Symbols

Note: Typical performance at 73°F (23°C)
on high quality symbols.

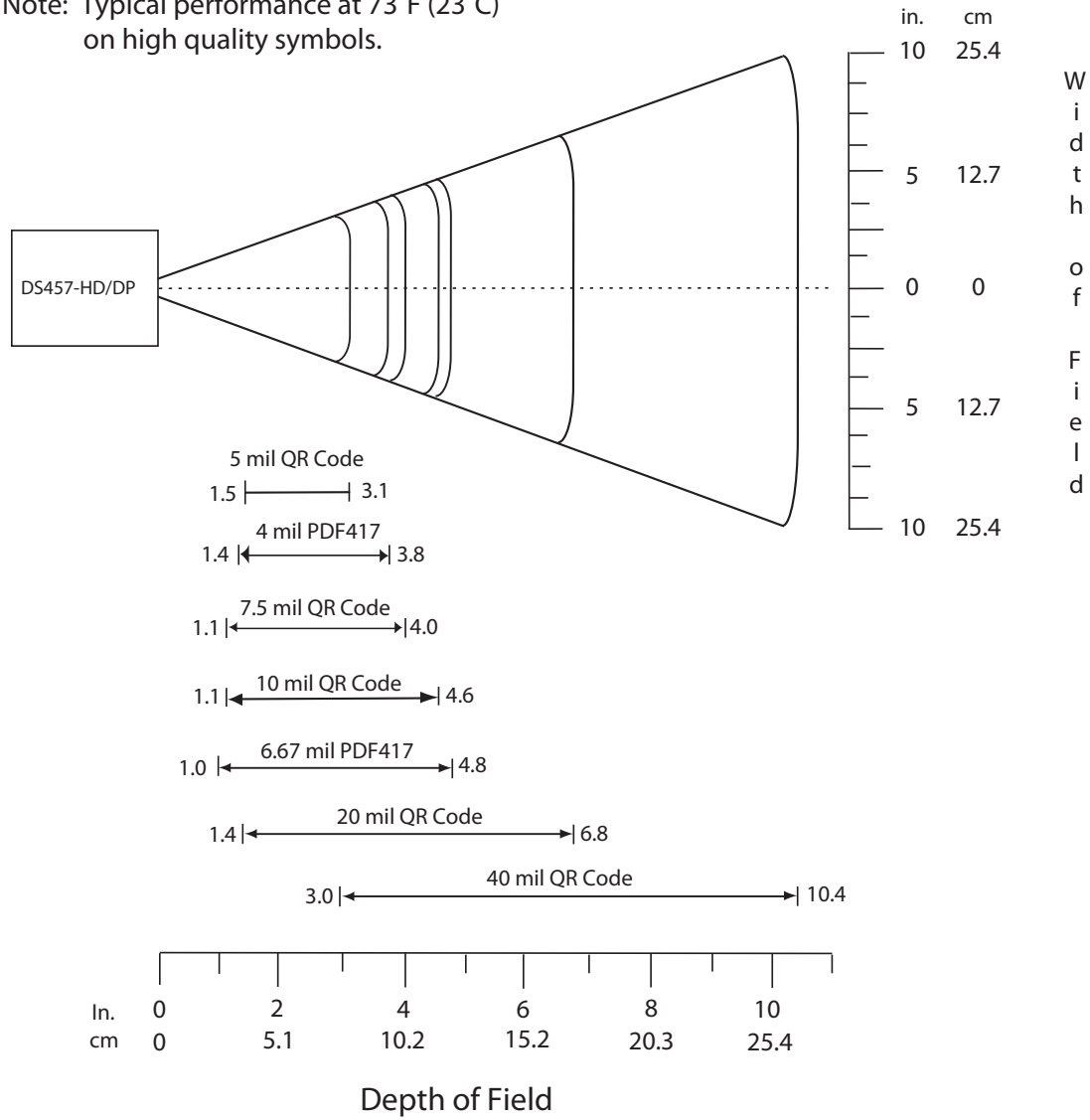

Figure 4-7 DS457-HD/DP Decode Zone - QR Code and PDF417 Symbols

Table 4-4 DS457-HD/DP Decode Distances (Presentation Mode with No Motion Enhancement)

Symbol Density/ Bar Code Type	Typical Working Ranges		Guaranteed Working Ranges	
	Near	Far	Near	Far
3.0 mil Code 39	1.2 in 3.05 cm	4.8 in 12.19 cm	1.4 in 3.56 cm	3.0 in 7.62 cm
5.0 mil Code 39	1.1 in 2.79 cm	5.7 in 14.48 cm	Note 1	4.1 in 10.41 cm
20 mil Code 39	1.9 in 4.83 cm	9.7 in 24.64 cm	Note 1	9.3 in 23.62 cm
3.0 mil Code 128	1.4 in 3.56 cm	3.5 in 8.89 cm	N/A	N/A
15.0 mil Code 128	3.1 in 7.87 cm	8.7 in 22.10 cm	N/A	N/A
13 mil 100% UPC	1.7 in 4.32 cm	8.3 in 21.08 cm	2.1 in 5.33 cm	5.7 in 14.48 cm
4 mil Data Matrix	1.6 in 4.06 cm	3.0 in 7.62 cm	N/A	N/A
5 mil Data Matrix	1.4 in 3.56 cm	3.7 in 9.40 cm	N/A	N/A
7.5 mil Data Matrix	1.2 in 3.05 cm	4.4 in 11.18 cm	N/A	N/A
5 mil QR Code	1.5 in 3.81 cm	3.1 in 7.87 cm	N/A	N/A
7.5 mil QR Code	1.1 in 2.79 cm	4.0 in 10.16 cm	N/A	N/A
10 mil QR Code	1.1 in 2.79 cm	4.6 in 11.68 cm	N/A	N/A
20 mil QR Code	1.4 in 3.56 cm	6.8 in 17.27 cm	N/A	N/A

Notes:**1. Near distances are FOV limited.****2. Contrast is measured as Mean Reflective Difference (MRD) at 670 nm.****3. Working range specifications at temperature = 23°C, pitch=18°, roll=0°, skew=0°, photographic quality, humidity 45-70% RH.****4. Enabling Motion Enhancement reduces decode ranges.**

Table 4-4 DS457-HD/DP Decode Distances (Presentation Mode with No Motion Enhancement) (Continued)

Symbol Density/ Bar Code Type	Typical Working Ranges		Guaranteed Working Ranges	
	Near	Far	Near	Far
40 mil QR Code	3.0 in 7.62 cm	10.4 in 26.42 cm	N/A	N/A
4.0 mil PDF417	1.4 in 3.56 cm	3.8 in 9.65 cm	1.6 in 4.06 cm	2.7 in 6.86 cm
6.67 mil PDF417	1.0 in 2.54 cm	4.8 in 12.19 cm	1.1 in 2.79 cm	3.6 in 9.14 cm

Notes:

1. Near distances are FOV limited.
2. Contrast is measured as Mean Reflective Difference (MRD) at 670 nm.
3. Working range specifications at temperature = 23°C, pitch=18°, roll=0°, skew=0°, photographic quality, humidity 45-70% RH.
4. Enabling Motion Enhancement reduces decode ranges.

CHAPTER 5 MAINTENANCE & TROUBLESHOOTING

Overview

The chapter provides information on maintenance and troubleshooting.

Maintenance

Clean the imager housing and exit window with a damp cloth and, if necessary, a non-ammonia based detergent. Do not allow any abrasive material to touch the exit window.

Cleaning the Connector

1. Remove the cable connector from the imager.
2. Rub a cotton-tipped applicator dipped in isopropyl alcohol back and forth across the connector pins. Do not leave any cotton residue on the connector.
3. Rub a dry cotton-tipped applicator back and forth across the connector pins.
4. Spray compressed air on the connector area by pointing the tube/nozzle about ½ inch away from the surface.
5. Inspect the area for any grease or dirt and repeat if required.



CAUTION Do not get excess alcohol onto the soft elastomeric gasket since this can compromise the adhesion to the housing and ultimately the gasket's ability to prevent liquids from entering the imager in this area during normal operation.

Troubleshooting

Problem	Possible Cause	Possible Solutions
No red LED or nothing happens during a capture attempt.	No power to the imager.	Check the system power. Confirm that the correct host interface cable is used.
		Connect the power supply.
		Re-connect loose cables.
Imager cannot read the bar code.	Interface/power cables are loose.	Re-connect loose cables.
	Imager is not programmed for the correct bar code type.	Program the imager to read the type of bar code to be decoded.
	Incorrect communication parameters.	Set the correct communication parameters (baud rate, parity, stop bits, etc.)
	Bar code symbol is unreadable.	Ensure the symbol is not defaced. Try capturing similar symbols of the same code type.
Aiming pattern does not appear.	Hot environment.	Remove the imager from the hot environment, and allow it to cool down.
Laser activates, followed by a beep sequence.	Beeper is configured.	See Beeper and Decode LED Indications on page 3-4 for beeper indication descriptions.



NOTE If after performing these checks the symbol still does not decode, contact the distributor or contact Zebra Global Customer Support. See [page xviii](#) for contact information.

CHAPTER 6 USER PREFERENCES

Introduction

This chapter describes each user preference feature and provides the programming bar codes necessary for selecting these features.

Host Selection

The default serial host is SSI and the default USB host is HID Keyboard Emulation, as these host types provide more flexibility during integration when configuring the unit via host command. Selecting other host configurations requires scanning bar code menus and cannot be performed via host programming. See each host chapter for configuration options for each host type.

- ✓ **NOTE** The DS457 automatically switches between USB and serial host interfaces based on the type of cable attached.
- ✓ **NOTE** Selecting one of the [Serial Host Types on page 9-5](#) disables SSI support. To restore SSI support, scan [SSI Host on page 8-9](#).

Phantom Scan Session

The Phantom Scan Session feature places the system into a known state for two seconds immediately after the power-up beep sequence in order to decode a parameter bar code without intervention and regardless of existing settings and mode. This allows you to scan a **Set Defaults** or other parameter bar code without triggering the imager or initiating a host scan session in order to return an unresponsive system to its factory default settings. Aim and illumination are turned off and Phantom Scan exits upon a trigger event, host command, or successful decode.

Changing Default Values

The imager ships with the settings shown in the [Table 6-1 on page 6-3](#) (also see [Appendix A, Standard Default Parameters](#) for all host and miscellaneous defaults). If the default values suit requirements, programming is not necessary.

There are two ways to change a parameter value:

- Scan the appropriate bar codes in this guide. These new values replace the standard default values in memory.
- For SSI and USB SNAPi hosts, send a “parameter send” command from the host system. Hexadecimal parameter numbers appear in this chapter below the parameter title, and options appear in parenthesis beneath the accompanying bar codes. See the *Simple Serial Interface (SSI) Programmer’s Guide* for detailed instructions for changing parameter values using this method.



NOTE Most computer monitors allow scanning the bar codes directly on the screen. When scanning from the screen, be sure to set the document magnification to a level where you can see the bar code clearly, and bars and/or spaces are not merging.

To return all features to default values, scan [*Restore Defaults on page 6-5](#). Throughout the programming bar code menus, asterisks (*) indicate default values.



* Indicates default — ***High Volume** — Feature/Option
(0) — Option decimal value for programming

Scanning Sequence Examples

In most cases, scanning one bar code sets the parameter value. For example, to set the beeper tone to high, scan the **High Frequency** (beeper tone) bar code listed under [Beeper Tone on page 6-9](#). The imager issues a fast warble beep signal and a good decode LED signal, signifying a successful parameter entry.

Other parameters, such as **Decode Session Timeout**, require scanning several bar codes. See these parameter descriptions for this procedure.

Errors While Scanning

Unless otherwise specified, to correct an error during a scanning sequence, just re-scan the correct parameter.

User Preferences Parameter Defaults

[Table 6-1](#) lists defaults for user preferences parameters. To change any parameter value, scan the appropriate bar code(s) provided in the User Preferences section beginning on [page 6-5](#).

✓ **NOTE** See [Appendix A, Standard Default Parameters](#) for all user preferences, hosts, symbologies, and miscellaneous default parameters.

Table 6-1 User Preferences Default Table

Parameter	Parameter Number	SSI Number	Default	Page Number
User Preferences				
Set Default Parameter			Restore Defaults	6-5
Parameter Scanning	236	ECh	Enable	6-6
User Parameter Pass Through	625	F1h 71h	Disable	6-7
Beep After Good Decode	56	38h	Enable	6-8
Beeper Tone	145	91h	Medium	6-9
Beeper Volume	140	8Ch	High	6-10
Suppress Power-up Beeps	721	F1h D1h	Do not suppress	6-10
Trigger Mode	138	8Ah	Presentation	6-11
Presentation Performance Mode	650	F1h 8Ah	Standard	6-12
Time Delay to Presentation Idle Mode	663	F1h 97h	1 Minute	6-13
Time Delay to Presentation Sleep Mode	662	F1h 96h	1 Minute	6-15
Power Mode	128	80h	Low Power	6-17
Time Delay to Low Power Mode	146	92h	1.0 Sec	6-17
Picklist Mode	402	F0h 92h	Disabled Always	6-19
Decode Session Timeout	136	88h	9.9 Sec	6-19
Timeout Between Decodes, Same Symbol	137	89h	0.6 Sec	6-20
Continuous Bar Code Read	649	F1h 89h	Disable	6-20
Unique Bar Code Reporting	723	F1h D3h	Enable	6-21
Mirrored Image	624	F1h 70h	Disable	6-21
Mobile Phone/Display Mode	716	F1h CCh	Disable	6-22
Validate Concatenated Parameter Bar Codes	692	F1h B4h	Disable	6-22
PDF Prioritization	719	F1h CFh	Disable	6-23

Table 6-1 *User Preferences Default Table*

Parameter	Parameter Number	SSI Number	Default	Page Number
PDF Prioritization Timeout	720	F1h D0h	400 ms	6-23
Multicode Mode	677	F1h A5h	Disable	6-24
Multicode Expression	661	F1h 95h	1	6-25
Multicode Mode Concatenation	717	F1h, CDh	Disable	6-33
Multicode Concatenation Symbology	722	F1h, D2h	Concatenate as PDF417	6-34
Miscellaneous Parameters				
Transmit Code ID Character	45	2Dh	None	6-37
SSI Prefix Value	105	69h	<CR>	6-38
SSI Suffix 1 Value	104	68h	<CR>	6-38
SSI Suffix 2 Value	106	6Ah	<CR>	
Non-SSI Prefix Value	99, 105	63h, 69h	<CR><LF>	6-38
Non-SSI Suffix 1 Value	98, 104	62h, 68h	<CR><LF>	6-38
Non-SSI Suffix 2 Value	100, 106	64h, 6Ah	<CR><LF>	
Scan Data Transmission Format	235	EBh	Data as is	6-39
FN1 Substitution Values	103, 109	67h, 6Dh	Set	6-40
Transmit "No Read" Message	94	5Eh	Disable	6-41
Report Version				6-41

User Preferences

Set Default Parameter

You can reset the DS457 to two types of defaults: factory defaults or custom defaults. Scan the appropriate bar code below to reset the imager to its default settings and/or set its current settings as custom defaults.

- **Restore Defaults** - Scan this bar code to reset all default parameters as follows.
 - If you previously set custom defaults by scanning **Write to Custom Defaults**, scan **Restore Defaults** to retrieve and restore the imager's custom default settings.
 - If you did not set custom defaults, scan **Restore Defaults** to restore the factory default values listed in [Table A-1](#).
- **Set Factory Defaults** - Scan this bar code to restore the factory default values listed in [Table A-1](#). This deletes any custom defaults set.
- **Write to Custom Defaults** - Scan this bar code to set the current imager settings as custom defaults. Once set, you can recover custom default settings by scanning **Restore Defaults**.



***Restore Defaults**



Set Factory Defaults



Write to Custom Defaults

Parameter Scanning

Parameter # 236 (SSI # ECh)

To disable the decoding of parameter bar codes, including the **Set Defaults** parameter bar codes, scan the **Disable Parameter Scanning** bar code below. To enable decoding of parameter bar codes, scan **Enable Parameter Scanning**.



***Enable Parameter Scanning
(1)**



**Disable Parameter Scanning
(0)**

User Parameter Pass Through

Parameter # 625 (SSI # F1h 71h)

Enable this to send user-defined parameter bar codes (see [User-Defined Parameter Bar Code Format](#)) as normal decode data in decode data packets for SSI and SNAPI hosts (see [Decode Data Format](#)).

User-Defined Parameter Bar Code Format

Code 128 bar codes with:

<FNC3><L><data>

or

<FNC3><12 bytes of data>

Decode Data Format

<0xf3><L><data>

or

<0xf3><12 bytes of data>

Note that the **B** type only works with 12 bytes of data.

A normal decode beep sounds upon a successful decode of a user-defined parameter bar code.



Enable User Parameter Pass Through
(1)



***Disable User Parameter Pass Through**
(0)

Beep After Good Decode

Parameter # 56 (SSI # 38h)

Scan a bar code below to select whether or not the imager issues a beep signal after a good decode. If selecting **Do Not Beep After Good Decode**, beeper signals still occur during parameter menu scanning and to indicate error conditions.



***Beep After Good Decode
(Enable)
(1)**

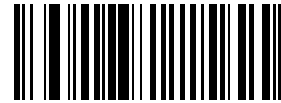

**Do Not Beep After Good Decode
(Disable)
(0)**

Beeper Tone

Parameter # 145 (SSI # 91h)

To select a decode beep frequency (tone), scan the **Low Frequency**, **Medium Frequency**, or **High Frequency** bar code.

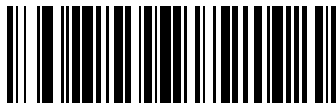

Low Frequency
(2)



***Medium Frequency**
(Optimum Setting)
(1)

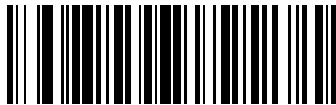

High Frequency
(0)

Beeper Volume

Parameter # 140 (SSI # 8Ch)

To select a beeper volume, scan the **Low Volume**, **Medium Volume**, or **High Volume** bar code.



Low Volume
(2)



Medium Volume
(1)



***High Volume**
(0)

Suppress Power-up Beeps

Parameter # 721 (SSI # F1h D1h)

Select whether or not to suppress the imager's power-up beeps.



*** Do Not Suppress Power-up Beeps**
(0)

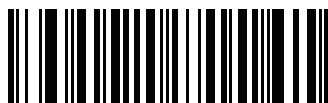

Suppress Power-up Beeps
(1)

Trigger Mode

Parameter # 138 (SSI # 8Ah)

- **Level** - A trigger event activates decode processing, which continues until the trigger event ends, a valid decode, or the decode session time-out occurs.
- **Presentation Mode** - When the DS457 detects an object in its field of view, it triggers and attempts to decode. The range of object detection does not vary under normal lighting conditions. This applies to decode mode only. In this mode the unit does not enter Low Power mode.
- **Host** - A host command issues the triggering signal. The DS457 interprets a trigger pull as a level triggering option.
- **Software Trigger Only Mode** - This option disables the hardware trigger so that only a host command can issue the triggering signal. This is interpreted as a level trigger option.



Level
(0)



*Presentation Mode
(7)



Host
(8)

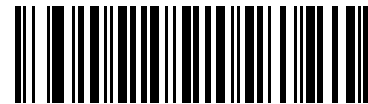

Software Trigger Only Mode
(15)

Presentation Performance Mode

Parameter # 650 (SSI # F1h 8Ah)

Select one of the following Presentation Performance Mode options:

- **Standard Presentation Mode** is optimized for general purpose scanning, i.e., reading bar codes from standard surfaces such as paper labels or hang tags. This mode balances bar code swipe speed (the speed a bar code can pass through the field of view and still be read) and decode range (distance between the imager and the bar code) for optimal performance on standard paper-based bar codes.
- **Enhanced Presentation Mode** is also optimized for general purpose (paper-based) scanning but provides for a faster bar code swipe speed and shorter decode range than **Standard Presentation Mode**. This mode is recommended for applications requiring the highest bar code swipe speed (e.g., automated scanning) or a reduced decode range (e.g., to better match EAS deactivation range or reduce the occurrence of inadvertent reads during hands-free operation).
- **Traditional Presentation Mode** is optimized for applications that require frequent reading of bar codes from mobile phones or PC displays, and improves performance on large 2D symbols. This mode allows more time for the imager to analyze each bar code, improving performance on challenging bar codes such as those on a mobile phone display where the backlight has dimmed. This mode is also recommended for applications that include many truncated or poor quality bar codes. Because swipe speed is reduced, present bar codes to the imager rather than swiping them when using this mode.

✓ **NOTE** To scan bar codes from mobile phones or PC displays, you must enable [Mobile Phone/Display Mode](#) on page 6-22.



*Standard Presentation Mode
(2)



Enhanced Presentation Mode
(0)



Traditional Presentation Mode
(3)

Time Delay to Presentation Idle Mode

Parameter # 663 (SSI # F1h 97h)

In Presentation Mode, this parameter sets the time the imager remains active before entering idle mode with dim illumination. The imager wakes upon presentation of a bar code or a trigger pull.



Disable
(0)

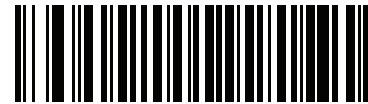

1 Second
(1)



10 Seconds
(10)

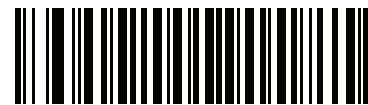

***1 Minute**
(17)



5 Minutes
(21)



15 Minutes
(27)

Time Delay to Presentation Idle Mode (continued)

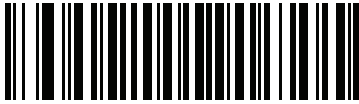

**30 Minutes
(29)**



**45 Minutes
(30)**

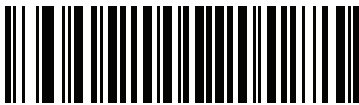

**1 Hour
(33)**

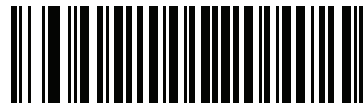

**3 Hours
(35)**

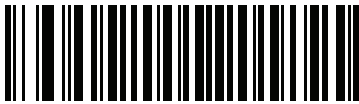

**6 Hours
(38)**

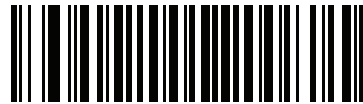

**9 Hours
(41)**

Time Delay to Presentation Sleep Mode

Parameter # 662 (SSI # F1h 96h)

In Presentation Mode, this parameter sets the time the imager remains active before entering sleep mode with no illumination. The imager wakes when it senses motion, upon presentation of a bar code, or a trigger pull.

✓ **NOTE** Imager performance is not guaranteed in dim conditions.

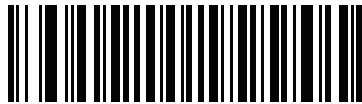

Disable
(0)



1 Second
(1)



10 Seconds
(10)



***1 Minute**
(17)



5 Minutes
(21)

Time Delay to Presentation Sleep Mode (continued)



**15 Minutes
(27)**



**30 Minutes
(29)**



**45 Minutes
(30)**



**1 Hour
(33)**



**3 Hours
(35)**



**6 Hours
(38)**

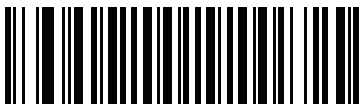

**9 Hours
(41)**

Power Mode (RS-232 Hosts Only)

Parameter # 128 (SSI # 80h)

Select whether or not the imager enters Low Power consumption mode after a decode attempt. In Continuous On mode, the imager does not enter this low power state.



Continuous On
(0)



***Low Power Mode**
(1)

Time Delay to Low Power Mode

Parameter # 146 (SSI # 92h)

This parameter sets the time the imager remains active after decoding. After a scan session, the imager waits this amount of time before entering Low Power mode.



NOTE This parameter only applies when *Power Mode* is set to **Low Power**.
To program a different value for this parameter than those provided here, see [Using Time Delay to Low Power Mode with SSI on page 8-7](#).



***1 Second**
(17)



5 Seconds
(21)

Time Delay to Low Power Mode (continued)



1 Minute
(33)



5 Minutes
(37)



15 Minutes
(43)



1 Hour
(49)

Picklist Mode

Parameter # 402 (SSI # F0h 92h)

Picklist mode enables the imager to decode only bar codes aligned under the center of the laser aiming pattern. Select one of the following picklist modes:

- **Disabled Always** - Picklist mode is always disabled.
- **Enabled Always** - Picklist mode is always enabled.

✓ **NOTE** With Picklist Mode enabled, the decode aiming pattern turns on even when the [Decode Aiming Pattern on page 7-6](#) is disabled.

Picklist mode does not apply to OCR reading.



***Disabled Always**
(0)



Enabled Always
(2)

Decode Session Timeout

Parameter # 136 (SSI # 88h)

This parameter sets the maximum time decode processing continues during a scan attempt. It is programmable in 0.1 second increments from 0.5 to 9.9 seconds. The default timeout is 9.9 seconds.

To set a Decode Session Timeout, scan the bar code below. Next, scan two numeric bar codes from [Appendix D, Numeric Bar Codes](#) that correspond to the desired on time. Provide a leading zero for single digit numbers. For example, to set a Decode Session Timeout of 0.5 seconds, scan the bar code below, then scan the **0** and **5** bar codes. To correct an error or change the selection, scan [Cancel on page D-3](#).



Decode Session Timeout

Timeout Between Decodes, Same Symbol

Parameter # 137 (SSI # 89h)

Use this option in presentation mode to prevent multiple reads of a symbol left in the DS457's field of view. The timeout begins when you remove the symbol from the field of view.

To select the timeout between decodes for the same symbol, available in 0.1 second increments from 0.0 to 9.9 seconds, scan the bar code below, then scan two numeric bar codes from [Appendix D, Numeric Bar Codes](#) that correspond to the desired interval. The default interval is 0.6 seconds.



Timeout Between Decodes, Same Symbol

Continuous Bar Code Read

Parameter # 649 (SSI # F1h 89h)

Select **Enable** to allow decode processing to continue until the trigger event ends or the decode session time-out occurs. User indications occur upon decoding each bar code. Select **Disable** to end decode processing upon a valid decode as well. This mode does not apply to presentation mode.

- ✓ **NOTE** Zebra strongly recommends enabling [Picklist Mode on page 6-19](#) with this feature. Disabling Picklist Mode can cause accidental decodes when more than one bar code is in the imaging engine's field of view.



*Disable Continuous Bar Code Read
(0)

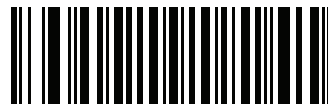

Enable Continuous Bar Code Read
(1)

Unique Bar Code Reporting

Parameter # 723 (SSI # F1h D3h)

Enable this to report only unique bar codes while the trigger is pressed. This option only applies when *Continuous Bar Code Read* is enabled.



Disable Unique Bar Code Reporting
(0)



*Enable Unique Bar Code Reporting
(1)

Mirrored Image

Parameter # 624 (SSI # F1h 70h)

Enable this to scan images in reverse, or mirrored, as if seen through a mirror. This mode is useful in applications requiring scanning through a mirror and using symbologies that do not decode in reverse.

Enabling this mode when using snapshot, video, or video viewfinder modes transmits images as mirrored images.



*Disable Mirrored Image
(0)



Enable Mirrored Image
(1)

Mobile Phone/Display Mode

Parameter # 716 (SSI # F1h CCh)

This mode improves bar code reading performance with target bar codes displayed on mobile phones and electronic displays.

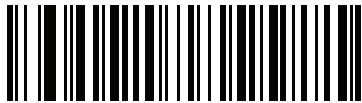

***Disable Mobile Phone/Display Mode
(0)**

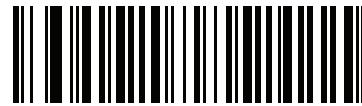

**Enable Mobile Phone/Display Mode
(3)**

Validate Concatenated Parameter Bar Codes

Parameter # 692 (SSI # F1h B4h)

The imager can encounter invalid parameters when using concatenated parameter bar codes intended for different imager models or different versions of an imager. This parameter determines how to process concatenated parameter bar codes when the imager encounters an invalid parameter setting in the bar code.

Disable this to ignore invalid parameters and configure valid parameters. Enable this to ignore all parameters if one or more are invalid.



***Disable Validate Concatenated Parameter Bar Codes
(0)**



**Enable Validate Concatenated Parameter Bar Codes
(1)**

PDF Prioritization

Parameter # 719 (SSI # F1h CFh)

Enable this feature to delay decoding a 1D bar code (Code 128 of 8 to 25 characters length) by the value specified in [PDF Prioritization Timeout](#). During that time the imager attempts to decode a PDF417 symbol (e.g., on a US driver's license), and if successful reports this only. If it does not decode (can not find) a PDF417 symbol, it reports the 1D symbol after the timeout. The 1D symbol must be in the device's field of view for the imager to report it. This parameter does not affect decoding other symbologies.



*Disable PDF Prioritization
(0)



Enable PDF Prioritization
(1)

PDF Prioritization Timeout

Parameter # 720 (SSI # F1h D0h)

When [PDF Prioritization](#) is enabled, this timeout specifies how long the imager attempts to decode a PDF417 symbol before reporting the 1D bar code in the field of view.

Scan the following bar code, then scan four digits from [Appendix D, Numeric Bar Codes](#) that specify the timeout in milliseconds. For example, to enter 200 ms, scan the following bar code, then scan 0200. The range is 0 to 5000 ms, and the default is 400 ms.



PDF Prioritization Timeout



NOTE PDF Prioritization Timeout must be at least one second lower than the Decode Session Timeout.

Multicode Mode

Parameter # 677 (SSI # F1h, A5h)

Enable this parameter to allow multiple bar codes to decode upon one trigger event based on the programmed multicode expression. The imager reports a successful decode and provides user indication only if it decodes all bar codes indicated by the multicode expression, otherwise the decode fails. Bar codes are transmitted in the order defined in the multicode expression. Disable this to operate in normal decode mode.

✓ **NOTE** DS457-DP does not support Multicode Mode.

This mode operates in Level trigger mode only. Also disable *Continuous Bar Code Read*. If you enable this mode, always orient the imager at the same distance and angle (perpendicular).



*Disable Multicode Mode
(0)



Enable Multicode Mode
(1)

Multicode Expression

Parameter # 661 (SSI # F1h, 95h)

Use this feature to program a multicode expression for *Multicode Mode* (grid method). The default is 1, which indicates any bar code.

✓ **NOTE** DS457-DP does not support this parameter.

To set the multicode expression:

1. Scan the bar code below.
2. Scan bar codes from the Alphanumeric Keyboard in the *Advanced Data Formatting Programmer Guide*.
3. Scan End of Message in the *Advanced Data Formatting Programmer Guide*.



Multicode Expression

Multicode Expression Syntax: [n] [Element 1]; [Element 2]; ... [Element n];

Where n is the number of elements in the overall expression.

The multicode expression describes the bar code(s) that the imager can expect to find in an image. Each element represents one bar code in the DS457's field of view. The order of elements in the expression is the order in which bar code data from each element transmits to the host. Elements are defined using one or more of the following methods:

By Region. This type of element limits decoding to a specific area within the DS457's field of view. Region coordinates are defined as the top left and bottom right corners of the region, expressed in percentages of the field of view. These can range from 0% to 100%, or 0x00 to 0x64 in hex, for both horizontal and vertical axes. A region element is constructed as:

[R] [4] [Top, Left] [Bottom, Right]

Where:

- [R] is the character R
- [4] is 0x04, indicating there are four bytes thereafter to describe the region
- [Top, Left] are two values representing the top left corner of the region
- [Bottom, Right] are two values representing the bottom right corner of the region

Note that the top of the field of view used for multicode expressions is the topmost part of the field of view when the DS457's chassis rests on a horizontal surface.

By Code Type. An element can specify a specific bar code symbology to find and decode somewhere in the field of view. A code type element is constructed as:

[C] [2] [Code Type]

Where:

- [C] is the character C
- [2] is 0x02, indicating there are two bytes thereafter to describe the code type
- [Code Type] is the desired symbology's parameter number (see [Chapter 12, Symbologies](#)). For single-byte parameter numbers, extend the value to two bytes by adding 00 before the parameter number.

Notes

When defining multicode expressions consider the following:

- Use the Code Type specifier if there are bar codes of more than one code type in view.
- Always use the Region specifier when there are multiple bar codes of the same code type.
- When transmission order is important (the first element in the expression transmits first), use either type to define the order.
- When there are unwanted bar codes in view, filter them out in one of two ways:
 - Use Code Type to specify only the target bar codes.
 - Use Region to identify only the target bar codes.
- If the expression does not contain a Region specifier, scanning angle and distance do not matter. If you specify a region you must scan in a fixed orientation and at a fixed distance. Because of this, it is preferable to use the Code Type specifier rather than the Region specifier.
- When defining regions:
 - Defining a region much larger than the bar code improves tolerance to scan distance and angle, but can cause a decode of a nearby bar code instead of the target bar code. Therefore, for best performance define larger regions when only a few bar codes are in view and those in view are widely separated.
 - Defining a region close to (or smaller than) the target bar code improves the probability of decoding this bar code rather than one nearby, but scan distance and angle must be more accurate. Therefore, for best performance define small regions when many bar codes are in view or those in view are close together.
- Use Region elements to improve decode speeds by reducing the image area to search for the target bar code.
- Specifying Code Type may also improve decode speeds for some code types.
- Although you can scan parameter bar codes when multicode mode is enabled, be aware of the following: If the multicode expression defined a region(s), to scan a parameter bar code you must position the bar code within the first region defined in the expression. In some cases, this first region is not the center of the image and aiming at the parameter bar code does not result in a successful decode.

The following examples show the multicode expressions in both hex and decimal formats, however in the sample figures the values are decimal. Be sure to use the correct base numbering system when creating an expression. A region specified as 0x00 0x00 0x64 0x32 represents a region with coordinates of Top-Left (0,0) and Bottom Right (100,50).

Example 1

To decode one Code 128 bar code anywhere in the image (even when bar codes of other types are in view), as in [Figure 6-1](#), program the expression as follows:

The expression in decimal is (formatted for readability):

```
1 C 2 0 8 ;
```

To program the expression via scanning parameters the sequence is (spaces are for readability):

```
[MultiCode-Expression] 01 C 02 00 08 ; [End Of Message]
```

To program the expression via host command (SSI/SNAPI) the sequence is:

```
0x01 0x43 0x02 0x00 0x08 0x3b
```

For more information on this method, see [Programming a Multicode Expression via SSI Command on page 6-31](#).

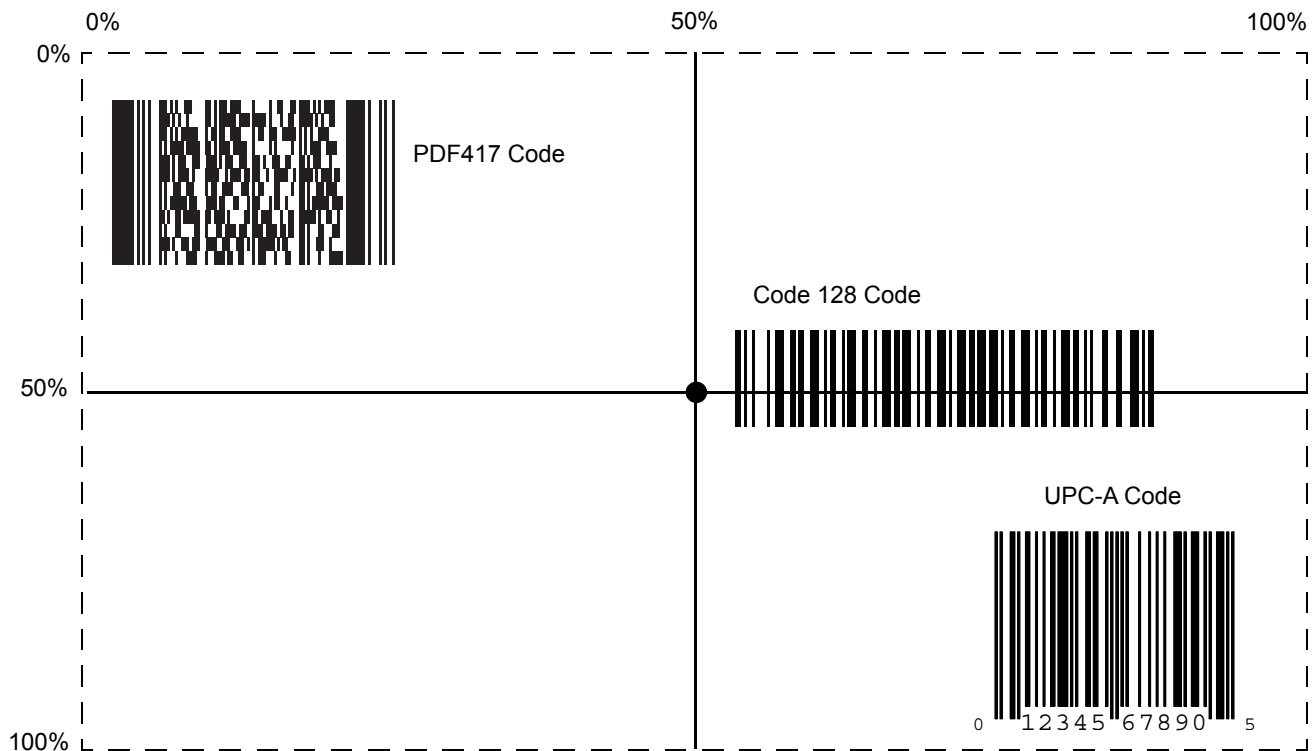

Figure 6-1 Multicode Expression Example 1

Example 2a

To decode a Code128 (Code Type=8) on the top half of the image and a PDF417 (Code Type=15) on the bottom half of the image, as in [Figure 6-2](#), program the expression as follows:

The expression in decimal is (formatted for readability):

```
2 C 2 0 8 R 4 0 0 100 50 ; C 2 0 15 R 4 0 50 100 100 ;
```

To program the expression via scanning parameters the sequence is:

```
[MultiCode-Expression] 02 C 02 00 08 R 04 00 00 64 32 ; C 02 00 0F R 04 00 32 64 64 ; [End Of Message]
```

To program the expression via host command (SSI/SNAPI) the sequence is:

```
0x02 0x43 0x02 0x00 0x08 0x52 0x04 0x00 0x00 0x64 0x32 0x3B 0x43 0x02 0x00 0x0F 0x52 0x04 0x00  
0x32 0x64 0x64 0x3B
```

For more information on this method, see [Programming a Multicode Expression via SSI Command on page 6-31](#).

Example 2b

In [Figure 6-2](#), if the bottom PDF417 bar code must transmit first, reverse the sequence of the two bar codes:

The expression in decimal is (formatted for readability):

2 C 2 0 15 R 4 0 50 100 100 ; C 2 0 8 R 4 0 0 100 50 ;

To program the expression via scanning parameters the sequence is:

[MultiCode-Expression] 02 C 02 00 0F R 04 00 32 64 64 ; C 02 00 08 R 04 00 00 64 32 ; [End Of Message]

To program the expression via host command (SSI/SNAPI) the sequence is:

0x02 0x43 0x02 0x00 0x0F 0x52 0x04 0x00 0x32 0x64 0x64 0x3B 0x43 0x02 0x00 0x08 0x52 0x04 0x00
0x00 0x64 0x32 0x3B

For more information on this method, see [Programming a Multicode Expression via SSI Command on page 6-31](#).



Figure 6-2 Multicode Expression Example 2

Example 3

To decode the set of three bar codes while excluding the center Code 128 bar code, as in [Figure 6-3](#), the expression is:

The expression in decimal is (formatted for readability):

```
3 C 2 0 15 R 4 0 0 50 50 ; C 2 [F0 24] R 4 70 0 100 40 ; C 2 0 8 R 4 65 60 100 100 ;
```

To program the expression via scanning parameters the sequence is:

```
[MultiCode-Expression] 03 C 02 00 0F R 04 00 00 32 32 ; C 02 F0 24 R 04 46 00 64 28 ;  
C 02 00 08 R 04 41 3C 64 64 ; [End Of Message]
```

To program the expression via host command (SSI/SNAPI) the sequence is:

```
0x03 0x43 0x02 0x00 0x0F 0x52 0x04 0x00 0x00 0x32 0x32 0x3B 0x43 0x02 0xF0 0x24 0x52 0x04 0x46  
0x00 0x64 0x28 0x3B 0x43 0x02 0x00 0x08 0x52 0x04 0x41 0x3C 0x64 0x64 0x3B
```

For more information on this method, see [Programming a Multicode Expression via SSI Command on page 6-31](#).

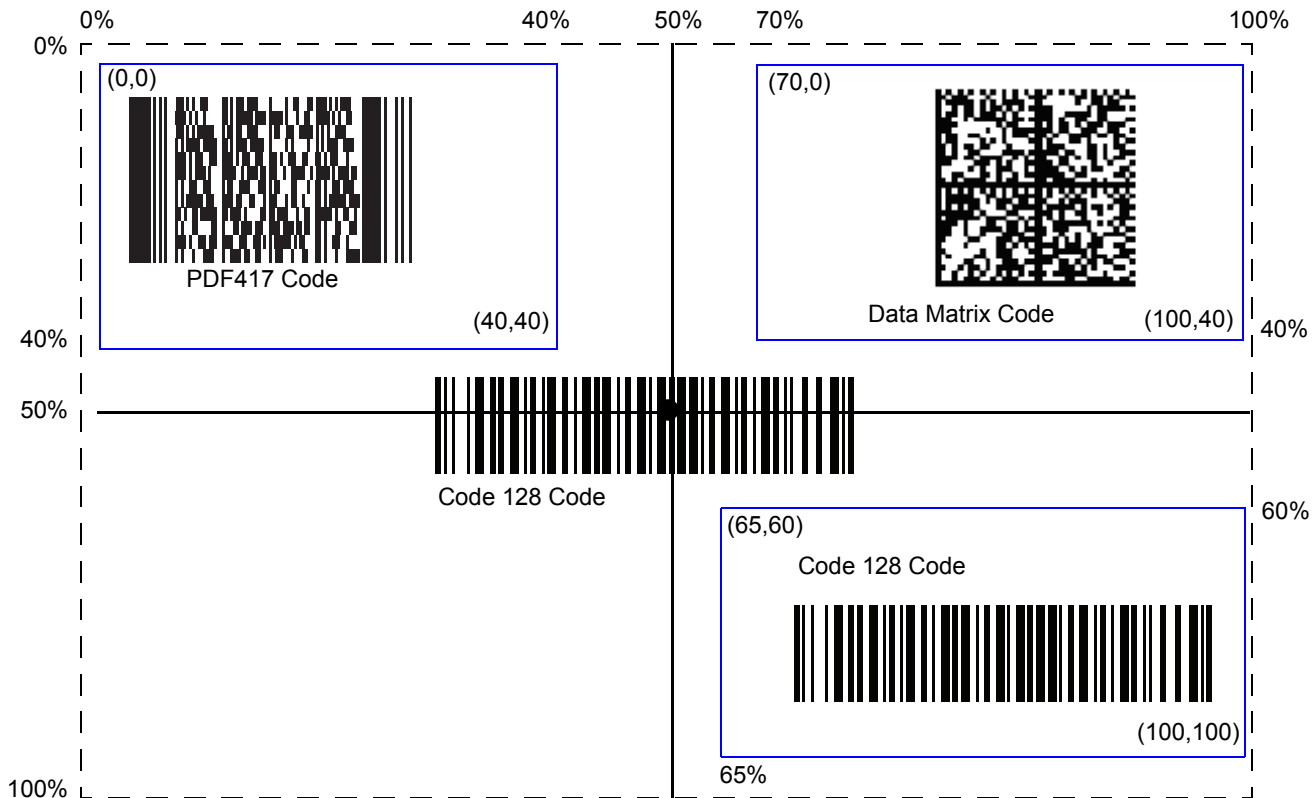

Figure 6-3 Multicode Expression Example 3

Programming a Multicode Expression via SSI Command

The following example describes how to program a Multicode expression via SSI within a Remote Scanner Management (RSM) command.

SSI Transaction Sequences

Before sending the Multicode expression transaction (a command/response pair), perform the following initialization transaction (command and response). This initialization transaction is required only once upon each imager power up:

```
Command (to imager):    0A 80 04 00 00 06 20 00 00 FF FE 4D
Response (from imager): 0C 80 00 00 00 08 20 00 00 F0 00 F0 FD 6C
```

Next, program the Multicode Expression using the following basic transaction format.

```
Command (to imager):    17 80 04 00 00 13 06 00 02 95 41 00 42 00 06 00 [Multicode Expression in Hex] FD A3
Response (from imager): 08 80 00 00 00 04 06 00 FF 6E
```

For full details on structuring Multicode expression commands, see [Figure 6-4](#).

Legend for Figure 6-4

- All values in the table are hex, unless followed by a **d** which indicates decimal.
- Shaded fields represent values that change for different Multicode expressions. Unshaded fields are fixed and are constant for all expressions.
- **N**: The length of the Multicode expression in bytes. Using **Example 1**, **N** = 6 decimal, 0x06 hex.
- **Len1**: N+17. Using **Example 1**, **Len1** = 23 decimal, 0x17 hex.
- **Len2**: N+13. Using **Example 1**, **Len2** = 19 decimal, 0x13 hex.
- **Op**: Command persistence.
 - 0x06 stores the Multicode expression in non-volatile memory. The command persists through power cycling.
 - or
 - 0x05 stores the Multicode expression in RAM. The command is lost when power is removed from the imager.
- **Len4**: Same value as **N**. Using **Example 1**, **Len4** = 6 decimal, 0x06 hex.
- **Checksum**: 2's compliment checksum of bytes in the SSI Header and SSI Data. Sum all bytes, truncate to a 2 byte value, subtract this value from 0x10000; the resulting number is the 2 byte checksum. Using **Example 1** the checksum is **FDA3**.

	SSI Header		SSI Data = RSM Command							Checksum	
	Len1	Fixed	Fixed	Len2	Op	Fixed	Len3	Fixed	Multicode Expression	MSB	LSB
Example 1	17 (23d)	80 04 00	00	13 (19d)	06	00 02 95 41 00 42 00	06 (06d)	00 00	01 43 02 00 08 3B (N=6d)	FD	A3

Figure 6-4 SSI Formatting of a Multicode Expression

Multicode Mode Concatenation

Parameter # 717 (SSI # F1h, CDh)

Enable this parameter to transmit multiple decoded bar codes, as specified by the *Multicode Expression*, as one bar code. Use the *Multicode Concatenation Symbology* parameter to specify how the concatenated bar codes transmit.

Disable this to transmit decoded bar codes separately.

✓ **NOTE** When using Multicode Mode Concatenation, disable *Transmit Code ID Character on page 6-37* and check digits.

DS457-DP does not support this parameter.



Enable Multicode Mode Concatenation
(1)



*Disable Multicode Mode Concatenation
(0)

Multicode Concatenation Symbology

Parameter # 722 (SSI # F1h, D2h)

Use this parameter to specify how to transmit the concatenated bar codes decoded as specified by the *Multicode Expression*. *Multicode Mode Concatenation* must be enabled to use this option.

✓ **NOTE** DS457-DP does not support this parameter.



Concatenation as Code 128
(1)

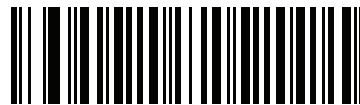

*Concatenation as PDF417
(2)



Concatenation as Data Matrix
(3)



Concatenation as Maxicode
(4)

Multicode Troubleshooting

Troubleshooting Multicode Expression Programming

Use the following suggestions if encountering problems programming a multicode expression:

- Ensure the expression is valid. Invalid expressions are rejected during programming. When an expression is rejected the previous expression remains intact. If after programming the expression the imager can still decode any bar code, the expression was possibly rejected.
- When programming the multicode expression via parameter bar code, the DS457 generates beeps. If any of the following beeps do not sound during programming, an error occurred (see [Table 3-1 on page 3-4](#) for error indicators):
 - Scanning the **Multicode Expression** bar code produces a two-tone (same pitch) beep.
 - Scanning each value of the expression produces a two-tone (same pitch) beep.
 - Scanning the **End Of Message** bar code produces a four-tone (high-low-high-low) beep.
- Check the expression for syntax errors.
- Try programming a simple expression to ensure the syntax is correct. See [Examples of Simple Multicode Expressions](#).
- Review [Notes on page 6-26](#) for additional hints.

Troubleshooting Multicode Mode Scanning and Decoding

Use the following suggestions if encountering problems using multicode mode:

- If the DS457 appears to decode any single bar code instead of the intended multiple bar codes, ensure you enabled [Multicode Mode on page 6-24](#). Programming the multicode expression does not enable multicode mode.
- When specifying **Region**, ensure:
 - Coordinates are within range the 0-100 decimal (or 0x00 - 0x64 hexadecimal).
 - Top, Left is above Bottom, Right. Top, Left is 0,0 (0x00, 0x00 hexadecimal), and Bottom, Right is 100,100 (0x64, 0x64 hexadecimal).
 - Regions for two or more bar codes do not overlap.
- When specifying **Code Type** ensure the DS457 supports the code type. Try decoding a single bar code without using multicode. If it does not decode try enabling the bar code type. See [Chapter 12, Symbolologies](#).
- Experiment with simpler expressions, then add to it until you discover the source of the error. For example try the simplest expression (see [Examples of Simple Multicode Expressions](#)) and make sure you can scan a single bar code. If so, extend the expression by adding a second bar code, specifying a region, or specifying the code type. Verify that the DS457 can decode this new expression. Continue adding to the expression until it fails to decode as expected, indicating the source of the error.
- Review [Notes on page 6-26](#) for additional hints.

Examples of Simple Multicode Expressions

The simplest multicode expression is:

- One bar code of any type, anywhere in the image.
- To program this use: **[MultiCode-Expression] 01 ; [End Of Message]**

Another simple multicode expression is:

- One Code 128 bar code, anywhere in the image.
- To program this use: **[MultiCode-Expression] 01 C 02 00 08 ; [End Of Message]**

Miscellaneous Parameters

Transmit Code ID Character

Parameter # 45 (SSI # 2Dh)

A Code ID character identifies the code type of a scanned bar code. This is useful when the imager is decoding more than one code type. In addition to any single character prefix already selected, the Code ID character is inserted between the prefix and the decoded symbol.

Select no Code ID character, a Symbol Code ID character, or an AIM Code ID character. For Code ID Characters, see [Code Identifiers on page B-1](#).

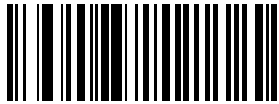

Symbol Code ID Character
(2)



AIM Code ID Character
(1)

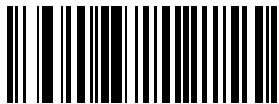

*None
(0)

Prefix/Suffix Values

Parameter # Prefix = 105, Suffix1 = 104, Suffix2 = 106

Key Category Parameter # Prefix = 63h, Suffix1 = 62h, Suffix2 = 64h

Decimal Value Parameter # Prefix = 69h, Suffix1 = 68h, Suffix2 = 6Ah

A prefix and/or one or two suffixes can be appended to scan data for use in data editing. To set a value for a prefix or suffix, scan the prefix or suffix bar code below, then scan a four-digit number (i.e., four bar codes from [Appendix D, Numeric Bar Codes](#)) that corresponds to that value. The first digit defines the key category (type of character to send) and is stored in the key category parameter. The remaining three digits define the value of the character and are stored in the decimal value parameter. Be sure to use both key category and decimal value parameters to define the prefix/suffix value.

See [Table E-1 on page E-1](#) for the four-digit code values. To correct an error or change a selection, scan [Cancel on page D-3](#).



NOTE When using the imager with an SSI or SNAPI host, only a key category value of 1 is valid. All other values are ignored.

To send a Prefix or Suffix with bar code data, first enable the format in which they are sent by setting the [Scan Data Transmission Format on page 6-39](#).

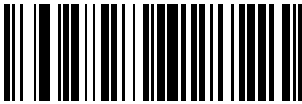

**Scan Prefix
(7)**

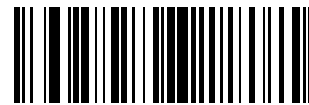

**Scan Suffix 1
(6)**



**Scan Suffix 2
(8)**

Scan Data Transmission Format

Parameter # 235 (SSI # EBh)

To change the scan data format, scan one of the following eight bar codes corresponding to the desired format.

✓ **NOTE** If using this parameter do not use ADF rules to set the prefix/suffix.

To set values for the prefix and/or suffix, see [Prefix/Suffix Values on page 6-38](#).



***Data As Is**
(0)



<DATA> <SUFFIX 1>
(1)



<DATA> <SUFFIX 2>
(2)



<DATA> <SUFFIX 1> <SUFFIX 2>
(3)



<PREFIX> <DATA >
(4)

Scan Data Transmission Format (continued)



<PREFIX> <DATA> <SUFFIX 1>
(5)



<PREFIX> <DATA> <SUFFIX 2>
(6)



<PREFIX> <DATA> <SUFFIX 1> <SUFFIX 2>
(7)

FN1 Substitution Values

Key Category Parameter # 103 (SSI # 67h)

Decimal Value Parameter # 109 (SSI # 6Dh)

The Wedge and USB HID Keyboard hosts support a FN1 Substitution feature. When enabled any FN1 character (0x1b) in an EAN128 bar code is substituted with a value. This value defaults to 7013 (Enter Key).

When using host commands to set the FN1 substitution value, set the key category parameter to 1, then set the 3-digit keystroke value. See the ASCII Character Set table for the currently installed host interface for the desired value.

To select a FN1 substitution value via bar code menus:

1. Scan the bar code below.

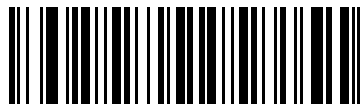

Set FN1 Substitution Value

2. Look up the keystroke desired for FN1 Substitution in the ASCII Character Set table for the currently installed host interface. Enter the 4-digit ASCII Value by scanning each digit in [Appendix D, Numeric Bar Codes](#).

To correct an error or change the selection, scan **Cancel**.

To enable FN1 substitution for USB HID keyboard, scan the **Enable FN1 Substitution** bar code on [page 10-11](#).

Transmit "No Read" Message

Parameter # 94 (SSI # 5Eh)

Scan a bar code below to select whether or not to transmit a No Read message. When enabled, the characters NR are transmitted when a bar code is not decoded. When disabled, if a symbol does not decode, nothing is sent to the host.



**Enable No Read
(1)**



***Disable No Read
(0)**

Report Version

Scan the bar code below to report the version of software currently installed in the imager.



Report Software Version

CHAPTER 7 IMAGER PREFERENCES

Introduction

This chapter describes imager preference features and provides the programming bar codes for selecting these features.

The imager ships with the settings shown in the [Imager Preferences Default Table on page 7-2](#) (also see [Appendix A, Standard Default Parameters](#) for all host and miscellaneous defaults). If the default values suit requirements, programming is not necessary.

There are two ways to change a parameter value:

- Scan the appropriate bar codes in this guide. These new values replace the standard default values in memory.
- For SSI and USB SNAPi hosts, send a “parameter send” command from the host system. Hexadecimal parameter numbers appear in this chapter below the parameter title, and options appear in parenthesis beneath the accompanying bar codes. See the *Simple Serial Interface (SSI) Programmer’s Guide* for detailed instructions for changing parameter values using this method.

✓ **NOTE** Most computer monitors allow scanning the bar codes directly on the screen. When scanning from the screen, be sure to set the document magnification to a level where you can see the bar code clearly, and bars and/or spaces are not merging.

Select a host type (see each host chapter for specific host information) after the power-up beep signal activates. This is only necessary upon the first power-up when connected to a new host.

To return all features to default values, scan the [Set Default Parameter on page 6-5](#). Throughout the programming bar code menus, asterisks (*) indicate default values.

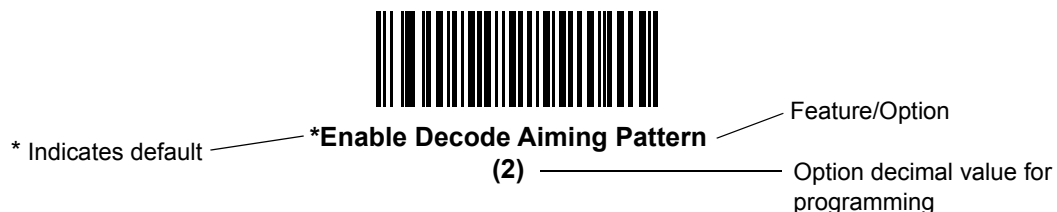

Scanning Sequence Examples

In most cases scanning one bar code sets the parameter value. For example, to disable the decode aiming pattern, scan the **Disable Decode Aiming Pattern** bar code listed under [Decode Aiming Pattern on page 7-6](#). For systems that use a beeper and LED, a fast warble beep sounds and the LED lights, signifying a successful parameter entry.

Other parameters, such as **Crop to Pixel Address**, require scanning several bar codes. See these parameter descriptions for this procedure.

Errors While Scanning

Unless otherwise specified, to correct an error during a scanning sequence, just re-scan the correct parameter.

Imager Preferences Parameter Defaults

[Table 7-1](#) lists defaults for imager preferences parameters. To change any option, scan the appropriate bar code(s) provided in [Imager Preferences on page 7-4](#).

✓ **NOTE** See [Appendix A, Standard Default Parameters](#) for all user preferences, hosts, symbologies, and miscellaneous default parameters

Table 7-1 Imager Preferences Default Table

Parameter	Parameter Number	SSI Number	Default	Page Number
Imaging Options				
Decoding Autoexposure	297	F0h 29h	Enable	7-5
Decoding Illumination	298	F0h 2Ah	Enable	7-6
Decode Aiming Pattern	306	F0h 32h	Enable	7-6
Aim Brightness	668	F1h 9Ch	0	7-7
Illumination Brightness	669	F1h 9Dh	10	7-7
Low Light Enhancement	612	F1h 64h	Disable	7-8
Power Up Light in Presentation Mode	1198	F8h 04h AEh	Disable	7-8
Presentation Mode Field of View	609	F1h 61h	Default (Reduced)	7-9
Frame Rate	674	F1h A2h	Auto	7-10
Image Capture Autoexposure	360	F0h 68h	Enable	7-12
Image Capture Illumination	361	F0h 69h	Enable	7-12
Fixed Gain	568	F1h 38h	50	7-13
Exposure Time	567	F4h F1h 37h	100 (10 ms)	7-13
Snapshot Mode Timeout	323	F0h 43h	0 (30 seconds)	7-14

Table 7-1 *Imager Preferences Default Table (Continued)*

Parameter	Parameter Number	SSI Number	Default	Page Number
Snapshot Aiming Pattern	300	F0h 2Ch	Enable	7-14
Presentation Snapshot by Motion	647	F1h 87h	Disable	7-15
Continuous Snapshot	648	F1h 88h	Disable	7-15
Image Cropping	301	F0h 2Dh	Disable	7-16
Crop to Pixel Addresses	315, 316, 317, 318	F4h F0h 3Bh; F4h F0h 3Ch; F4h F0h 3Dh; F4h F0h 3Eh	0 top, 0 left, 479 bottom, 751 right	7-17
Image Resolution	302	F0h 2Eh	Full	7-18
Image Brightness (Target White)	390	F0h 86h	180	7-19
Image File Format Selection	304	F0h 30h	JPEG	7-20
JPEG Image Options	299	F0h 2Bh	Quality	7-20
JPEG Quality Value	305	F0h 31h	65	7-21
JPEG Size Value	561	F1h 31h	160 (164K)	7-21
Image File Meta Data	693	F1h B5h	Disable	7-22
Image Enhancement	564	F1h 34h	Off	7-23
Image Edge Sharpening	664	F1h 98h	Low	7-24
Image Contrast Enhancement	666	F1h 9Ah	Off	7-25
Image Rotation	665	F1h 99h	0	7-26
Bits per Pixel (BPP)	303	F0h 2Fh	8 BPP	7-27
Signature Capture	93	5Dh	Disable	7-28
Signature Capture Image File Format Selection	313	F0h 39h	JPEG	7-29
Signature Capture Bits per Pixel (BPP)	314	F0h 3Ah	8 BPP	7-30
Signature Capture Width	366	F4h F0h 6Eh	400	7-30
Signature Capture Height	367	F4h F0h 6Fh	100	7-31
Signature Capture JPEG Quality	421	F0h A5h	65	7-31
Video Mode Format Selector	916	F2h 94h	JPEG	7-32
Video View Finder	324	F0h 44h	Disable	7-32
Target Video Frame Size	328	F0h 48h	2200 bytes	7-33
Video View Finder Image Size	329	F0h 49h	1700 bytes	7-33
Video Resolution	667	F1h 9Bh	1/4 resolution	7-34

Imager Preferences

The parameters in this chapter control image capture characteristics. Image capture occurs in all modes of operation, including decode, video, and snapshot.

Operational Modes

The imager has three modes of operation:

- Decode Mode
- Snapshot Mode
 - Snapshot with Viewfinder Mode
- Video Mode.

Decode Mode

By default, upon a trigger event, the imager attempts to locate and decode bar codes within its field of view. The imager remains in this mode as long as the trigger is active, until it decodes a bar code, or it reaches the [Decode Session Timeout on page 6-19](#).

Snapshot Mode

Use Snapshot Mode to capture a high-quality image and transmit it to the host. To temporarily enter this mode scan the **Snapshot Mode** bar code. While in this mode the imager blinks the green LED at 1-second intervals to indicate it is not in standard operating (decode) mode.

In Snapshot Mode, the DS457 laser aiming pattern highlights the area to capture in the image. The next trigger event instructs the imager to capture a high quality image and transmit it to the host. A short time may pass (less than 2 seconds) between trigger activation and image capture as the imager adjusts to the lighting conditions. Hold the imager steady until image capture, denoted by a single beep.

If a trigger event does not occur within the Snapshot Mode Timeout period, the imager returns to Decode Mode. Use [Snapshot Mode Timeout on page 7-14](#) to adjust this timeout period. The default timeout period is 30 seconds.

To disable the laser aiming pattern during Snapshot Mode, see [Snapshot Aiming Pattern on page 7-14](#).

Use [Video View Finder on page 7-32](#) to enable **Snapshot with Viewfinder Mode**. In this mode the imager behaves as a video camera until the trigger activates, at which time a Snapshot occurs as described above.

Video Mode

In this mode the imager behaves as a video camera as long as the trigger is active. Upon trigger release, the imager returns to Decode Mode. Scan the **Video Mode** bar code to temporarily enter Video Capture Mode.

- ✓ **NOTE** The DS457 does not support **Video Mode** when *Trigger Mode on page 6-11* is set to **Presentation Mode** (the default).

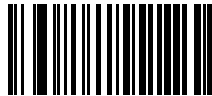

Snapshot Mode

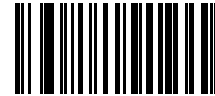

Video Mode

Decoding Autoexposure

Parameter # 297 (SSI # F0h 29h)

Select **Enable Decoding Autoexposure** to allow the imager to control gain settings and exposure (integration) time to best capture an image for decode mode.

Select **Disable Decoding Autoexposure** to manually adjust the gain and exposure time (see *Fixed Gain* and *Exposure Time*). Zebra recommends this option only for advanced users with difficult decoding situations.

- ✓ **NOTE** Decoding Autoexposure does not apply in Presentation Mode.



***Enable Decoding Autoexposure**
(1)



Disable Decoding Autoexposure
(0)

Decoding Illumination

Parameter # 298 (SSI # F0h 2Ah)

Selecting **Enable Decoding Illumination** causes the imager to turn on illumination every image capture to aid decoding. Select **Disable Decoding Illumination** to prevent the imager from using decoding illumination.

Enabling illumination usually results in superior images. The effectiveness of illumination decreases as the distance to the target increases.

✓ **NOTE** Changing this parameter while using Presentation Mode, with or without Motion Enhancement, is not recommended.



*Enable Decoding Illumination
(1)



Disable Decoding Illumination
(0)

Decode Aiming Pattern

Parameter # 306 (SSI # F0h 32h)

This parameter only applies in Decode Mode. Select **Enable Decode Aiming Pattern** to project the aiming pattern during bar code capture, or **Disable Decode Aiming Pattern** to turn the aiming pattern off.

✓ **NOTE** If [Picklist Mode on page 6-19](#) is enabled, the decode aiming pattern turns on even when disabled.



*Enable Decode Aiming Pattern
(2)



Disable Decode Aiming Pattern
(0)

Aim Brightness

Parameter # 668 (SSI # F1h 9Ch)

This feature sets the brightness of the aim pattern. The default is 0, which indicates that the aim pattern is always on in between camera exposures. For values above 0, each increment of the brightness value increments the aim duration 0.5 ms.

To program Aim Brightness, scan this bar code followed by three numeric bar codes in [Appendix D, Numeric Bar Codes](#) that correspond to the value representing brightness. Settings range from 0 to 255. The maximum aim duration is limited by the frame time, so the recommended range is 0 to 30 when the frame rate is set to 60 fps.



Aim Brightness

Illumination Brightness

Parameter # 669 (SSI # F1h 9Dh)

This feature sets the brightness of the illumination by altering LED power. The default is 10, which is maximum LED brightness. For values from 1 to 10, LED brightness varies from lowest to highest level of brightness.

To program Illumination Brightness, scan this bar code followed by two numeric bar codes in [Appendix D, Numeric Bar Codes](#) that correspond to the value of desired illumination brightness. For example, to set Illumination Brightness to 6, scan the bar code below followed by the 0 and 6 bar codes.



Illumination Brightness

Low Light Enhancement

Parameter # 612 (SSI # F1h 64h)

In Presentation Mode, selecting **Enable Low Light Enhancement** causes illumination to remain on at low power in low lighting conditions. When the imager detects an object in its field of view, it turns on illumination full power. Select **Disable Low Light Enhancement** to prevent illumination from remaining on under low lighting conditions



Enable Low Light Enhancement
(1)

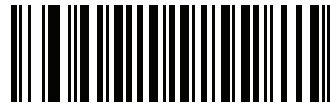

*Disable Low Light Enhancement
(0)

Power Up Light in Presentation Mode

Parameter # 1198 (SSI # F8h 04h AEh)

Enable this option to turn on full illumination upon power-up when in presentation mode or transitioning to presentation mode. If *Low Light Enhancement* is also enabled, illumination turns on at low power in presentation mode. If both are disabled, illumination remains off until motion is detected.



Enable Power Up Light in Presentation Mode
(1)



*Disable Power Up Light in Presentation Mode
(0)

Presentation Mode Field of View

Parameter # 609 (SSI # F1h 61h)

In Presentation Mode, by default the imager searches for a bar code in a smaller region around the aiming pattern's center cross to speed search time.

To use a full field of view, scan **Presentation Mode Full Field of View**. This allows the imager to search the larger area of the aiming pattern.

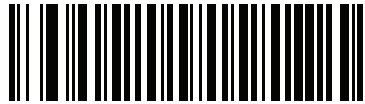

***Presentation Mode Default Field of View
(1)**



**Presentation Mode Full Field of View
(2)**

Frame Rate

Parameter # 674 (SSI # F1h A2h)

Select an option to control the rate at which frames are captured and transmitted. When capturing images, using lower frame rates can improve image brightness.

✓ **NOTE** The aiming pattern appears to blink when the frame rate is 30 frames per second (fps) or lower.

Settings for frame rate are:

- Auto - The imager controls the frame rate and changes dynamically based on the mode of operation to provide optimal performance.
- 60 fps - The frame rate is fixed at 60 frames per second
- 55 fps - The frame rate is fixed at 55 frames per second
- 50 fps - The frame rate is fixed at 50 frames per second
- 45 fps - The frame rate is fixed at 45 frames per second
- 40 fps - The frame rate is fixed at 40 frames per second
- 30 fps - The frame rate is fixed at 30 frames per second
- 20 fps - The frame rate is fixed at 20 frames per second
- 15 fps - The frame rate is fixed at 15 frames per second
- 10 fps - The frame rate is fixed at 10 frames per second



***Auto**
(0)



60 fps
(1)



55 fps
(5)



50 fps
(6)

Frame Rate (continued)



45 fps
(7)

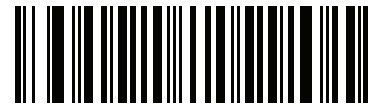

40 fps
(8)



30 fps
(2)



20 fps
(9)

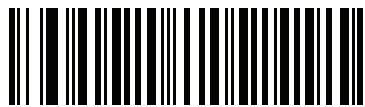

15 fps
(3)



10 fps
(4)

Image Capture Autoexposure

Parameter # 360 (SSI # F0h 68h)

Select **Enable Image Capture Autoexposure** to allow the imager to control gain settings and exposure (integration) time to best capture an image for snapshot mode.

Select **Disable Image Capture Autoexposure** to manually adjust the gain and exposure time (see [Fixed Gain](#) and [Exposure Time](#)). Zebra recommends this option only for advanced users with difficult image capture situations.

✓ **NOTE** Image Capture Autoexposure does not apply in Presentation Mode.

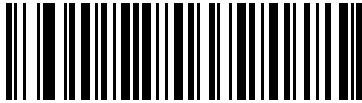

***Enable Image Capture Autoexposure
(1)**

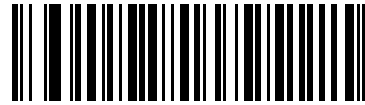

**Disable Image Capture Autoexposure
(0)**

Image Capture Illumination

Parameter # 361 (SSI # F0h 69h)

Selecting **Enable Image Capture Illumination** causes illumination to turn on during every image capture. Disable illumination to prevent the imager from using illumination.

Enabling illumination usually results in superior images. The effectiveness of illumination decreases as the distance to the target increases.



***Enable Image Capture Illumination
(1)**



**Disable Image Capture Illumination
(0)**

Fixed Gain

Parameter # 568 (SSI # F1h 38h)

This parameter only applies when Decoding or Image Capture Autoexposure is disabled. Gain is a means of amplifying the raw image data before it is converted into 8-bit grayscale values. Increasing the fixed gain increases brightness and contrast, but also increases noise (undesired electrical fluctuations in the image) which makes the image less attractive and/or harder to decode.

✓ **NOTE** Fixed Gain does not apply in Presentation Mode.

To set the fixed gain, scan the bar code below followed by 3 bar codes from [Appendix D, Numeric Bar Codes](#), in the range of 1 to 100, representing the value. The default is 50.



Fixed Gain

Exposure Time

Parameter # 567 (SSI # F4h F1h 37h)

This parameter only applies when Decoding or Image Capture Autoexposure is disabled. It configures the exposure for both Decode and Snapshot modes.

✓ **NOTE** Exposure Time does not apply in Presentation Mode.

Each integer value represents 100 μ s worth of exposure. The default value is 100 which results in an exposure setting of 10 ms.

To set the Exposure Time parameter, scan **Fixed Exposure** followed by four numeric bar codes representing the value in the range of 1 - 1000. Insert leading zeros if necessary. For example, to set a Fixed Exposure value of 9.9 ms, scan 0, 0, 9, 9. See [Appendix D, Numeric Bar Codes](#) for numeric bar codes.



Exposure Time
(4 digits)

Snapshot Mode Timeout

Parameter # 323 (SSI # F0h 43h)

This parameter sets the amount of time the imager remains in Snapshot Mode. The imager exits Snapshot Mode upon a trigger event, or when the Snapshot Mode Timeout elapses. To set this timeout value, scan the bar code below followed by a bar code from [Appendix D, Numeric Bar Codes](#). The default value is 0 which represents 30 seconds; values increment by 30. For example, 1 = 60 seconds, 2 = 90 seconds, etc.



Snapshot Mode Timeout

Snapshot Aiming Pattern

Parameter # 300 (SSI # F0h 2Ch)

Select **Enable Snapshot Aiming Pattern** to project the aiming pattern when in Snapshot Mode, or **Disable Snapshot Aiming Pattern** to turn the aiming pattern off.



*Enable Snapshot Aiming Pattern
(1)



Disable Snapshot Aiming Pattern
(0)

Presentation Snapshot by Motion

Parameter # 647 (SSI # F1h 87h)

When the imager detects an object in its field of view, and the object stops moving, it attempts to capture a high quality image and transmit it to the host. This applies to snapshot mode only. Select a bar code below to enable or disable this feature.



***Disable Presentation Snapshot by Motion
(0)**

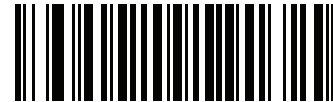

**Enable Presentation Snapshot by Motion
(1)**

Continuous Snapshot

Parameter # 648 (SSI # F1h 88h)

Select **Enable** to stay in Snapshot Mode, and **Disable** to return to normal decode mode after image capture. This only applies in Presentation Snapshot by Motion mode.

If you enable this, you can not scan parameter bar codes to exit this mode. To restore normal decode mode, power cycle the imager, then scan the **Disable Continuous Snapshot** bar code.



***Disable Continuous Snapshot
(0)**



**Enable Continuous Snapshot
(1)**

Image Cropping

Parameter # 301 (SSI # F0h 2Dh)

This parameter crops a captured image. Select **Disable Image Cropping** to present the full 742 x 480 pixels. Select **Enable** to crop the image to the pixel addresses set in [Crop to Pixel Addresses on page 7-17](#).

- ✓ **NOTE** The imager has a cropping resolution of 4 pixels. Setting the cropping area to less than 3 pixels transfers the entire image.



**Enable Image Cropping
(1)**



***Disable Image Cropping
(Use Full 742 x 480 Pixels)
(0)**

Crop to Pixel Addresses

Parameter # 315 (SSI # F4h F0h 3Bh (Top))

Parameter # 316 (SSI # F4h F0h 3Ch (Left))

Parameter # 317 (SSI # F4h F0h 3Dh (Bottom))

Parameter # 318 (SSI # F4h F0h 3Eh (Right))

If Enable Image Cropping is selected, set the pixel addresses from (0,0) to (751,479) to crop to.

Columns are numbered from 0 to 751, rows from 0 to 479. Specify four values for Top, Left, Bottom, and Right, where Top and Bottom correspond to row pixel addresses, and Left and Right correspond to column pixel addresses. For example, for a 4 row x 8 column image in the extreme bottom-right section of the image, set the following values:

Top = 476, Bottom = 479, Left = 744, Right = 751

To set the pixel address to crop to, scan each Pixel Address bar code followed by three bar codes from [Appendix D, Numeric Bar Codes](#) which represent the value. Include leading zeros, so to enter a value of 3, for example, scan **0, 0, 3**.

- ✓ **NOTE** The imager has a minimum cropping resolution of four pixels; increment and decrement cropping addresses in multiples of four. Other values are rounded up. For example, choosing to crop from the top at addresses 0, 1, or 2 (removing 1, 2, or 3 pixels) has the same result as cropping at address 3; this removes four rows from the top.



Top Pixel Address
(0 - 479 Decimal)



Left Pixel Address
(0 - 751 Decimal)



Bottom Pixel Address
(0 - 479 Decimal)



Right Pixel Address
(0 - 751 Decimal)

Image Resolution

Parameter # 302 (SSI # F0h 2Eh)

This option alters image resolution before compression. Rows and columns are removed from the image, resulting in a smaller image containing the original content with reduced resolution.

Select one of the following values:

Resolution Value	Uncropped Image Size
Full	752 x 480
1/2	376 x 240
1/4	188 x 120

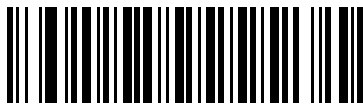

***Full Resolution
(0)**



**1/2 Resolution
(1)**



**1/4 Resolution
(3)**

Image Brightness (Target White)

Parameter # 390 (SSI # F0h 86h)

This parameter sets the Target White value used in Snapshot and Video modes when using autoexposure. White and black are defined as 255 decimal and 0, respectively. Setting the value to the default of 180 results in a white level of ~180 for the image.

To set the Image Brightness parameter, scan **Image Brightness** below followed by three numeric bar codes representing the value. Include leading zeros. For example, to set an Image Brightness value of 99, scan 0, 9, 9. See [Appendix D, Numeric Bar Codes](#) for numeric bar codes.



*180



Image Brightness
(3 digits)

Image File Format Selector

Parameter # 304 (SSI # F0h 30h)

Select an image format appropriate for the system (BMP, TIFF, or JPEG). The imager stores captured images in the selected format.



BMP File Format
(3)



***JPEG File Format**
(1)



TIFF File Format
(4)

JPEG Image Options

Parameter # 299 (SSI # F0h 2Bh)

JPEG images can be optimized for either size or for quality. Scan the **Quality Selector** bar code to enter a quality value; the imager then selects the corresponding image size. Scan the **Size Selector** bar code to enter a size value; the imager then selects the best image quality.



***JPEG Quality Selector**
(1)



JPEG Size Selector
(0)

JPEG Quality and Size Value

JPEG Quality = Parameter # 305 (SSI # F0h 31h)

JPEG Size = Parameter # 561 (SSI # F1h 31h)

If you select JPEG Quality Selector, scan the **JPEG Quality Value** bar code followed by 3 bar codes from [Appendix D, Numeric Bar Codes](#) corresponding to a value from 5 to 100, where 100 represents the highest quality image.

If you select JPEG Size Selector, scan **JPEG Size Value** followed by 3 bar codes from [Appendix D, Numeric Bar Codes](#) corresponding to a value from 5 to 350 which represents the file size in multiples of 1024 bytes (1K). For example, setting this value to 8 (008) permits the file size to be as large as 8192 bytes. The default is 160 (164K).



JPEG Quality Value
(Default: 065)
(5 - 100 Decimal)



JPEG Size Value
(Default: 040)
(5 - 150 Decimal)

Image File Meta Data

Parameter # 693 (SSI # F1h B5h)

Enable this option to tag images transmitted in JPEG format with the following EXIF 2.2 standard data fields:

- Time (since power up)
- Sensor used
- Device name
- Manufacturer
- Frame rate
- Host type
- Image number (since power up)
- Image Enhancement parameter setting
- Image Edge Sharpening parameter setting
- Image Contrast Enhancement parameter setting.

This parameter has no effect on images transmitted in TIFF or BMP format.



**Enable Image File Meta Data
(1)**

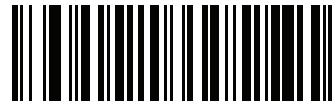

***Disable Image File Meta Data
(0)**

Image Enhancement

Parameter # 564 (SSI # F1h 34h)

This feature uses a combination of edge sharpening and contrast enhancement to produce an image that is visually pleasing. If you select **User**, also set the [Image Edge Sharpening on page 7-24](#) and [Image Contrast Enhancement on page 7-25](#) to enhance the image.

The levels of image enhancement are:

- Off (0) - Default
- Low (1)
- Med (2)
- High (3)
- User (4).

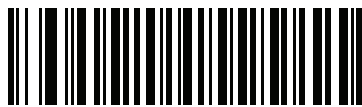

*Off
(0)



Low
(1)



Medium
(2)



High
(3)



User
(4)

Image Edge Sharpening

Parameter # 664 (SSI # F1h 98h)

This feature uses an edge sharpening technique, and only applies if you set the *Image Enhancement* parameter to **User**. To set this parameter, scan the **Image Edge Sharpening** bar code, followed by three numeric bar codes in *Appendix D, Numeric Bar Codes* that represent the image edge sharpening value. Alternatively, to set a recommended value, scan one of the value bar codes below.

Recommended settings are:

- Off (0)
- Low (30) - Default
- Med (75)
- High (100).

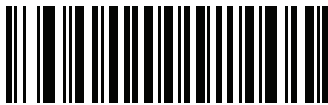

Image Edge Sharpening



**Off
(0)**



***Low
(30)**



**Medium
(75)**



**High
(100)**

Image Contrast Enhancement

Parameter # 666 (SSI # F1h 9Ah)

Enable this feature to enhance the contrast of an image. This parameter only applies if you set the *Image Enhancement* parameter to **User**.



***Disable**
(0)

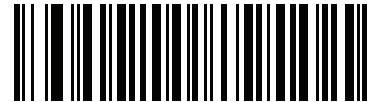

Enable
(1)

Image Rotation

Parameter # 665 (SSI # F1h 99h)

This parameter controls the rotation of the image by 0, 90, 180, or 270 degrees.



***Rotate 0°
(0)**



**Rotate 90°
(1)**

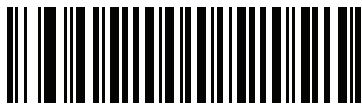

**Rotate 180°
(2)**

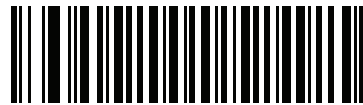

**Rotate 270°
(3)**

Bits per Pixel

Parameter # 303 (SSI # F0h 2Fh)

Select the number of significant bits per pixel (BPP) to use when capturing an image. Select 1 BPP for a black and white image, 4 BPP to assign 1 of 16 levels of grey to each pixel, or 8 BPP to assign 1 of 256 levels of grey to each pixel. The imager ignores these settings for JPEG files, which always use 8 BPP.



1 BPP
(0)



4 BPP
(1)



***8 BPP**
(2)

Signature Capture

Parameter # 93 (SSI # 5Dh)

A signature capture bar code is a special-purpose symbology which delineate a signature capture area in a document with a machine-readable format. The recognition pattern is variable so it can optionally provide an index to various signatures. The region inside the bar code pattern is considered the signature capture area.

Output File Format

Decoding a signature capture bar code de-skews the signature image and converts the image to a BMP, JPEG, or TIFF file format. The output data includes the file descriptor followed by the formatted signature image.

File Descriptor			Signature Image
Output Format (1 byte)	Signature Type (1 byte)	Signature Image Size (4 bytes) (BIG Endian)	
JPEG - 1 BMP - 3 TIFF - 4	1-8	0x00000400	0x00010203.....

To enable or disable Signature Capture, scan the appropriate bar code below.



**Enable Signature Capture
(1)**



***Disable Signature Capture
(0)**

Signature Capture File Format Selector

Parameter # 313 (SSI # F0h 39h)

Select a signature file format appropriate for the system (BMP, TIFF, or JPEG). The imager stores captured signatures in the selected format.



BMP Signature Format
(3)



***JPEG Signature Format**
(1)



TIFF Signature Format
(4)

Signature Capture Bits per Pixel

Parameter # 314 (SSI # F0h 3Ah)

Select the number of significant bits per pixel (BPP) to use when capturing a signature. Select 1 BPP for a black and white image, 4 BPP to assign 1 of 16 levels of grey to each pixel, or 8 BPP to assign 1 of 256 levels of grey to each pixel. The imager ignores these settings for JPEG files, which always use 8 BPP.



1 BPP
(0)



4 BPP
(1)



***8 BPP**
(2)

Signature Capture Width

Parameter # 366 (SSI # F4h F0h 6Eh)

The aspect ratio of the Signature Capture Width and Signature Capture Height parameters must match that of the signature capture area. For example, a 4 x 1 inch signature capture area requires a 4 to 1 aspect ratio of width to height.

To set the width of the signature capture box, scan the **Signature Capture Width** bar code, followed by 3 bar codes from [Appendix D, Numeric Bar Codes](#) corresponding to a value in the range of 040 to 752 decimal.



Signature Capture Width
(Default: 400)
(040- 752 Decimal)

Signature Capture Height

Parameter # 367 (SSI # F4h F0h 6Fh)

To set the height of the signature capture box, scan the **Signature Capture Height** bar code, followed by 3 bar codes from [Appendix D, Numeric Bar Codes](#) corresponding to a value in the range of 010 to 480 decimal.



Signature Capture Height (Default: 100)
(010 - 480 Decimal)

Signature Capture JPEG Quality

Parameter # 421 (SSI # F0h A5h)

Scan the **JPEG Quality Value** bar code followed by 3 bar codes from [Appendix D, Numeric Bar Codes](#) corresponding to a value from 005 to 100, where 100 represents the highest quality image.



JPEG Quality Value (Default: 065)
(5 - 100 Decimal)

Video Mode Format Selector

Parameter # 916 (SSI # F2h 94h)

When the imager is in Video Mode, select whether to send data in BMP or JPEG format.



BMP File Format
(3)



***JPEG File Format**
(1)

Video View Finder

Parameter # 324 (SSI # F0h 44h)

Select **Enable Video View Finder** to project the video view finder while in Image Mode, or **Disable Video View Finder** to turn the video view finder off.

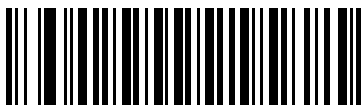

***Disable Video View Finder**
(0)

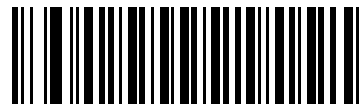

Enable Video View Finder
(1)

Target Video Frame Size

Parameter # 328 (SSI # F0h 48h)

Select the number of 100-byte blocks to transmit per second. Selecting a smaller value transmits more frames per second but reduces video quality; selecting a larger value increases video quality but slows transmission.

To set the Target Video Frame Size, scan the bar code below followed by two bar codes from [Appendix D, Numeric Bar Codes](#) corresponding to the 100-byte value from 800 to 20,000 bytes. For example, to select 1500 bytes, enter 1, 5. To select 900 bytes, enter 0, 9. The default is 2200 bytes.



Target Video Frame Size

Video View Finder Image Size

Parameter # 329 (SSI # F0h 49h)

Select the number of 100-byte blocks. Values range from 800 to 12,000 bytes. Selecting a smaller value transmits more frames per second; selecting a larger value increases video quality.

To set the Video View Finder Imager Size, scan the bar code below followed by two bar codes from [Appendix D, Numeric Bar Codes](#) corresponding to the 100-byte value from 800 to 12,000 bytes. For example, to select 1500 bytes, enter 1, 5. To select 900 bytes, enter 0, 9. The default is 1700 bytes.



Video View Finder Image Size

Video Resolution

Parameter # 667 (SSI # F1h 9Bh)

This parameter alters the video resolution before transmission. Rows and columns are removed from the image, resulting in a smaller video image containing the original content with reduced resolution.

Select one of the following values:

Resolution Value	Video Image Size
Full	752 x 480
1/2	376 x 240
1/4	188 x 120



**Full Resolution
(0)**



**1/2 Resolution
(1)**



***1/4 Resolution
(3)**

CHAPTER 8 SSI INTERFACE

Introduction

This chapter describes the system requirements of the Simple Serial Interface (SSI), which provides a communications link between Zebra decoders (e.g., scan engines, imagers, hand-held scanners, two-dimensional scanners, hands-free scanners, and RF base stations) and a serial host. It provides the means for the host to control the imager.

Communications

All communication between the imager and host occurs over the hardware interface lines using the SSI protocol. Refer to the *Simple Serial Interface Programmer's Guide*, p/n 72-40451-xx, for more information on SSI.

The host and the imager exchange messages in packets. A packet is a collection of bytes framed by the proper SSI protocol formatting bytes. The maximum number of bytes per packet that the SSI protocol allows for any transaction is 257 (255 bytes + 2 byte checksum).

Decode data can be sent as ASCII data (unpacketed), or as part of a larger message (packeted), depending on the imager configuration.

SSI performs the following functions for the host device:

- Maintains a bi-directional interface with the imager
- Allows the host to send commands that control the imager
- Passes data from the imager to a host device in SSI packet format or straight decode message.

The working environment of the SSI consists of an imager, a serial cable which attaches to the host device, and in some instances, a power supply.

SSI transmits all decode data including special formatting (e.g., AIM ID). Parameter settings can control the format of the transmitted data.

The imager can also send parameter information, product identification information, or event codes to the host.

All commands sent between the imager and host must use the format described in the SSI Message Formats section. [SSI Transactions on page 8-3](#) describes the required sequence of messages in specific cases.

Table 8-1 lists all the SSI opcodes the imager supports. It identifies the SSI partner allowed to send a message of each type. The host transmits opcodes designated type H. The imager transmits type D opcodes, and either partner can transmit Host/Decoder (H/D) types.

Table 8-1 SSI Commands

Name	Type	Opcode	Description
AIM_OFF	H	0xC4	Deactivate aim pattern.
AIM_ON	H	0xC5	Activate aim pattern.
BEEP	H	0xE6	Sound the beeper.
CAPABILITIES_REPLY	D	0xD4	Reply to CAPABILITIES_REQUEST; contains a list of the capabilities and commands the imager supports.
CAPABILITIES_REQUEST	H	0xD3	Request capabilities report from the imager.
CMD_ACK	H/D	0xD0	Positive acknowledgment of received packet.
CMD_NAK	H/D	0xD1	Negative acknowledgment of received packet.
DECODE_DATA	D	0xF3	Decode data in SSI packet format.
EVENT	D	0xF6	Event indicated by associated event code.
LED_OFF	H	0xE8	De-activate LED output.
LED_ON	H	0xE7	Activate LED output.
PARAM_DEFAULTS	H	0xC8	Set parameter default values.
PARAM_REQUEST	H	0xC7	Request values of certain parameters.
PARAM_SEND	H/D	0xC6	Send parameter values.
REPLY_ID	D	0xA6	Reply to REQUEST_ID; contains imager's serial number.
REPLY_REVISION	D	0xA4	Reply to REQUEST_REVISION contains imager's software/hardware configuration.
REQUEST_ID	H	0xA3	Request the imager's serial number.
REQUEST_REVISION	H	0xA3	Request the imager's configuration.
SCAN_DISABLE	H	0xEA	Prevent the operator from scanning bar codes.
SCAN_ENABLE	H	0xE9	Permit bar code scanning.
SLEEP	H	0xEB	Request to place the imager into low power.
START_DECODE	H	0xE4	Tell imager to attempt to decode a bar code.
STOP_DECODE	H	0xE5	Tell imager to abort a decode attempt.
WAKEUP	H	N/A	Wake up imager after it has entered low power mode.

For details of the SSI protocol, refer to the *Simple Serial Interface Programmer's Guide* (72-40451-xx).

SSI Transactions

General Data Transactions

ACK/NAK Handshaking

If you enable ACK/NAK handshaking, all packeted messages must have a CMD_ACK or CMD_NAK response, unless the command description states otherwise. This parameter is enabled by default. Zebra recommends leaving this handshaking enabled to provide feedback to the host. Raw decode data and WAKEUP do not use ACK/NAK handshaking since they are not packeted data.

Following is an example of a problem which can occur if you disable ACK/NAK handshaking:

- The host sends a PARAM_SEND message to the imager to change the baud rate from 9600 to 19200.
- The imager cannot interpret the message.
- The imager does not implement the change the host requested.
- The host assumes that the parameter change occurred and acts accordingly.
- Communication is lost because the change did not occur on both sides.

If you enable ACK/NAK handshaking, the following occurs:

- The host sends a PARAM_SEND message.
- The imager cannot interpret the message.
- The imager CMD_NAKs the message.
- The host resends the message.
- The imager receives the message successfully, responds with CMD_ACK, and implements parameter changes.

Transfer of Decode Data

The Decode Data Packet Format parameter controls how decode data is sent to the host. Set this parameter to send the data in a DECODE_DATA packet. Clear this parameter to transmit the data as raw ASCII data.

✓ **NOTE** When transmitting decode data as raw ASCII data, ACK/NAK handshaking does not apply regardless of the state of the ACK/NAK handshaking parameter.

ACK/NAK Enabled and Packeted Data

The imager sends a DECODE_DATA message after a successful decode. The imager waits for a programmable time-out for a CMD_ACK response. If it does not receive the response, the imager tries to send two more times before issuing a host transmission error. If the imager receives a CMD_NAK from the host, it may attempt a retry depending on the cause field of the CMD_NAK message.

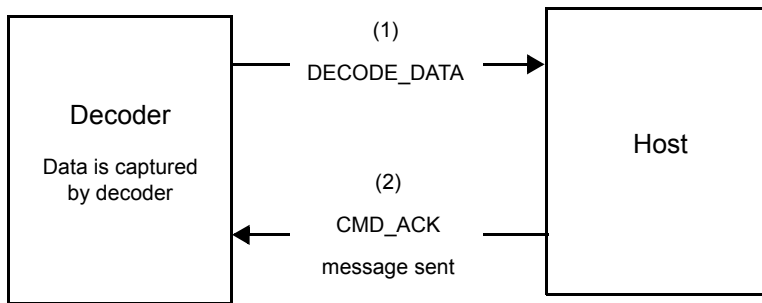

ACK/NAK Enabled and Unpacketed ASCII Data

Even though the ACK/NAK handshaking is enabled, no handshaking occurs because the handshaking applies only to packeted data. In this example the **packeted_decode** parameter is disabled.

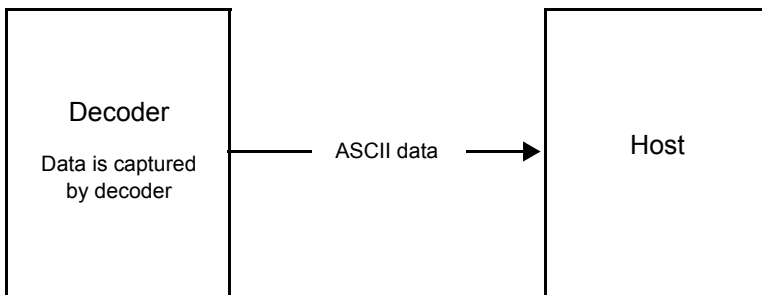

ACK/NAK Disabled and Packeted DECODE_DATA

In this example ACK/NAK does not occur even though **packeted_decode** is enabled because the ACK/NAK handshaking parameter is disabled.

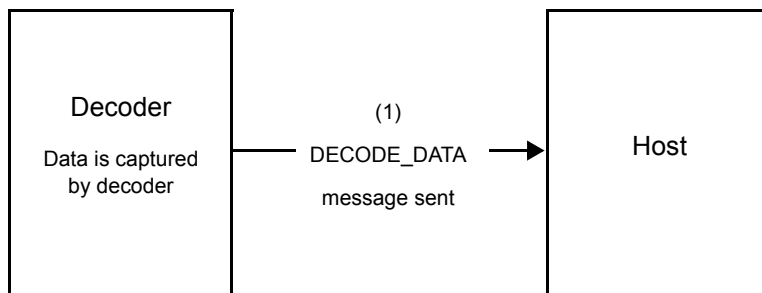

ACK/NAK Disabled and Unpacketed ASCII Data

Data captured by the imager is sent to the host.

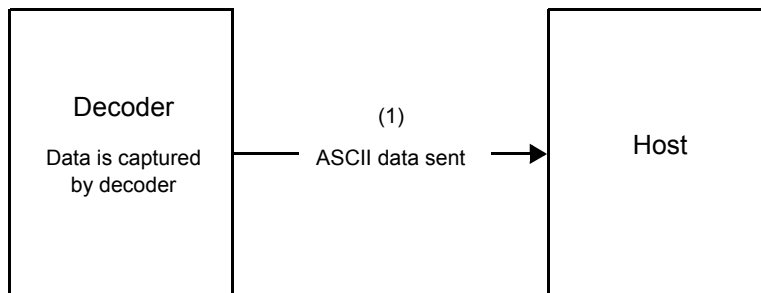

Communication Summary

RTS/CTS Lines

All communication must use RTS/CTS handshaking as described in the *Simple Serial Interface Programmer's Guide*, p/n 72-40451-xx. If hardware handshaking is disabled or bypassed, the WAKEUP command must be sent prior to all other communications, or the first byte of a communication message may be lost during the imager wakeup sequence.

ACK/NAK Option

Enable or disable ACK/NAK handshaking. This handshaking is enabled by default and Zebra recommends leaving it enabled. Disabling this handshaking can cause communication problems, as handshaking is the only acknowledgment that a message was received, and if it was received correctly. ACK/NAK is not used with unpacketed decode data regardless of whether or not it is enabled.

Number of Data Bits

All communication with the imager must use 8-bit data.

Serial Response Time-out

The Serial Response Time-out parameter determines how long to wait for a handshaking response before trying again, or aborting any further attempts. Set the same value for both the host and imager.

- ✓ **NOTE** You can temporarily change the Serial Response Time-out when the host takes longer to process an ACK or longer data string. Zebra does not recommend frequent permanent changes due to limited write cycles of non-volatile memory.

Retries

When sending data, the host should resend twice after the initial send if the imager does not respond with an ACK or NAK (if ACK/NAK handshaking is enabled), or response data (e.g., PARAM_SEND, REPLY_REVISION). If the imager replies with a NAK RESEND, the host resends the data. All resent messages must have the resend bit set in the Status byte.

The imager resends data two times after the initial send if the host fails to reply with an ACK or NAK (if ACK/NAK handshaking is enabled).

Baud Rate, Stop Bits, Parity, Response Time-out, ACK/NAK Handshake

If you use PARAM_SEND to change these serial parameters, the ACK response to the PARAM_SEND uses the previous values for these parameters. The new values then take effect for the next transaction.

Errors

The imager issues a communication error when:

- The CTS line is asserted when the imager tries to transmit, and is still asserted on each of 2 successive retries
- Failure to receive an ACK or NAK after initial transmit and two resends.

Things to Remember When Using SSI Communication

When not using hardware handshaking, space messages sufficiently apart. The host must not communicate with the imager if the imager is transmitting.

When using hardware handshaking, frame each message properly with the handshaking signals. Do not try to send two commands within the same handshaking frame.

There is a permanent/temporary bit in the PARAM_SEND message. Removing power from the imager discards temporary changes. Permanent changes are written to non-volatile memory. Frequent changes shorten the life of the non-volatile memory.

Using Time Delay to Low Power Mode with SSI

[Time Delay to Low Power Mode on page 6-17](#) provides bar codes to select a general time delay. To program a more specific delay value, use an SSI command according to [Table 8-2](#).

Table 8-2 Values for Selecting Time Delay to Low Power

Value	Timeout	Value	Timeout	Value	Timeout	Value	Timeout
0x00	15 Mins	0x10	1 Sec	0x20	1 Min	0x30	1 Hour
0x01	30 Mins	0x11	1 Sec	0x21	1 Min	0x31	1 Hour
0x02	60 Mins	0x12	2 Secs	0x22	2 Mins	0x32	2 Hours
0x03	90 Mins	0x13	3 Secs	0x23	3 Mins	0x33	3 Hours
N/A	N/A	0x14	4 Secs	0x24	4 Mins	0x34	4 Hours
N/A	N/A	0x15	5 Secs	0x25	5 Mins	0x35	5 Hours
N/A	N/A	0x16	6 Secs	0x26	6 Mins	0x36	6 Hours
N/A	N/A	0x17	7 Secs	0x27	7 Mins	0x37	7 Hours
N/A	N/A	0x18	8 Secs	0x28	8 Mins	0x38	8 Hours
N/A	N/A	0x19	9 Secs	0x29	9 Mins	0x39	9 Hours
N/A	N/A	0x1A	10 Secs	0x2A	10 Mins	0x3A	10 Hours
N/A	N/A	0x1B	15 Secs	0x2B	15 Mins	0x3B	15 Hours
N/A	N/A	0x1C	20 Secs	0x2C	20 Mins	0x3C	20 Hours
N/A	N/A	0x1D	30 Secs	0x2D	30 Mins	0x3D	30 Hours
N/A	N/A	0x1E	45 Secs	0x2E	45 Mins	0x3E	45 Hours
N/A	N/A	0x1F	60 Secs	0x2F	60 Mins	0x3F	60 Hours



CAUTION With hardware handshaking disabled, the DS457 wakes from low power mode upon receiving a character. However, the DS457 does not process this character or any others it receives during the 7 ms period following wakeup. Wait at least 7 ms after wakeup to send valid characters.

Simple Serial Interface Default Parameters

This section describes how to set up the imager with an SSI host. When using SSI, program the imager via bar code menu or hosts commands.

Throughout the programming bar code menus, asterisks (*) indicate default values.



- ✓ **NOTE** Most computer monitors allow scanning the bar codes directly on the screen. When scanning from the screen, be sure to set the document magnification to a level where you can see the bar code clearly, and bars and/or spaces are not merging.

Table 8-3 lists the defaults for the SSI host. There are two ways to change the default values:

- Scan the appropriate bar codes in this guide. These new values replace the standard default values in memory. To recall the default parameter values, scan the [*Restore Defaults](#) bar code on [page 6-5](#).
- Download data through the device's serial port using SSI. Hexadecimal parameter numbers appear in this chapter below the parameter title, and options appear in parenthesis beneath the accompanying bar codes. Refer to the *Simple Serial Interface (SSI) Programmer's Guide* for detailed instructions for changing parameters using this method.

- ✓ **NOTE** See [Appendix A, Standard Default Parameters](#) for all user preferences, hosts, symbologies, and miscellaneous default parameters.

Table 8-3 SSI Default Table

Parameter	Parameter Number	SSI Number	Default	Page Number
Select SSI Host	N/A	N/A	N/A	8-9
Baud Rate	156	9Ch	9600	8-10
Parity	258	9Eh	None	8-11
Check Parity	151	97h	Disable	8-12
Software Handshaking	159	9Fh	ACK/NAK	8-12
Host RTS Line State	154	9Ah	Low	8-13
Decode Data Packet Format	238	EEh	Send Raw Decode Data	8-13
Host Serial Response Time-out	155	9Bh	2 sec	8-14
Host Character Time-out	239	EFh	200 msec	8-15

Table 8-3 SSI Default Table (Continued)

Parameter	Parameter Number	SSI Number	Default	Page Number
Multipacket Option	334	F0h 4Eh	Option 1	8-16
Interpacket Delay	335	F0h 4Fh	0 ms	8-17
Event Reporting				
Decode Event	256	F0h 00h	Disable	8-18
Boot Up Event	258	F0h 02h	Disable	8-19
Parameter Event	259	F0h 03h	Disable	8-19



NOTE SSI interprets Prefix, Suffix1, and Suffix2 values listed in [Table E-1 on page E-1](#) differently than other interfaces. SSI does not recognize key categories, only the 3-digit decimal value. The default value of 7013 is interpreted as CR only.

SSI Host Parameters

Select SSI Host

To select SSI as the host interface, scan the following bar code.



SSI Host

Baud Rate

Parameter # 156 (SSI # 9Ch)

Baud rate is the number of bits of data transmitted per second. Set the imager's baud rate to match the baud rate setting of the host device. Otherwise, data may not reach the host device or may reach it in distorted form.



***Baud Rate 9600
(6)**



**Baud Rate 19,200
(7)**



**Baud Rate 38,400
(8)**



**Baud Rate 57,600
(10)**



**Baud Rate 115,200
(11)**



**Baud Rate 230,400
(13)**

Baud Rate (continued)



Baud Rate 460,800
(14)



Baud Rate 921,600
(15)

Parity

Parameter # 258 (SSI # 9Eh)

A parity check bit is the most significant bit of each ASCII coded character. Select the parity type according to host device requirements.

- Select **Odd** parity and the parity bit has a value 0 or 1, based on data, to ensure that an odd number of 1 bits is contained in the coded character.
- Select **Even** parity and the parity bit has a value 0 or 1, based on data, to ensure that an even number of 1 bits is contained in the coded character.
- If no parity is required, select **None**.



Odd
(0)



Even
(1)



***None**
(4)

Check Parity

Parameter # 151 (SSI # 97h)

Select whether or not to check the parity of received characters. Use the Parity parameter to select the type of parity.



***Do Not Check Parity
(0)**



**Check Parity
(1)**

Software Handshaking

Parameter # 159 (SSI # 9Fh)

This parameter offers control of data transmission in addition to the control hardware handshaking offers. Hardware handshaking is always enabled; you cannot disable it.

- **Disable ACK/NAK Handshaking:** When this option is selected, the imager neither generates nor expects ACK/NAK handshaking packets.
- **Enable ACK/NAK Handshaking:** When this option is selected, after transmitting data, the imager expects either an ACK or NAK response from the host. The imager also ACKs or NAKs messages from the host.

The imager waits up to the programmable Host Serial Response Time-out to receive an ACK or NAK. If the imager does not get a response in this time, it resends its data up to two times before discarding the data and declaring a transmit error.



**Disable ACK/NAK
(0)**



***Enable ACK/NAK
(1)**

Host RTS Line State

Parameter # 154 (SSI # 9Ah)

This parameter sets the expected idle state of the Serial Host RTS line.

The SSI Interface is used with host applications which also implement the SSI protocol. However, you can use the imager in a "scan-and-transmit" mode to communicate with any standard serial communication software on a host PC (see [Decode Data Packet Format on page 8-13](#)). If transmission errors occur in this mode, the host PC may be asserting hardware handshaking lines which interfere with the SSI protocol. Scan the **Host: RTS High** bar code to address this problem.



***Host: RTS Low
(0)**



**Host: RTS High
(1)**

Decode Data Packet Format

Parameter # 238 (SSI # EEh)

This parameter selects whether to transmit decoded data in raw format (unpacketed), or with the packet format defined by the serial protocol.

Selecting the raw format disables ACK/NAK handshaking for decode data.



***Send Raw Decode Data
(0)**



**Send Packeted Decode Data
(1)**

Host Serial Response Time-out

Parameter # 155 (SSI # 9Bh)

This parameter specifies how long the imager waits for an ACK or NAK before resending. Also, if the imager wants to send, and the host has already been granted permission to send, the imager waits for the designated time-out before declaring an error.

To set the delay period (options are 2, 5, 7.5, or 9.9 seconds), scan one of the following bar codes.

✓ **NOTE** Other values are available via SSI command.



***Low - 2 Seconds
(20)**



**Medium - 5 Seconds
(50)**



**High - 7.5 Seconds
(75)**



**Maximum - 9.9 Seconds
(99)**

Host Character Time-out

Parameter # 239 (SSI # EFh)

This parameter determines the maximum time the imager waits between characters transmitted by the host before discarding the received data and declaring an error.

To set the delay period (options are 200, 500, 750, or 990 ms), scan one of the following bar codes.

✓ **NOTE** Other values are available via SSI command.



***Low - 200 ms**
(20)



Medium - 500 ms
(50)



High - 750 ms
(75)



Maximum - 990 ms
(99)

Multipacket Option

Parameter # 334 (SSI # F0h, 4Eh)

This parameter controls ACK/NAK handshaking for multi-packet transmissions.

- **Multi-Packet Option 1:** The host sends an ACK / NAK for each data packet during a multi-packet transmission.
- **Multi-Packet Option 2:** The imager sends data packets continuously, with no ACK/NAK handshaking to pace the transmission. The host, if overrun, can use hardware handshaking to temporarily delay imager transmissions. At the end of transmission, the imager waits for a CMD_ACK or CMD_NAK.
- **Multi-Packet Option 3:** Option 3 is the same as option 2 with the addition of a programmable interpacket delay.



***Multipacket Option 1
(0)**



**Multipacket Option 2
(1)**



**Multipacket Option 3
(2)**

Interpacket Delay

Parameter # 335 (SSI # F0h, 4Fh)

This parameter specifies the interpacket delay if you selected **Multipacket Option 3**.

To set the delay period (options are 0, 25, 50, 75, or 99 ms), scan one of the following bar codes.

✓ **NOTE** Other values are available via SSI command.



*Minimum - 0 ms
(0)



Low - 25 ms
(25)



Medium - 50 ms
(50)



High - 75 ms
(75)



Maximum - 99 ms
(99)

Event Reporting

The host can request the imager to provide certain information (events) relative to the imager's behavior. Enable or disable the events listed in [Table 8-4](#) and on the following pages by scanning the appropriate bar codes.

Table 8-4 *Event Codes*

Event Class	Event	Code Reported
Decode Event	Non parameter decode	0x01
Boot Up Event	System power-up	0x03
Parameter Event	Parameter entry error	0x07
	Parameter stored	0x08
	Defaults set (and parameter event is enabled by default)	0x0A
	Number expected	0x0F

Decode Event

Parameter # 256 (SSI # F0h, 00h)

When enabled, the imager generates a message to the host upon a successful bar code decode. When disabled, no notification is sent.

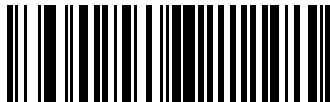

Enable Decode Event
(1)

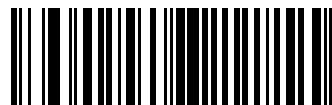

***Disable Decode Event**
(0)

Boot Up Event

Parameter # 258 (SSI # F0h, 02h)

When enabled, the imager generates a message to the host whenever power is applied. When disabled, no notification is sent.

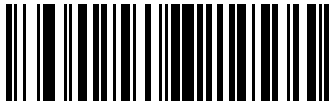

Enable Boot Up Event
(1)

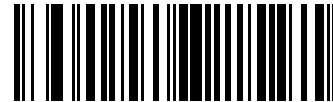

*Disable Boot Up Event
(0)

Parameter Event

Parameter # 259 (SSI # F0h, 03h)

When enabled, the imager generates a message to the host when one of the events specified in [Table 8-4 on page 8-18](#) occurs. When disabled, no notification is sent.

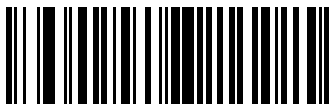

Enable Parameter Event
(1)



*Disable Parameter Event
(0)

CHAPTER 9 SERIAL INTERFACE

Introduction

This chapter describes how to set up the imager with a serial host. The serial interface connects the imager to point-of-sale devices, host computers, or other devices with an available serial port (e.g., com port).

If the host is not listed in [Table 9-2](#), refer to the documentation for the host device to set communication parameters to match the host.

- ✓ **NOTE** The imager uses TTL signal levels, which interface with most system architectures. System architectures that use RS-232C signal levels require conversion circuitry.

Throughout the programming bar code menus, asterisks (*) indicate default values.



* Indicates Default ——— ***Baud Rate 57,600**——— Feature/Option

- ✓ **NOTE** The [SSI Host on page 8-9](#) is automatically selected when a serial cable is attached. To select another RS-232 host, select one of the [Serial Host Types on page 9-5](#), and then scan other bar code menus in this chapter as part of initial configuration.

Most computer monitors allow scanning the bar codes directly on the screen. When scanning from the screen, be sure to set the document magnification to a level where you can see the bar code clearly, and bars and/or spaces are not merging.



- CAUTION** The DS457 wakes from low power mode upon receiving a character. However, the DS457 does not process this character or any others it receives during the 7 ms period following wakeup. Wait at least 7 ms after wakeup to send valid characters.

Serial Parameter Defaults

Table 9-1 lists the defaults for serial host parameters. To change any option, scan the appropriate bar code(s) provided in the Serial Host Parameters section beginning on [page 9-3](#).

✓ **NOTE** See [Appendix A, Standard Default Parameters](#) for all user preferences, hosts, symbologies, and miscellaneous default parameters.

Table 9-1 *Serial Host Default Table*

Parameter	Default	Page Number
Serial Host Parameters		
Serial Host Types	Standard RS-232	9-5
Baud Rate	9600	9-7
Parity Type	None	9-9
Data Bits	8-Bit	9-9
Check Receive Errors	Enable	9-10
Hardware Handshaking	None	9-11
Software Handshaking	None	9-13
Host Serial Response Time-out	2 Sec	9-15
RTS Line State	Low RTS	9-16
Beep on <BEL>	Disable	9-16
Intercharacter Delay	0 msec	9-17
Nixdorf Beep/LED Options	Normal Operation	9-18
Ignore Unknown Characters	Send Bar Code	9-18

Serial Host Parameters

Various serial hosts use their own parameter default settings. Selecting standard, ICL, Fujitsu, Wincor-Nixdorf Mode A, Wincor-Nixdorf Mode B, OPOS/JPOS, Olivetti, Omron, or Common Use Terminal Equipment (CUTE-LP/LG bar code readers) sets the defaults listed in [Table 9-2](#).

Table 9-2 Terminal-Specific Serial Defaults

Parameter	ICL	Fujitsu	Wincor-Nixdorf Mode A	Wincor-Nixdorf Mode B/ OPOS/JPOS	Olivetti	Omron	CUTE
Transmit Code ID	Yes	Yes	Yes	Yes	Yes	Yes	
Data Transmission Format	Data/Suffix	Data/Suffix	Data/Suffix	Data/Suffix	Prefix/Data/Suffix	Data/Suffix	Prefix//Data/Suffix
Prefix	None	None	None	None	STX (1003)	None	STX (1002)
Suffix	CR (1013)	CR (1013)	CR (1013)	CR (1013)	ETX (1002)	CR (1013)	CR (1013) ETX (1003)
Baud Rate	9600	9600	9600	9600	9600	9600	9600
Parity	Even	None	Odd	Odd	Even	None	Even
ASCII Format	8-Bit	8-Bit	8-Bit	8-Bit	7-Bit	8-Bit	7-Bit
Hardware Handshaking	RTS/CTS Option 3	None	RTS/CTS Option 3	RTS/CTS Option 3	None	None	None
Software Handshaking	None	None	None	None	ACK/NAK	None	None
Serial Response Time-out	9.9 Sec.	2 Sec.	9.9 Sec.	9.9 Sec.	9.9 Sec.	9.9 Sec.	9.9 Sec.
RTS Line State	High	Low	Low	Low = No data to send	Low	High	High
Beep On <BEL>	Disable	Disable	Disable	Disable	Disable	Disable	Disable

***In Nixdorf Mode B, if CTS is low, scanning is disabled. When CTS is high, scanning is enabled.**
****If Nixdorf Mode B is scanned without the imager connected to the proper host, it may appear unable to scan. If this happens, scan a different serial host type within 5 seconds of cycling power to the imager.**
The CUTE host disables all parameter scanning, including Set Defaults. If you inadvertently select CUTE, scan **Enable Parameter Scanning (1)* on page 6-6, then change the host selection.

Serial Host Parameters (continued)

Selecting ICL, Fujitsu, Wincor-Nixdorf Mode A, Wincor-Nixdorf Mode B, OPOS/JPOS, Olivetti, Omron, or Common Use Terminal Equipment (CUTE-LP/LG bar code readers) enables the transmission of code ID characters listed in [Table 9-3](#). These code ID characters are not programmable and are separate from the Transmit Code ID feature. Do not enable the Transmit Code ID feature for these terminals.

Table 9-3 Terminal Specific Code ID Characters

Code Type	ICL	Fujitsu	Wincor-Nixdorf Mode A	Wincor-Nixdorf Mode B/ OPOS/JPOS	Olivetti	Omron	CUTE
UPC-A	A	A	A	A	A	A	A
UPC-E	E	E	C	C	C	E	None
EAN-8/JAN-8	FF	FF	B	B	B	FF	None
EAN-13/JAN-13	F	F	A	A	A	F	A
Bookland EAN	F	F	A	A	A	F	None
Code 39	C <len>	None	M	M	M <len>	C <len>	3
Code 39 Full ASCII	None	None	M	M	None	None	3
Trioptic	None	None	None	None	None	None	None
Code 32	None	None	None	None	None	None	None
Codabar	N <len>	None	N	N	N <len>	N <len>	None
Code 128	L <len>	None	K	K	K <len>	L <len>	5
GS1-128	L <len>	None	P	P	P <len>	L <len>	5
Code 93	None	None	L	L	L <len>	None	None
I 2 of 5	I <len>	None	I	I	I <len>	I <len>	1
D 2 of 5	H <len>	None	H	H	H <len>	H <len>	2
MSI	None	None	O	O	O <len>	None	None
Code 11	None	None	None	None	None	None	None
IATA	H<len>	None	H	H	H<len>	H<len>	2
GS1 Databar Variants	None	None	E	E	None	None	None
PDF417	None	None	Q	Q	None	None	6
MicroPDF417	None	None	S	S	None	None	6
Data Matrix	None	None	R	R	None	None	4
Maxicode	None	None	T	T	None	None	None
QR Codes	None	None	U	U	None	None	7
Aztec/Aztec Rune	None	None	V	V	None	None	8

Serial Host Types

To select a serial host interface, scan one of the following bar codes.

- ✓ **NOTE** Scanning **Standard RS-232** activates the serial driver, but does not change port settings (e.g., parity, data bits, handshaking). Selecting another serial host type bar code changes these settings.
- ✓ **NOTE** Selecting one of the [Serial Host Types](#) disables SSI support. To restore SSI support, scan [SSI Host on page 8-9](#).
- ✓ **NOTE** The CUTE host disables all parameter scanning, including Set Defaults. If you inadvertently select CUTE, scan [*Enable Parameter Scanning \(1\) on page 6-6](#), then change the host selection.

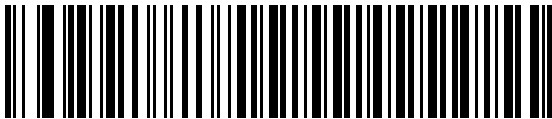

***Standard RS-232**

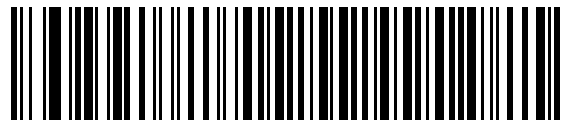

ICL Serial

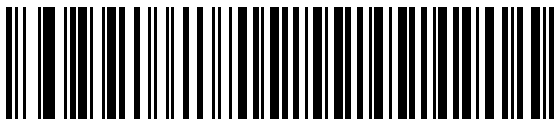

Wincor-Nixdorf Serial Mode A

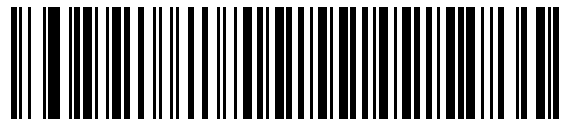

Wincor-Nixdorf Serial Mode B

Serial Host Types (continued)

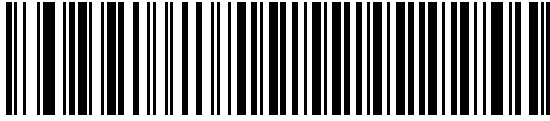

Olivetti ORS450

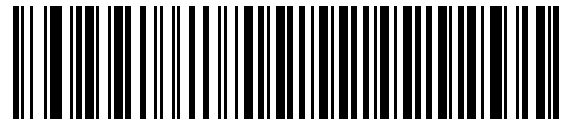

Omron

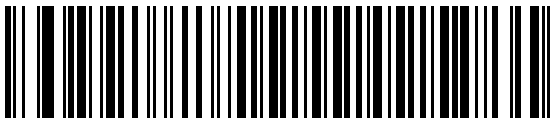

OPOS/JPOS

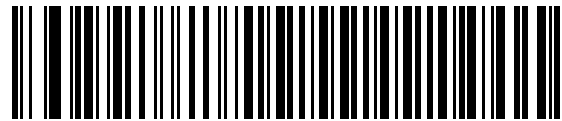

Fujitsu Serial

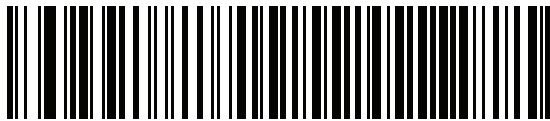

CUTE

Baud Rate

Baud rate is the number of bits of data transmitted per second. Set the imager's baud rate to match the baud rate setting of the host device. Otherwise, data may not reach the host device or may reach it in distorted form.



***Baud Rate 9600**



Baud Rate 19,200



Baud Rate 38,400



Baud Rate 57,600



Baud Rate 115,200



Baud Rate 230,400

Baud Rate (continued)



Baud Rate 460,800



Baud Rate 921,600

Parity

A parity check bit is the most significant bit of each ASCII coded character. Select the parity type according to host device requirements.

- Select **Odd** parity to set the parity bit value to 0 or 1, based on data, to ensure that an odd number of 1 bits are contained in the coded character.
- Select **Even** parity to set the parity bit value to 0 or 1, based on data, to ensure that an even number of 1 bits are contained in the coded character.
- Select **None** when no parity bit is required.

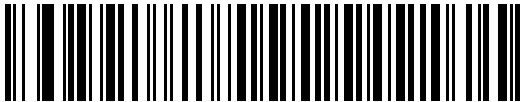

Odd

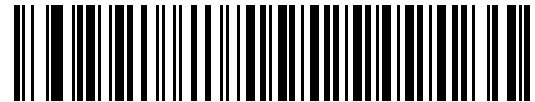

Even



*None

Data Bits

This parameter allows the imager to interface with devices requiring a 7-bit or 8-bit ASCII protocol.

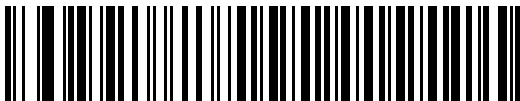

7-Bit



*8-Bit

Check Receive Errors

Select whether or not to check the parity, framing, and overrun of received characters. The parity value of received characters is verified against the setting of [Parity on page 9-9](#).



***Check For Received Errors**



Do Not Check For Received Errors

Hardware Handshaking

The data interface consists of a serial port designed to operate either with or without the hardware handshaking lines *Request to Send (RTS)* and *Clear to Send (CTS)*.

If Standard RTS/CTS handshaking is not selected, scan data transmits as it becomes available. Select Standard RTS/CTS handshaking to transmit scan data according to the following sequence:

- The imager reads the CTS line for activity. If CTS is asserted, the imager waits up to the Host Serial Response Time-out for the host to de-assert the CTS line. If, after the Host Serial Response Time-out (default) the CTS line is still asserted, the imager sounds a transmit error and discards any scanned data.
- When the CTS line is de-asserted, the imager asserts the RTS line and waits up to the Host Serial Response Time-out for the host to assert CTS. When the host asserts CTS, data transmits. If, after the Host Serial Response Time-out (default) the CTS line is not asserted, the imager sounds a transmit error and discards the data.
- When data transmission completes, the imager de-asserts RTS 10 msec after sending the last character.
- The host responds by negating CTS. The imager checks for a de-asserted CTS upon the next transmission of data.

During data transmission, the CTS line should be asserted. If CTS is deasserted for more than 50 ms between characters, the imager aborts transmission, sounds a transmission error, and discards the data.

If the above communication sequence fails, the imager issues an error indication. In this case, the data is lost and must be rescanned.

If hardware handshaking and software handshaking are both enabled, hardware handshaking takes precedence.

✓ **NOTE** The DTR signal is jumpered to the active state.

- **None:** Scan this bar code to disable hardware handshaking.
- **Standard RTS/CTS:** Scan this bar code to select Standard RTS/CTS Hardware Handshaking.
- **RTS/CTS Option 1:** The imager asserts RTS before transmitting and ignores the state of CTS. The imager de-asserts RTS when transmission completes.
- **RTS/CTS Option 2:** RTS is always high or low (user-programmed logic level). However, the imager waits for CTS to be asserted before transmitting data. If CTS is not asserted within Host Serial Response Time-out (default), the imager issues an error indication and discards the data.
- **RTS/CTS Option 3:** The imager asserts RTS prior to any data transmission, regardless of the state of CTS. The imager waits up to Host Serial Response Time-out (default) for CTS to be asserted. If CTS is not asserted during this time, the imager issues an error indication and discards the data. The imager de-asserts RTS when transmission completes.

Hardware Handshaking (continued)

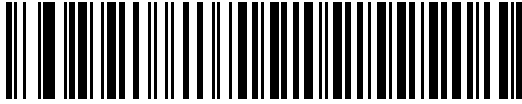

***None**

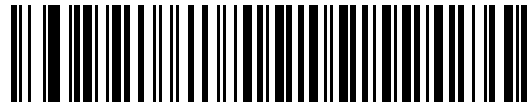

Standard RTS/CTS

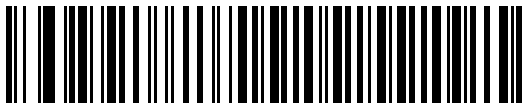

RTS/CTS Option 1



RTS/CTS Option 2

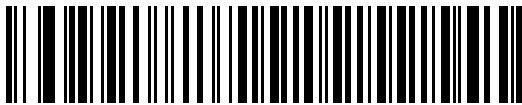

RTS/CTS Option 3

Software Handshaking

This parameter offers control of data transmission in addition to, or instead of, the control hardware handshaking offers. There are five options.

If software handshaking and hardware handshaking are both enabled, Hardware Handshaking takes precedence.

- **None:** Data transmits immediately. No response is expected from host.
- **ACK/NAK:** After transmitting data, the imager expects either an ACK or NAK response from the host. When the imager receives a NAK, it transmits the same data again and waits for either an ACK or NAK. After three unsuccessful attempts to send data when NAKs are received, the imager issues an error indication and discards the data.

The imager waits up to the programmable Host Serial Response Time-out to receive an ACK or NAK. If the imager does not receive a response in this time, it issues an error indication and discards the data. There are no retries when a time-out occurs.

- **ENQ:** The imager waits for an ENQ character from the host before transmitting data. If the imager does not receive an ENQ within the Host Serial Response Time-out, it issues an error indication and discards the data. The host must transmit an ENQ character at least every Host Serial Response Time-out to prevent transmission errors.
- **ACK/NAK with ENQ:** This combines the two previous options. For re-transmissions of data due to a NAK from the host, an additional ENQ is not required.
- **XON/XOFF:** An XOFF character turns the imager transmission off until the imager receives an XON character. There are two situations for XON/XOFF:
 - The imager receives an XOFF before it has data to send. When the imager has data to send, it waits up to the Host Serial Response Time-out for an XON character before transmission. If it does not receive an XON within this time, the imager issues an error indication and discards the data.
 - The imager receives an XOFF during a transmission. Data transmission then stops after sending the current byte. When the imager receives an XON character, it sends the rest of the data message. The imager waits indefinitely for the XON.

Software Handshaking (continued)

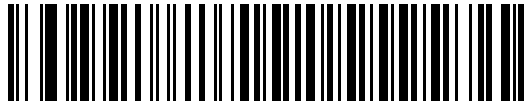

***None**

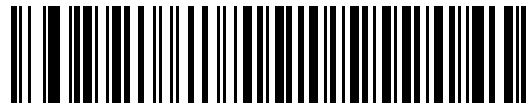

ACK/NAK

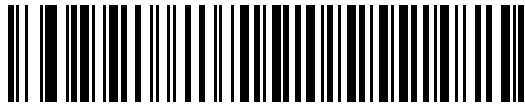

ENQ

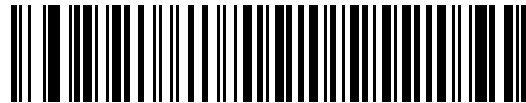

ACK/NAK with ENQ



XON/XOFF

Host Serial Response Time-out

This parameter specifies how long the imager waits for an ACK, NAK, or CTS before determining that a transmission error occurred. This only applies when in one of the ACK/NAK software handshaking modes, or RTS/CTS hardware handshaking mode.



***Minimum: 2 Sec**

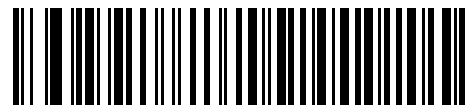

Low: 2.5 Sec

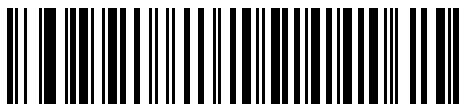

Medium: 5 Sec

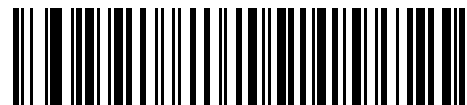

High: 7.5 Sec

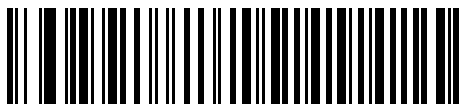

Maximum: 9.9 Sec

RTS Line State

This parameter sets the idle state of the Serial Host RTS line. Scan a bar code below to select **Low RTS** or **High RTS** line state.



*Host: Low RTS



Host: High RTS

Beep on <BEL>

When this parameter is enabled, the imager issues a beep when it detects a <BEL> character on the serial line. <BEL> gains a user's attention to an illegal entry or other important event.

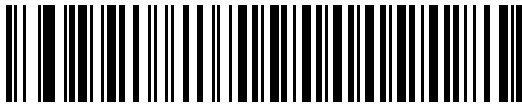

Beep On <BEL> Character
(Enable)



*Do Not Beep On <BEL> Character
(Disable)



NOTE A NULL character must be sent to the imager before BEL to ensure the BEL character is processed correctly.

Intercharacter Delay

This parameter specifies the intercharacter delay inserted between character transmissions.



***Minimum: 0 msec**



Low: 25 msec

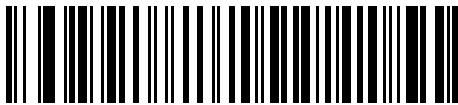

Medium: 50 msec



High: 75 msec

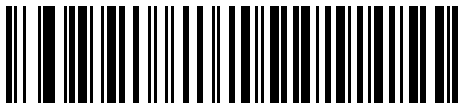

Maximum: 99 msec

Nixdorf Beep/LED Options

Select Nixdorf Mode B to indicate when the imager beeps and turns on its LED after a decode.

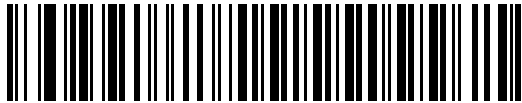

***Normal Operation**
(Beep/LED immediately after decode)



Beep/LED After Transmission

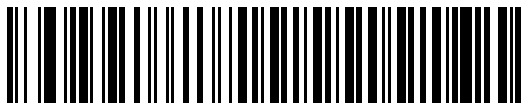

Beep/LED After CTS Pulse

Ignore Unknown Characters

Unknown characters are characters the host does not recognize. Select **Send Bar Codes with Unknown Characters** to send all bar code data except for unknown characters. The imager issues no error beeps. Select **Do Not Send Bar Codes With Unknown Characters** to send bar code data up to the first unknown character. The imager issues an error beep.

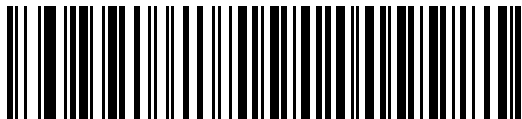

***Send Bar Code**
(with unknown characters)

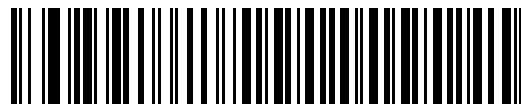

Do Not Send Bar Codes
(with unknown characters)

ASCII Character Set for Serial Hosts

You can assign the values in [Table 9-4](#) as prefixes or suffixes for ASCII character data transmission.

Table 9-4 *Prefix/Suffix Values*

Prefix/Suffix Value	Full ASCII Code 39 Encode Character	ASCII Character
1000	%U	NUL
1001	\$A	SOH
1002	\$B	STX
1003	\$C	ETX
1004	\$D	EOT
1005	\$E	ENQ
1006	\$F	ACK
1007	\$G	BELL
1008	\$H	BCKSPC
1009	\$I	HORIZ TAB
1010	\$J	LF/NW LN
1011	\$K	VT
1012	\$L	FF
1013	\$M	CR/ENTER
1014	\$N	SO
1015	\$O	SI
1016	\$P	DLE
1017	\$Q	DC1/XON
1018	\$R	DC2
1019	\$S	DC3/XOFF
1020	\$T	DC4
1021	\$U	NAK
1022	\$V	SYN
1023	\$W	ETB
1024	\$X	CAN
1025	\$Y	EM
1026	\$Z	SUB
1027	%A	ESC

Table 9-4 *Prefix/Suffix Values (Continued)*

Prefix/Suffix Value	Full ASCII Code 39 Encode Character	ASCII Character
1028	%B	FS
1029	%C	GS
1030	%D	RS
1031	%E	US
1032	Space	Space
1033	/A	!
1034	/B	"
1035	/C	#
1036	/D	\$
1037	/E	%
1038	/F	&
1039	/G	'
1040	/H	(
1041	/I)
1042	/J	*
1043	/K	+
1044	/L	,
1045	-	-
1046	.	.
1047	/O	/
1048	0	0
1049	1	1
1050	2	2
1051	3	3
1052	4	4
1053	5	5
1054	6	6
1055	7	7
1056	8	8
1057	9	9
1058	/Z	:

Table 9-4 *Prefix/Suffix Values (Continued)*

Prefix/Suffix Value	Full ASCII Code 39 Encode Character	ASCII Character
1059	%F	;
1060	%G	<
1061	%H	=
1062	%I	>
1063	%J	?
1064	%V	@
1065	A	A
1066	B	B
1067	C	C
1068	D	D
1069	E	E
1070	F	F
1071	G	G
1072	H	H
1073	I	I
1074	J	J
1075	K	K
1076	L	L
1077	M	M
1078	N	N
1079	O	O
1080	P	P
1081	Q	Q
1082	R	R
1083	S	S
1084	T	T
1085	U	U
1086	V	V
1087	W	W
1088	X	X
1089	Y	Y

Table 9-4 *Prefix/Suffix Values (Continued)*

Prefix/Suffix Value	Full ASCII Code 39 Encode Character	ASCII Character
1090	Z	Z
1091	%K	[
1092	%L	\
1093	%M]
1094	%N	^
1095	%O	_
1096	%W	`
1097	+A	a
1098	+B	b
1099	+C	c
1100	+D	d
1101	+E	e
1102	+F	f
1103	+G	g
1104	+H	h
1105	+I	i
1106	+J	j
1107	+K	k
1108	+L	l
1109	+M	m
1110	+N	n
1111	+O	o
1112	+P	p
1113	+Q	q
1114	+R	r
1115	+S	s
1116	+T	t
1117	+U	u
1118	+V	v
1119	+W	w
1120	+X	x

Table 9-4 *Prefix/Suffix Values (Continued)*

Prefix/Suffix Value	Full ASCII Code 39 Encode Character	ASCII Character
1121	+Y	y
1122	+Z	z
1123	%P	{
1124	%Q	
1125	%R	}
1126	%S	~
1127		Undefined
7013		ENTER

CHAPTER 10 USB INTERFACE

Introduction

This chapter describes how to set up the imager with a USB host. The imager connects directly to a USB host, or a powered USB hub, which powers it. No additional power supply is required.

Throughout the programming bar code menus, asterisks (*) indicate default values.

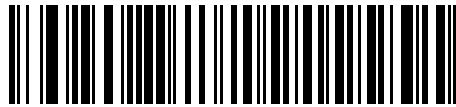

* Indicates Default — *North American Standard USB Keyboard — Feature/Option

- ✓ **NOTE** Most computer monitors allow scanning the bar codes directly on the screen. When scanning from the screen, be sure to set the document magnification to a level where you can see the bar code clearly, and bars and/or spaces are not merging.

USB Parameter Defaults

Table 10-1 lists the defaults for USB host parameters. To change any option, scan the appropriate bar code(s) provided in the Parameter Descriptions section beginning on [page 10-3](#).

✓ **NOTE** See [Appendix A, Standard Default Parameters](#) for all user preferences, hosts, symbologies, and miscellaneous default parameters.

Table 10-1 *USB Host Default Table*

Parameter	Default	Page Number
USB Host Parameters		
USB Device Type	USB HID Keyboard	10-3
Symbol Native API (SNAPI) Status Handshaking	Enable	10-5
USB Country Keyboard Types (Country Codes)	North American	10-6
USB Keystroke Delay	No Delay	10-8
USB CAPS Lock Override	Disable	10-8
USB Ignore Unknown Characters	Enable	10-9
Emulate Keypad	Disable	10-9
Emulate Keypad with Leading Zero	Disable	10-10
Quick Keypad Emulation	Disable	10-10
USB FN1 Substitution	Disable	10-11
Function Key Mapping	Disable	10-11
Simulated Caps Lock	Disable	10-12
Convert Case	None	10-13
USB Static CDC	Enable	10-13
USB Ignore Beep Directive	Honor	10-14
USB Ignore Type Directive	Honor	10-14
USB Polling Interval	3 msec	10-15
Fast HID Keyboard	Enable	10-17
IBM Specification Level	Version 0 (Original)	10-17

USB Host Parameters

USB Device Type

Select the desired USB device type.

- ✓ **NOTE** When changing USB Device Types, the imager automatically resets and issues the standard startup beep sequences.
- ✓ **NOTE** Before selecting **USB CDC Host**, install the CDC INF file on the host to ensure the imager does not stall during power up (due to a failure to enumerate USB). If the imager stalls, to recover it:
 - 1) Install the CDC INF file
 - or
 - 2) After power-up, hold the trigger for 10 seconds, which allows the imager to power up using an alternate USB configuration. Upon power-up, scan another **USB Device Type**.
- ✓ **NOTE** The **SSI over USB CDC** option enables a subset of the SSI protocol over the USB CDC interface which omits all hardware handshaking functionality. For more information refer to the *SSI Programmer's Guide*.
- ✓ **NOTE** Select **IBM Hand-Held USB** to disable data transmission when an IBM register issues a Scan Disable command. Aim, illumination, and decoding are still permitted. Select **OPOS (IBM Hand-held with Full Disable)** to completely shut off the imager when an IBM register issues a Scan Disable command, including aim, illumination, decoding, and data transmission.

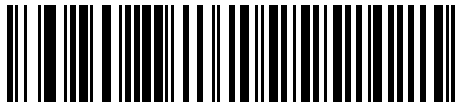

***USB HID Keyboard**



Symbol Native API (SNAPI) with Imaging Interface



Symbol Native API (SNAPI) without Imaging Interface

USB Device Type (continued)



USB CDC Host



Simple COM Port Emulation

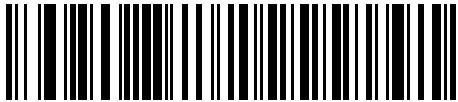

SSI over USB CDC

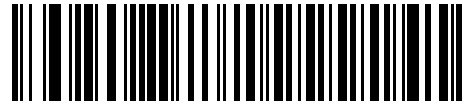

IBM Hand-Held USB



**OPOS
(IBM Hand-held with Full Disable)**

Symbol Native API (SNAPI) Status Handshaking

After selecting a SNAPI interface as the USB device type, select whether to enable or disable status handshaking.



***Enable SNAPI Status Handshaking**



Disable SNAPI Status Handshaking

USB Country Keyboard Types (Country Codes)

Scan the bar code corresponding to the keyboard type. This setting applies only to the USB Keyboard HID device.

✓ **NOTE** When changing USB country keyboard types the imager automatically resets. The imager issues the standard startup beep sequences.

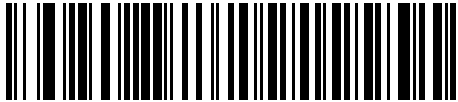

***North American Standard USB Keyboard**

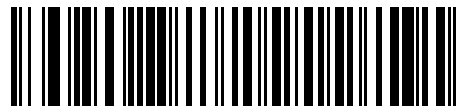

German Windows

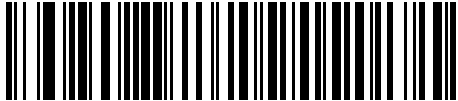

French Windows



French Canadian Windows 95/98



French Canadian Windows 2000/XP



French Belgian Windows

USB Country Keyboard Types (continued)



Spanish Windows



Italian Windows

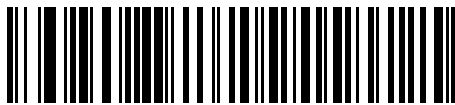

Swedish Windows



UK English Windows

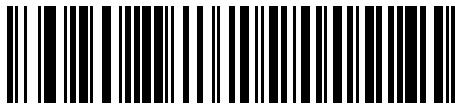

Japanese Windows (ASCII)



Portuguese-Brazilian Windows

USB Keystroke Delay

This parameter sets the delay, in milliseconds, between emulated keystrokes. Scan a bar code below to increase the delay when hosts require a slower data transmission.

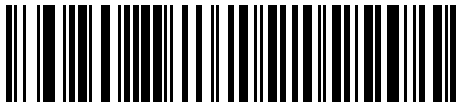

***No Delay**

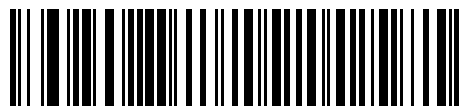

Medium Delay (20 msec)

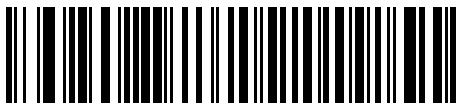

Long Delay (40 msec)

USB CAPS Lock Override

This option applies only to the USB Keyboard HID device. Enable this to preserve the case of the data regardless of the state of the caps lock key. This setting is always enabled for the Japanese, Windows (ASCII) keyboard type and can not be disabled.



**Override Caps Lock Key
(Enable)**

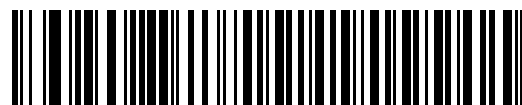

***Do Not Override Caps Lock Key
(Disable)**

USB Ignore Unknown Characters

This option applies only to the USB Keyboard HID device and IBM device. Unknown characters are characters the host does not recognize. Select **Send Bar Codes With Unknown Characters** to send all bar code data except for unknown characters. No error beeps sound. When **Do Not Send Bar Codes With Unknown Characters** is selected, for IBM devices, bar codes containing at least one unknown character are not sent to the host, and an error beep sounds. For USB Keyboard HID devices, the bar code characters up to the unknown character are sent, and an error beep sounds.

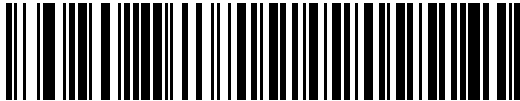

***Send Bar Codes with Unknown Characters
(Transmit)**



**Do Not Send Bar Codes with Unknown Characters
(Disable)**

Emulate Keypad

Enable this to send all characters as ASCII sequences over the numeric keypad. For example ASCII A is sent as "ALT make" 0 6 5 "ALT Break". This allows support for other country variants.



***Disable Keypad Emulation**



Enable Keypad Emulation

Emulate Keypad with Leading Zero

Enable this to send character sequences sent over the numeric keypad as ISO characters which have a leading zero. For example ASCII A is sent as “ALT MAKE” 0 0 6 5 “ALT BREAK”.



***Disable Keypad Emulation with Leading Zero**



Enable Keypad Emulation with Leading Zero

Quick Keypad Emulation

This option applies only to the USB Keyboard (HID) device and if *Emulate Keypad* is enabled. This parameter enables a quicker method of keypad emulation where ASCII sequences are only sent for ASCII characters not found on the keyboard. The default value is **Disable**.



Enable



***Disable**

USB Keyboard FN1 Substitution

This option applies only to the USB Keyboard HID device. Enable this to replace any FN1 characters in an EAN 128 bar code with a Key Category and value (see [FN1 Substitution Values on page 6-40](#) to set the Key Category and Key Value).



Enable FN1 Substitution



***Disable FN1 Substitution**

Function Key Mapping

ASCII values under 32 are normally sent as control-key sequences (see [Table 10-2 on page 10-18](#)). Enable this to send the keys in bold in place of the standard key mapping. Table entries that do not have a bold entry remain the same whether or not this parameter is enabled.

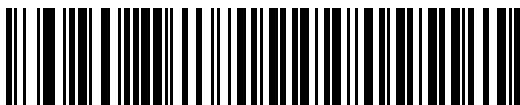

***Disable Function Key Mapping**

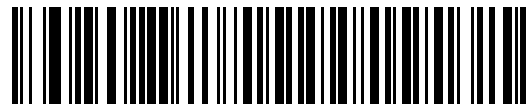

Enable Function Key Mapping

Simulated Caps Lock

Enable this to invert upper and lower case characters on the bar code as if the Caps Lock state is enabled on the keyboard. This inversion occurs regardless of the keyboard's current Caps Lock state.



***Disable Simulated Caps Lock**

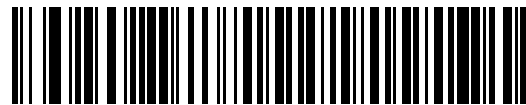

Enable Simulated Caps Lock

Convert Case

Enable this to convert all bar code data to the selected case.

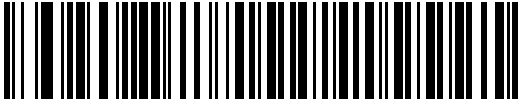

***No Case Conversion**

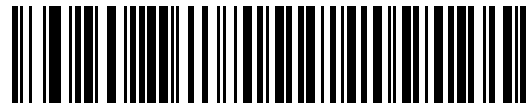

Convert All to Upper Case

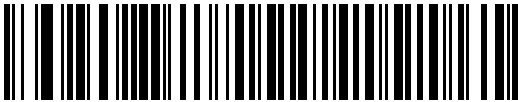

Convert All to Lower Case

USB Static CDC

When disabled, each device connected consumes another COM port (first device = COM1, second device = COM2, third device = COM3, etc.)

When enabled, each device connects to the same COM port.



***Enable USB Static CDC**



Disable USB Static CDC

USB Ignore Beep Directive

This applies only to IBM hand-held, IBM table-top, and OPOS devices. Scan one of the following bar codes to honor or ignore a beep directive. All directives are still acknowledged as if they were processed.



***Honor USB Beep Directive**



Ignore USB Beep Directive

USB Ignore Type Directive

This applies only to IBM hand-held, IBM table-top, and OPOS devices. Scan one of the following bar codes to honor or ignore a code type enable/disable directive. All directives are still acknowledged as if they were processed.

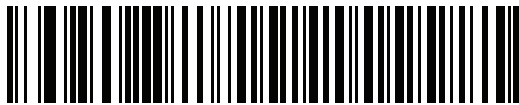

***Honor USB Ignore Type Directive**

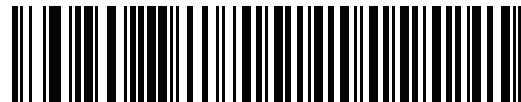

Ignore USB Ignore Type Directive

USB Polling Interval

This option speeds up the USB Keyboard HID Device. Scan one of the following bar codes to set the polling interval, which is the rate at which data can be sent between the image and the host computer. A lower number indicates a faster data rate. The default is 3 msec.

Changing the polling interval re-initializes the imager.



CAUTION Ensure the host can support the selected data rate. Selecting a data rate that is too fast for the host may result in lost data.



1 msec

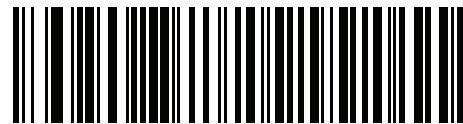

2 msec

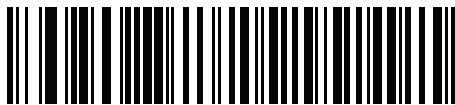

*3 msec



4 msec

USB Polling Interval (continued)



5 msec



6 msec



7 msec



8 msec

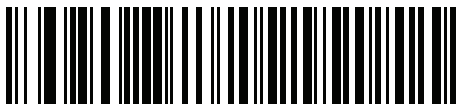

9 msec

Fast HID Keyboard

This option transmits USB Keyboard HID data at a faster rate.

✓ **NOTE** Quick Emulation overrides Fast HID.



*Enable



Disable

IBM Specification Level

When the IBM Specification Level is set to **Version 0 (Original)**, the following code types are sent as Unknown:

- Data Matrix
- QR Code
- MicroQR Code
- Aztec

When the level is set to **Version 2.2**, the code types are sent with the appropriate IBM identifiers.



*IBM Specification Level Version 0 (Original)



IBM Specification Level Version 2.2

ASCII Character Set for USB

Table 10-2 USB Prefix/Suffix Values

Prefix/ Suffix Value	Full ASCII Code 39 Encode Character	Keystroke
1000	%U	CTRL 2
1001	\$A	CTRL A
1002	\$B	CTRL B
1003	\$C	CTRL C
1004	\$D	CTRL D
1005	\$E	CTRL E
1006	\$F	CTRL F
1007	\$G	CTRL G
1008	\$H	CTRL H/ BACKSPACE ¹
1009	\$I	CTRL I/ HORIZONTAL TAB ¹
1010	\$J	CTRL J
1011	\$K	CTRL K
1012	\$L	CTRL L
1013	\$M	CTRL M/ ENTER ¹
1014	\$N	CTRL N
1015	\$O	CTRL O
1016	\$P	CTRL P
1017	\$Q	CTRL Q
1018	\$R	CTRL R
1019	\$S	CTRL S
1020	\$T	CTRL T
1021	\$U	CTRL U
1022	\$V	CTRL V
1023	\$W	CTRL W
1024	\$X	CTRL X
1025	\$Y	CTRL Y

¹The keystroke in bold is sent only if *Function Key Mapping* on page 10-11 is enabled. Otherwise, the unbolded keystroke is sent.

Table 10-2 USB Prefix/Suffix Values (Continued)

Prefix/ Suffix Value	Full ASCII Code 39 Encode Character	Keystroke
1026	\$Z	CTRL Z
1027	%A	CTRL [/ESC ¹
1028	%B	CTRL \
1029	%C	CTRL]
1030	%D	CTRL 6
1031	%E	CTRL -
1032	Space	Space
1033	/A	!
1034	/B	"
1035	/C	#
1036	/D	\$
1037	/E	%
1038	/F	&
1039	/G	'
1040	/H	(
1041	/I)
1042	/J	*
1043	/K	+
1044	/L	,
1045	-	-
1046	.	.
1047	/O	/
1048	0	0
1049	1	1
1050	2	2
1051	3	3
1052	4	4
1053	5	5
1054	6	6

¹The keystroke in bold is sent only if *Function Key Mapping* on page 10-11 is enabled. Otherwise, the unbolded keystroke is sent.

Table 10-2 USB Prefix/Suffix Values (Continued)

Prefix/ Suffix Value	Full ASCII Code 39 Encode Character	Keystroke
1055	7	7
1056	8	8
1057	9	9
1058	/Z	:
1059	%F	;
1060	%G	<
1061	%H	=
1062	%I	>
1063	%J	?
1064	%V	@
1065	A	A
1066	B	B
1067	C	C
1068	D	D
1069	E	E
1070	F	F
1071	G	G
1072	H	H
1073	I	I
1074	J	J
1075	K	K
1076	L	L
1077	M	M
1078	N	N
1079	O	O
1080	P	P
1081	Q	Q
1082	R	R
1083	S	S

¹The keystroke in bold is sent only if *Function Key Mapping on page 10-11* is enabled. Otherwise, the unbolded keystroke is sent.

Table 10-2 USB Prefix/Suffix Values (Continued)

Prefix/ Suffix Value	Full ASCII Code 39 Encode Character	Keystroke
1084	T	T
1085	U	U
1086	V	V
1087	W	W
1088	X	X
1089	Y	Y
1090	Z	Z
1091	%K	[
1092	%L	\
1093	%M]
1094	%N	^
1095	%O	_
1096	%W	`
1097	+A	a
1098	+B	b
1099	+C	c
1100	+D	d
1101	+E	e
1102	+F	f
1103	+G	g
1104	+H	h
1105	+I	i
1106	+J	j
1107	+K	k
1108	+L	l
1109	+M	m
1110	+N	n
1111	+O	o
1112	+P	p

¹The keystroke in bold is sent only if *Function Key Mapping on page 10-11* is enabled. Otherwise, the unbolded keystroke is sent.

Table 10-2 USB Prefix/Suffix Values (Continued)

Prefix/ Suffix Value	Full ASCII Code 39 Encode Character	Keystroke
1113	+Q	q
1114	+R	r
1115	+S	s
1116	+T	t
1117	+U	u
1118	+V	v
1119	+W	w
1120	+X	x
1121	+Y	y
1122	+Z	z
1123	%P	{
1124	%Q	
1125	%R	}
1126	%S	~

¹The keystroke in bold is sent only if *Function Key Mapping* on page 10-11 is enabled. Otherwise, the unbolded keystroke is sent.

Table 10-3 USB ALT Key Character Set

ALT Keys	Keystroke
2064	ALT 2
2065	ALT A
2066	ALT B
2067	ALT C
2068	ALT D
2069	ALT E
2070	ALT F
2071	ALT G
2072	ALT H
2073	ALT I
2074	ALT J
2075	ALT K
2076	ALT L

Table 10-3 *USB ALT Key Character Set (Continued)*

ALT Keys	Keystroke
2077	ALT M
2078	ALT N
2079	ALT O
2080	ALT P
2081	ALT Q
2082	ALT R
2083	ALT S
2084	ALT T
2085	ALT U
2086	ALT V
2087	ALT W
2088	ALT X
2089	ALT Y
2090	ALT Z

Table 10-4 *USB GUI Key Character Set*

GUI Key	Keystroke
3000	Right Control Key
3048	GUI 0
3049	GUI 1
3050	GUI 2
3051	GUI 3
3052	GUI 4
3053	GUI 5
3054	GUI 6
3055	GUI 7
3056	GUI 8
3057	GUI 9
3065	GUI A
3066	GUI B

Note: GUI Shift Keys - The Apple™ iMac keyboard has an apple key on either side of the space bar. Windows-based systems have a GUI key to the left of the left ALT key, and to the right of the right ALT key.

Table 10-4 *USB GUI Key Character Set (Continued)*

GUI Key	Keystroke
3067	GUI C
3068	GUI D
3069	GUI E
3070	GUI F
3071	GUI G
3072	GUI H
3073	GUI I
3074	GUI J
3075	GUI K
3076	GUI L
3077	GUI M
3078	GUI N
3079	GUI O
3080	GUI P
3081	GUI Q
3082	GUI R
3083	GUI S
3084	GUI T
3085	GUI U
3086	GUI V
3087	GUI W
3088	GUI X
3089	GUI Y
3090	GUI Z

Note: GUI Shift Keys - The Apple™ iMac keyboard has an apple key on either side of the space bar. Windows-based systems have a GUI key to the left of the left ALT key, and to the right of the right ALT key.

Table 10-5 *USB F Key Character Set*

F Keys	Keystroke
5001	F1
5002	F2
5003	F3

Table 10-5 *USB F Key Character Set (Continued)*

F Keys	Keystroke
5004	F4
5005	F5
5006	F6
5007	F7
5008	F8
5009	F9
5010	F10
5011	F11
5012	F12
5013	F13
5014	F14
5015	F15
5016	F16
5017	F17
5018	F18
5019	F19
5020	F20
5021	F21
5022	F22
5023	F23
5024	F24

Table 10-6 *USB Numeric Keypad Character Set*

Numeric Keypad	Keystroke
6042	*
6043	+
6044	undefined
6045	-
6046	.
6047	/
6048	0
6049	1

Table 10-6 *USB Numeric Keypad Character Set (Continued)*

Numeric Keypad	Keystroke
6050	2
6051	3
6052	4
6053	5
6054	6
6055	7
6056	8
6057	9
6058	Enter
6059	Num Lock

Table 10-7 *USB Extended Keypad Character Set*

Extended Keypad	Keystroke
7001	Break
7002	Delete
7003	PgUp
7004	End
7005	Pg Dn
7006	Pause
7007	Scroll Lock
7008	Backspace
7009	Tab
7010	Print Screen
7011	Insert
7012	Home
7013	Enter
7014	Escape
7015	Up Arrow
7016	Down Arrow
7017	Left Arrow
7018	Right Arrow

CHAPTER 11 OCR READING

Introduction

This chapter describes how to set up the imager for OCR reading. The DS457 can read 6 to 60 point OCR typeface. It supports font types OCR-A, OCR-B, MICR-E13B, and US Currency Serial Number.

OCR is not as secure as a bar code. To decrease OCR misdecodes and speed OCR reading, set an accurate OCR template and character subset, and use a check digit.

All OCR fonts are disabled by default. Enabling OCR can slow bar code decoding. Enabling more than one OCR font could also slow OCR decoding and impact OCR decoding accuracy.

Throughout the programming bar code menus, asterisks (*) indicate default values.



* Indicates Default — ***Disable OCR-A** — Feature/Option



NOTE Most computer monitors allow scanning the bar codes directly on the screen. When scanning from the screen, be sure to set the document magnification to a level where you can see the bar code clearly, and bars and/or spaces are not merging.

OCR Parameter Defaults

Table 11-1 lists the defaults for OCR parameters. To change any option, scan the appropriate bar code(s) provided in the Parameter Descriptions section beginning on [page 11-3](#).

✓ **NOTE** See [Appendix A, Standard Default Parameters](#) for all user preferences, hosts, symbologies, and miscellaneous default parameters.

Table 11-1 OCR Default Table

Parameter	Parameter Number	SSI Number	Default	Page Number
OCR Parameters				
OCR-A	680	F1h A8h	Disable	11-3
OCR-A Variant	684	F1h ACh	Full ASCII	11-3
OCR-B	681	F1h A9h	Disable	11-5
OCR-B Variant	685	F1h ADh	Full ASCII	11-6
MICR E13B	682	F1h AAh	Disable	11-9
US Currency	683	F1h ABh	Disable	11-10
OCR Orientation	687	F1h AFh	0°	11-10
OCR Lines	691	F1h B3h	1	11-12
OCR Minimum Characters	689	F1h B1h	3	11-13
OCR Maximum Characters	690	F1h B2h	100	11-13
OCR Security Level	554	F1h 2Ah	80	11-13
OCR Subset	686	F1h AEh	Selected font variant	11-14
OCR Quiet Zone	695	F1h B7h	50	11-14
OCR Bright Illumination	701	F1h BDh	Disable	11-15
OCR Template	547	F1h 23h	54R	11-16
OCR Check Digit Modulus	688	F1h B0h	1	11-25
OCR Check Digit Multiplier	700	F1h BCh	121212121212	11-26
OCR Check Digit Validation	694	F1h B6h	None	11-27
Inverse OCR	856	F2h 58h	None	11-31

OCR Parameters

Enable/Disable OCR-A

Parameter # 680 (SSI # F1h A8h)

To enable or disable OCR-A, scan one of the following bar codes.



Enable OCR-A
(1)

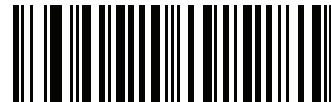

*Disable OCR-A
(0)

OCR-A Variant

Parameter # 684 (SSI # F1 ACh)

Font variant sets a processing algorithm and default character subset for the given font. To choose a variant, scan one of the following bar codes. Selecting the most appropriate font variant optimizes performance and accuracy.

OCR-A supports the following variants:

- OCR-A Full ASCII
!"#\$()*+,-./0123456789<>ABCDEFGHIJKLMNOPQRSTUVWXYZ^
- OCR-A Reserved 1
\$*+,-./0123456789ABCDEFGHIJKLMNOPQRSTUVWXYZ
- OCR-A Reserved 2
\$*+,-./0123456789<>ABCDEFGHIJKLMNOPQRSTUVWXYZ
- OCR-A Banking
-0123456789<> ƒ ɹ ʞ

Special banking characters output as the following representative characters:

ƒ outputs as f

ɹ outputs as c

ʞ outputs as h

✓ **NOTE** Enable OCR-A before setting this parameter. If disabling OCR-A, set the variant to its default (OCR-A Full ASCII).

OCR-A Variant (continued)



***OCR-A Full ASCII
(0)**



**OCR-A Reserved 1
(1)**



**OCR-A Reserved 2
(2)**



**OCR-A Banking
(3)**

Enable/Disable OCR-B

Parameter # 681 (SSI # F1h A9h)

To enable or disable OCR-B, scan one of the following bar codes.



**Enable OCR-B
(1)**



***Disable OCR-B
(0)**

OCR-B Variant

Parameter # 685 (SSI # F1 ADh)

OCR-B has the following variants. Selecting the most appropriate font variant affects performance and accuracy.

- OCR-B Full ASCII
!#\$%()*+,-./0123456789<>ABCDEFGHIJKLMNOPQRSTUVWXYZ^|ñ
- OCR-B Banking
#+-0123456789<>JNP|
- OCR-B Limited
+,-./0123456789<>ACENPSTVX
- OCR-B ISBN 10-Digit Book Numbers
-0123456789>BCEINPSXz
- OCR-B ISBN 10 or 13-Digit Book Numbers
-0123456789>BCEINPSXz
- OCR-B Travel Document Version 1 (TD1) 3-Line ID Cards
-0123456789<ABCDEFGHIJKLMNOPQRSTUVWXYZ
- OCR-B Travel Document Version 2 (TD2) 2-Line ID Cards
-0123456789<ABCDEFGHIJKLMNOPQRSTUVWXYZ
- OCR-B Travel Document 2 or 3-Line ID Cards Auto-Detect
!#\$%()*+,-./0123456789<>ABCDEFGHIJKLMNOPQRSTUVWXYZ^|ñ
- OCR-B Passport
-0123456789<ABCDEFGHIJKLMNOPQRSTUVWXYZñ
- OCR-B Visa Type A
-0123456789<ABCDEFGHIJKLMNOPQRSTUVWXYZ
- OCR-B Visa Type B
-0123456789<ABCDEFGHIJKLMNOPQRSTUVWXYZñ

To choose a variant, scan one of the following bar codes. Selecting the following OCR-B variants automatically sets the appropriate [OCR Lines on page 11-12](#). These five variants invoke extensive special algorithms and checking for that particular document type:

Variant	OCR Lines Setting
Passport	2
TD1 ID Cards	3
TD2 ID Cards	2
Visa Type A	2
Visa Type B	2

Selecting one of the ISBN Book Numbers automatically applies the appropriate ISBN checksum, so you do not need to set this.

OCR-B Variant (continued)

For the best performance in passport reading, fix the target passport and the imager in place (6.5 - 7.5”).

- ✓ **NOTE** Enable OCR-B before setting this parameter. If disabling OCR-B, set the variant to its default (OCR-B Full ASCII).



***OCR-B Full ASCII
(0)**

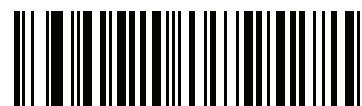

**OCR-B Banking
(1)**



**OCR-B Limited
(2)**

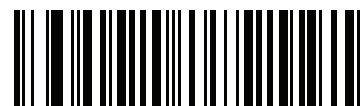

**OCR-B ISBN 10-Digit Book Numbers
(6)**



**OCR-B ISBN 10 or 13-Digit Book Numbers
(7)**



**OCR-B Travel Document Version 1 (TD1)
3 Line ID Cards
(3)**

OCR-B Variant (continued)



**OCR-B Travel Document Version 2 (TD2)
2-Line ID Cards
(8)**

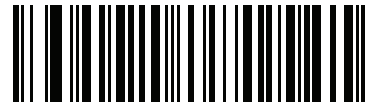

**Travel Document 2 or 3-Line ID Cards Auto-Detect
(14)**



**OCR-B Passport
(4)**



**OCR-B Visa Type A
(9)**



**OCR-B Visa Type B
(10)**

Enable/Disable MICR E13B

Parameter # 682 (SSI # F1h AAh)

To enable or disable MICR E13B, scan one of the following bar codes.

MICR E 13B uses the following characters:

0 1 2 3 4 5 6 7 8 9 : ; ' " #

TOAD characters (Transit, On Us, Amount, and Dash) output as the following representative characters:

: outputs as t

' outputs as a

" outputs as o

outputs as d



**Enable MICR E13B
(1)**



***Disable MICR E13B
(0)**

Enable/Disable US Currency Serial Number

Parameter # 683 (SSI # F1 ABh)

To enable or disable US Currency Serial Number, scan one of the following bar codes.



Enable US Currency
(1)



*Disable US Currency
(0)

OCR Orientation

Parameter # 687 (SSI # F1 AFh)

Select one of five options to specify the orientation of an OCR string to be read:

- 0° to the imaging engine (default)
- 270° clockwise (or 90° counterclockwise) to the imaging engine
- 180° (upside down) to the imaging engine
- 90° clockwise to the imaging engine
- Omnidirectional

Setting an incorrect orientation can cause misdecodes.

OCR Orientation (continued)



*OCR Orientation 0°
(0)



OCR Orientation 270° Clockwise
(1)



OCR Orientation 180° Clockwise
(2)



OCR Orientation 90° Clockwise
(3)



OCR Orientation Omnidirectional
(4)

OCR Lines

Parameter # 691 (SSI # F1 B3h)

To select the number of OCR lines to decode, scan one of the following bar codes. Selecting Visas, Passport, TD1, or TD2 ID cards automatically sets the appropriate **OCR Lines**. Also see [OCR-B Variant on page 11-6](#).



***OCR 1 Line
(1)**

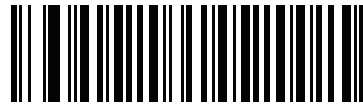

**OCR 2 Lines
(2)**



**OCR 3 Lines
(3)**

OCR Minimum Characters

Parameter # 689 (SSI # F1 B1h)

To select the minimum number of OCR characters (not including spaces) per line to decode, scan the following bar code, then scan a three-digit number between 003 and 100 using the Numeric Keypad from the *Advanced Data Formatting Programmer Guide* representing the number of OCR characters to decode. Strings of OCR characters less than the minimum are ignored. The default is 003.

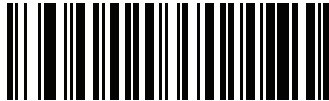

OCR Minimum Characters

OCR Maximum Characters

Parameter # 690 (SSI # F1 B2h)

To select the maximum number of OCR characters (including spaces) per line to decode, scan the following bar code, then scan a three-digit number between 003 and 100 using the Numeric Keypad from the *Advanced Data Formatting Programmer Guide* representing the number of OCR characters to decode. Strings of OCR characters greater than the maximum are ignored. The default is 100.



OCR Maximum Characters

OCR Security Level

Parameter # 554 (SSI # F1 2Ah)

To select the OCR decoding security/confidence level, scan the following bar code, then scan a two-digit number from the Numeric Keypad from the *Advanced Data Formatting Programmer Guide* representing the level of confidence. Greater numbers minimize OCR decoding errors but reduce performance. Setting a value that is too high can result in failure to decode. Setting a value that is too low can cause decoding errors. The range of the security level is 10 - 90 and the default is 80.



OCR Security Level

OCR Subset

Parameter # 686 (SSI # F1 AEh)

Set an OCR subset to define a custom group of characters in place of a preset font variant. For example, if scanning only numbers and the letters A, B, and C, create a subset of just these characters to speed decoding. This applies a designated OCR Subset across all enabled OCR fonts.

To set or modify the OCR font subset, first enable the appropriate OCR font(s). Next, scan the following bar code, then scan numbers and letters to form the OCR Subset from the Alphanumeric Keyboard from the *Advanced Data Formatting Programmer Guide*. Then scan End of Message from the *Advanced Data Formatting Programmer Guide*.



OCR Subset

To cancel an OCR subset, for OCR-A or OCR-B, scan OCR-A variant **Full ASCII**, or OCR-B variant **Full ASCII**.

For MICR E13B or US Currency Serial Number, create a subset which includes all allowed characters in that character set, or scan an option from the [Set Default Parameter on page 6-5](#) and re-program the imager.

OCR Quiet Zone

Parameter # 695 (SSI # F1h B7h)

This option sets the OCR quiet zone. The DS457 stops scanning a field when it detects a sufficiently wide blank space. The width of this space is defined by the End of Field option. Used with parsers that tolerate slanted characters, the End of Field count is roughly a count of 8 for a character width. For example if set to 15, then two character widths are an end of line indicator for the parser. Larger end of field numbers require bigger quiet zones at each end of text line.

To set a quiet zone, scan the following bar code, then scan a two-digit number using the Numeric Keypad from the *Advanced Data Formatting Programmer Guide*. The range of the quiet zone is 20 - 99 and the default is 50, indicating a six character width quiet zone.



OCR Quiet Zone

OCR Bright Illumination

Parameter # 701 (SSI # F1h BDh)

When enabled, image contrast is improved for OCR scanning. Zebra recommends enabling this when the OCR string is longer than 20 characters, and for applications with busy backgrounds such as passport, check, or VISA reading.

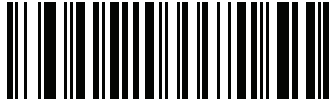

Enable OCR Bright Illumination
(1)



*Disable OCR Bright Illumination
(0)



NOTE Enabling **OCR Bright Illumination** causes the aiming pattern to blink due to the lower frame rate setting.

OCR Template

Parameter # 547 (SSI # F1 23h)

This option creates a template for precisely matching scanned OCR characters to a desired input format. Carefully constructing an OCR template eliminates scanning errors.

To set or modify the OCR decode template, scan the *OCR Template* bar code, then bar codes corresponding to numbers and letters on the following pages to form the template expression. Then scan *End of Message*. The default is **54R** which accepts any character OCR strings.



OCR Template



End of Message

Required Digit (9)



9

Only a numeric character is allowed in this position.

Template	Valid data	Valid data	Invalid data
99999	12987	30517	123AB

Required Alpha (A)



A

Only an alpha character is allowed in this position.

Template	Valid data	Valid data	Invalid data
AAA	ABC	WXY	12F

Require and Suppress (0)

It is required that any character in this position, including space or reject, is suppressed from the output.

Template	Incoming data	Output
990AA	12QAB	12AB

Optional Alphanumeric (1)**1**

When this option appears in the template string, the data validator accepts an alphanumeric character if present. Optional characters are not allowed as the first character(s) in a field of like characters.

Template	Valid data	Valid data	Invalid data
99991	1234A	12345	1234<

Optional Alpha (2)**2**

When this option appears in the template string, the data validator accepts an alpha character if present. Optional characters are not allowed as the first character(s) in a field of like characters.

Template	Valid data	Valid data	Invalid data
AAAA2	ABCDE	WXYZ	ABCD6

Alpha or Digit (3)**3**

The data validator requires an alphanumeric character in this position to validate the incoming data.

Template	Valid data	Valid data	Invalid data
33333	12ABC	WXYZ34	12AB<

Any Including Space & Reject (4)

4

The template accepts any character in this position, including space and reject. Rejects are represented as an underscore (_) in the output. This is a good selection for troubleshooting.

Template	Valid data	Valid data
99499	12\$34	34_98

Any except Space & Reject (5)

5

The template accepts any character in this position except a space or reject.

Template	Valid data	Valid data	Invalid data
55999	A.123	*Z456	A BCD

Optional Digit (7)

7

When this option appears in the template string, the template accepts a numeric character if present. Optional characters are not allowed as the first character(s) in a field of like characters.

Template	Valid data	Valid data	Invalid data
99977	12345	789	789AB

Digit or Fill (8)**8**

The data validator accepts any numeric or fill character in this position.

Template	Valid data	Valid data	Invalid data
88899	12345	>>789	<<789

Alpha or Fill (F)**F**

The data validator accepts any alpha or fill character in this position.

Template	Valid data	Valid data	Invalid data
AAAFF	ABCXY	LMN>>	ABC<5

Required Space ()**Space**

When this option appears in the template string, the template accepts a space if present. Optional characters are not allowed as the first character(s) in a field of like characters.

Template	Valid data	Invalid data
99 99	12 34	67891

Optional Small Special (.)



.

When this option appears in the template string, the data validator accepts a special character if present. Optional characters are not allowed as the first character(s) in a field of like characters. Small special characters are - , and .

Template	Valid data	Valid data	Invalid data
AA.99	MN.35	XY98	XYZ12

Other Template Operators

These template operators assist in capturing, delimiting, and formatting scanned OCR data.

Literal String (" and +)



"



+

Use either of these delimiting characters surrounding characters from the Alphanumeric Keyboard from the *Advanced Data Formatting Programmer Guide* to define a literal string within a template that must be present in scanned OCR data. There are two characters used to delimit required literal strings; if one of the delimiter characters is present in the desired literal string, use the other delimiter.

Template	Valid data	Invalid data
"35+BC"	35+BC	AB+22

New Line (E)**E**

To create a template of multiple lines, add **E** between the template of each single line.

Template	Valid data	Valid data	Invalid data
999EAAAA	321	987	XYZW
	BCAD	ZXYW	12

String Extract (C)**C**

This operator combined with others defines a string of characters to extract from the scanned data. The string extract is structured as follows:

CbPe

Where:

- **C** is the string extract operator
- **b** is the string begin delimiter
- **P** is a single template character representing all string characters to be extracted
- **e** is the string end delimiter

Values for **b** and **e** can be any scannable character. They are included in the output stream.

Template	Incoming data	Output
C>A>	XQ3>ABCDE>	>ABCDE>
	->ATHRUZ>123	>ATHRUZ>
	1ABCXYZ	No Output

Ignore to End of Field (D)**D**

This operator causes all characters after a template to be ignored. Use this as the last character in a template expression. Examples for the template 999D:

Template	Incoming data	Output
999D	123-PED	123
	357298	357
	193	193

Skip Until (P1)**P****1**

This operator allows skipping over characters until a specific character type or a literal string is detected. It can be used in two ways:

```
P1ct
```

Where:

- P1 is the Skip Until operator
- c is the type of character that triggers the start of output
- t is one or more template characters

```
P1"s"t
```

Where:

- P1 is the Skip Until operator
- "s" is one or more literal string characters (see [Literal String \(" and +\) on page 11-20](#)) that trigger the start of output
- t is one or more template characters

The trigger character or literal string is included in output from a Skip Until operator, and the first character in the template should accommodate this trigger.

Template	Incoming data	Output
P1"PN"AA9999	123PN9876	PN9876
	PN1234	PN1234
	X-PN3592	PN3592

Skip Until Not (P0)



P



0

This operator allows skipping over characters until a specific character type or a literal string is not matched in the output stream. It can be used in two ways:

P0ct

Where:

- P0 is the Skip Until Not operator
- c is the type of character that triggers the start of output
- t is one or more template characters

P0"s"t

Where:

- P0 is the Skip Until Not operator
- "s" is one or more literal string characters (see [Literal String \(" and +\) on page 11-20](#)) that trigger the start of output
- t is one or more template characters

The trigger character or literal string is not included in output from a Skip Until Not operator.

Template	Incoming data	Output
P0A9999	BN3456	3456
	PN1234	1234
	5341	5341

Template	Incoming data	Output
P0"PN"9999	PN3456	3456
	5341	5341
	PNPN7654	7654

Repeat Previous (R)



R

This operator allows a template character to repeat one or more times, allowing the capture of variable-length scanned data. The following examples capture two required alpha characters followed by one or more required digits:

Template	Incoming data	Output
AA9R	AB3	AB3
	PN12345	PN12345
	32RM52700	No output

Scroll Until Match (S)



S

This operator steps through scanned data one character at a time until the data matches the template.

Template	Incoming data	Output
S99999	AB3	No Output
	PN12345	12345
	32RM52700	52700

Multiple Templates

This feature sets up multiple templates for OCR decoding. To do this, follow the procedure described in [OCR Template on page 11-16](#) (scan the [OCR Template](#) bar code, then bar codes corresponding to numbers and letters to form the template expression, then **End of Message**) for each template in the multiple template string, using a capital letter **X** as a separator between the templates.

For example, set the [OCR Template](#) as **99999XAAAAA** to decode OCR strings of either **12345** or **ABCDE**.

Template Examples

Following are sample templates with descriptions of valid data for each definition.

Field Definition	Description
"M"99977	M followed by three digits and two optional digits.
"X"997777"X"	X followed by two digits, four optional digits, and an X .
9959775599	Two digits followed by any character, a digit, two optional digits, any two characters, and two digits.
A55"- "999"- "99	A letter followed by two characters, a dash, three digits, a dash, and two digits.
33A". "99	Two alphanumeric characters followed by a letter, a period, and two digits.
999992991	Five digits followed by an optional alpha, two digits, and an optional alphanumeric.
"PN98"	Literal field - PN98

OCR Check Digit Modulus

Parameter # 688 (SSI # F1h B0h)

This option sets OCR module check digit calculation. The check digit is the last digit (in the rightmost position) in an OCR string and improves the accuracy of the collected data. The check digit is the end product of a calculation made on the incoming data. For check digit calculation, for example Modulus 10, alpha and numeric characters are assigned numeric weights (see [OCR Check Digit Multiplier on page 11-26](#)). The calculation is applied to the character weights and the resulting check digit is added to the end of the data. If the incoming data does not match the check digit, the data is considered corrupt.

The selected check digit option does not take effect until you set **OCR Check Digit Validation**.

To choose the Check Digit Modulus, such as 10 for modulo 10, scan the following bar code, then scan a three-digit number from 001 to 099 representing the check digit using the Numeric Keypad from the *Advanced Data Formatting Programmer Guide*. The default is 1.



OCR Check Digit

OCR Check Digit Multiplier

Parameter # 700 (SSI # F1h BCh)

This option sets OCR check digit multipliers for the character positions. For check digit validation, each character in scanned data has an equivalent weight used in the check digit calculation. DS457 OCR ships with the following weight equivalents:

0 = 0	A = 10	K = 20	U = 30
1 = 1	B = 11	L = 21	V = 31
2 = 2	C = 12	M = 22	W = 32
3 = 3	D = 13	N = 23	X = 33
4 = 4	E = 14	O = 24	Y = 34
5 = 5	F = 15	P = 25	Z = 35
6 = 6	G = 16	Q = 26	Space = 0
7 = 7	H = 17	R = 27	
8 = 8	I = 18	S = 28	
9 = 9	J = 19	T = 29	

All other characters are equivalent to one (1).

You can define the multiplier string if it is different from the default.

121212121212 (default)

123456789A (for ISBN, Product Add Right to Left. See [OCR Check Digit Validation on page 11-27](#))

For example:

ISBN	0	2	0	1	1	8	3	9	9	4	
Multiplier	10	9	8	7	6	5	4	3	2	1	
Product	0	18	0	7	6	40	12	27	18	4	
Product add	0+	18+	0+	7+	6+	40+	12+	27+	18+	4=	132

ISBN uses modulo 11 for its check digit. In this case, 132 is divisible by 11, so it passes the check digit.

To set the check digit multiplier, scan the following bar code, then scan numbers and letters to form the multiplier string from the Alphanumeric Keyboard from the *Advanced Data Formatting Programmer Guide*. Then scan End of Message from the *Advanced Data Formatting Programmer Guide*.



OCR Check Digit Multiplier

OCR Check Digit Validation

Parameter # 694 (SSI # F1h B6h)

Use **OCR Check Digit Validation** to protect against scanning errors by applying a check digit validation scheme. The following is a list of options.

None

No check digit validation, indicating no check digit is applied. This is the default.



***No Check Digit
(0)**

Product Add Left to Right

Each character in the scanned data is assigned a numeric value (see [OCR Check Digit Multiplier on page 11-26](#)). Each digit representing a character in the scanned data is multiplied by its corresponding digit in the multiplier, and the sum of these products is computed. The check digit passes if this sum modulo Check Digit Modulus is zero.

Example:

Scanned data numeric value is 132456 (check digit is 6)

Check digit multiplier string is 123456

Digit	1	3	2	4	5	6
Multiplier	1	2	3	4	5	6
Product	1	6	6	16	25	36
Product add	1+	6+	6+	16+	25+	36= 90

The Check Digit Modulus is 10. It passes because 90 is divisible by 10 (the remainder is zero).



**Product Add Left to Right
(3)**

Product Add Right to Left

Each character in the scanned data is assigned a numeric value (see [OCR Check Digit Multiplier on page 11-26](#)). The check digit multiplier is reversed in order. Each value representing a character in the scanned data is multiplied by its corresponding digit in the reversed multiplier, resulting in a product for each character in the scanned data. The sum of these products is computed. The check digit passes if this sum modulo Check Digit Modulus is zero.

Example:

Scanned data numeric value is 132459 (check digit is 9)

Check digit multiplier string is 123456

Digit	1	3	2	4	5	9
Multiplier	6	5	4	3	2	1
Product	6	15	8	12	10	9
Product add	6+	15+	8+	12+	10+	9= 60

The Check Digit Modulus is 10. It passes because 60 is divisible by 10 (the remainder is 0).



Product Add Right to Left
(1)

Digit Add Left to Right

Each character in the scanned data is assigned a numeric value (see [OCR Check Digit Multiplier on page 11-26](#)). Each value representing a character in the scanned data is multiplied by its corresponding digit in the multiplier, resulting in a product for each character in the scanned data. The sum of each individual digit in all of the products is then calculated. The check digit passes if this sum modulo Check Digit Modulus is zero.

Example:

Scanned data numeric value is 132456 (check digit is 6)

Check digit multiplier string is 123456

Digit	1	3	2	4	5	6
Multiplier	1	2	3	4	5	6
Product	1	6	6	16	25	36
Digit add	1+	6+	6+	1+6+	2+5+	3+6= 36

The Check Digit Modulus is 12. It passes because 36 is divisible by 12 (the remainder is 0).

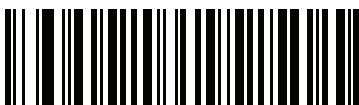

Digit Add Left to Right
(4)

Digit Add Right to Left

Each character in the scanned data is assigned a numeric value (see [OCR Check Digit Multiplier on page 11-26](#)). The check digit multiplier is reversed in order. Each value representing a character in the scanned data is multiplied by its corresponding digit in the reversed multiplier, resulting in a product for each character in the scanned data. The sum of each individual digit in all of the products is then calculated. The check digit passes if this sum modulo Check Digit Modulus is zero.

Example:

Scanned data numeric value is 132456 (check digit is 6)

Check digit multiplier string is 123456

Digit	1	3	2	4	5	6
Multiplier	6	5	4	3	2	1
Product	6	15	8	12	10	6
Digit add	6+	1+5+	8+	1+2+	1+0+	6= 30

The Check Digit Modulus is 10. It passes because 30 is divisible by 10 (the remainder is 0).



Digit Add Right to Left
(2)

Product Add Right to Left Simple Remainder

Each character in the scanned data is assigned a numeric value (see [OCR Check Digit Multiplier on page 11-26](#)). The check digit multiplier is reversed in order. Each value representing a character in the scanned data is multiplied by its corresponding digit in the reversed multiplier, resulting in a product for each character in the scanned data. The sum of these products **except for the check digit's product** is computed. The check digit passes if this sum modulo Check Digit Modulus is equal to the check digit's product.

Example:

Scanned data numeric value is 122456 (check digit is 6)

Check digit multiplier string is 123456

Digit	1	2	2	4	5	6
Multiplier	6	5	4	3	2	1
Product	6	10	8	12	10	6
Product add	6+	10+	8+	12+	10=	46 6

The Check Digit Modulus is 10. It passes because 46 divided by 10 leaves a remainder of 6.



Product Add Right to Left Simple Remainder
(5)

Digit Add Right To Left Simple Remainder

Each character in the scanned data is assigned a numeric value (see [OCR Check Digit Multiplier on page 11-26](#)). The check digit multiplier is reversed in order. Each value representing a character in the scanned data is multiplied by its corresponding digit in the reversed multiplier, resulting in a product for each character in the scanned data. The sum of each individual digit in all of the products **except for the check digit's product** is then calculated. The check digit passes if this sum modulo Check Digit Modulus is equal to the check digit's product.

Example:

Scanned data numeric value is 122459 (check digit is 6)

Check digit multiplier string is 123456

Digit	1	2	2	4	5	9
Multiplier	6	5	4	3	2	1
Product	6	10	8	12	10	9
Digit add	6+	1+0+	8+	1+2+	1+0=	19 9

The Check Digit Modulus is 10. It passes because 19 divided by 10 leaves a remainder of 9.

10



Digit Add Right to Left Simple Remainder
(6)

Health Industry - HIBCC43

This is the health industry module 43 check digit standard.



Health Industry - HIBCC43
(9)

Inverse OCR

Parameter # 856 (SSI # F2h 58h)

Inverse OCR is white or light words on a black or dark background. Select an option for decoding inverse OCR:

- **Regular Only** - decode regular OCR (black on white) strings only.
- **Inverse Only** - decode inverse OCR (white on black) strings only.
- **Autodiscriminate** - decodes both regular and inverse OCR strings.

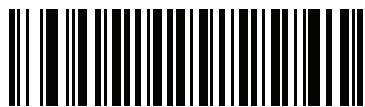

***Regular Only**
(0)



Inverse Only
(1)



Autodiscriminate
(2)

CHAPTER 12 SYMBOLOGIES

Introduction

This chapter describes symbology features and provides the programming bar codes for selecting these features. Before programming, follow the instructions in [Chapter 1, Getting Started](#).

The imager is shipped with the settings shown in the [Symbology Default Table on page 12-2](#) (also see [Appendix A, Standard Default Parameters](#) for all host device and miscellaneous defaults). If the default values suit requirements, programming is not necessary.

There are two ways to change a parameter value:

- Scan the appropriate bar codes in this guide. These new values replace the standard default values in memory.
- For SSI and USB SNAPI hosts, send a “parameter send” command from the host system. Hexadecimal parameter numbers are shown in this chapter below the parameter title, and options are shown in parenthesis beneath the accompanying bar codes. See the *Simple Serial Interface (SSI) Programmer’s Guide* for detailed instructions for changing parameter values using this method.

✓ **NOTE** Most computer monitors allow scanning the bar codes directly on the screen. When scanning from the screen, be sure to set the document magnification to a level where the bar code can be seen clearly, and bars and/or spaces are not merging.

To return all features to default values, scan [Set Default Parameter on page 6-5](#). Throughout the programming bar code menus, default values are indicated with asterisks (*).

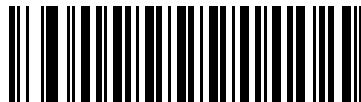

* Indicates Default — ***Enable UPC-A** — Feature'/Option
(0)

Scanning Sequence Examples

In most cases, scanning one bar code sets the parameter value. For example, to transmit bar code data without the UPC-A check digit, simply scan the **Do Not Transmit UPC-A Check Digit** bar code under [Transmit UPC-A Check Digit on page 12-17](#). The imager issues a fast warble beep and the LED turns green, signifying a successful parameter entry.

Other parameters, such as **Set Length(s) for D 2 of 5** require scanning several bar codes. See the individual parameter, such as **Set Length(s) for D 2 of 5**, for this procedure.

Errors While Scanning

Unless otherwise specified, to correct an error during a scanning sequence, just re-scan the correct parameter.

Symbology Parameter Defaults

[Table 12-1](#) lists the defaults for all symbologies parameters. To change any option, scan the appropriate bar code(s) provided in the Symbologies Parameters section beginning on [page 12-9](#).

✓ **NOTE** See [Appendix A, Standard Default Parameters](#) for all user preferences, hosts, and miscellaneous default parameters.

Table 12-1 Symbology Default Table

Parameter	Parameter Number	SSI Number	Default	Page Number
Disable All Symbologies	N/A	N/A	N/A	12-8
UPC/EAN				
UPC-A	1	01h	Enable	12-9
UPC-E	2	02h	Enable	12-9
UPC-E1	12	0Ch	Disable	12-10
EAN-8/JAN 8	4	04h	Enable	12-10
EAN-13/JAN 13	3	03h	Enable	12-11
Bookland EAN	83	53h	Disable	12-11
Decode UPC/EAN/JAN Supplementals (2 and 5 digits)	16	10h	Ignore	12-12
User-Programmable Supplementals				12-15
Supplemental 1:	579	F1h 43h		
Supplemental 2:	580	F1h 44h		
UPC/EAN/JAN Supplemental Redundancy	80	50h	10	12-15
UPC/EAN/JAN Supplemental AIM ID Format	672	F1h A0h	Combined	12-16

Table 12-1 Symbology Default Table (Continued)

Parameter	Parameter Number	SSI Number	Default	Page Number
Transmit UPC-A Check Digit	40	28h	Enable	12-17
Transmit UPC-E Check Digit	41	29h	Enable	12-17
Transmit UPC-E1 Check Digit	42	2Ah	Enable	12-18
UPC-A Preamble	34	22h	System Character	12-19
UPC-E Preamble	35	23h	System Character	12-20
UPC-E1 Preamble	36	24h	System Character	12-21
Convert UPC-E to A	37	25h	Disable	12-22
Convert UPC-E1 to A	38	26h	Disable	12-22
EAN-8/JAN-8 Extend	39	27h	Disable	12-23
Bookland ISBN Format	576	F1h 40h	ISBN-10	12-24
UCC Coupon Extended Code	85	55h	Disable	12-25
Coupon Report	730	F1h DAh	New Coupon Format	12-26
ISSN EAN	617	F1h 69h	Disable	12-27
Code 128				
Code 128	8	08h	Enable	12-28
Set Length(s) for Code 128	209, 210	D1h, D2h	Any Length	12-28
GS1-128 (formerly UCC/EAN-128)	14	0Eh	Enable	12-30
ISBT 128	84	54h	Enable	12-30
ISBT Concatenation	577	F1h 41h	Disable	12-31
Check ISBT Table	578	F1h 42h	Enable	12-32
ISBT Concatenation Redundancy	223	DFh	10	12-32
Code 128 Security Level	751	F3h EFh	Security Level 1	12-33
Code 39				
Code 39	0	00h	Enable	12-34
Trioptic Code 39	13	0Dh	Disable	12-34
Convert Code 39 to Code 32 (Italian Pharmacy Code)	86	56h	Disable	12-35
Code 32 Prefix	231	E7h	Disable	12-35
Set Length(s) for Code 39	18, 19	12h, 13h	2 to 55	12-36
Code 39 Check Digit Verification	48	30h	Disable	12-37

Table 12-1 Symbology Default Table (Continued)

Parameter	Parameter Number	SSI Number	Default	Page Number
Transmit Code 39 Check Digit	43	2Bh	Disable	12-48
Code 39 Full ASCII Conversion	17	11h	Disable	12-38
Buffer Code 39	113	71h	Disable	12-39
Code 39 Security Level	750	F3h EEh	Security Level 1	12-42
Code 93				
Code 93	9	09h	Disable	12-43
Set Length(s) for Code 93	26, 27	1Ah, 1Bh	4 to 55	12-43
Code 11				
Code 11	10	0Ah	Disable	12-45
Set Lengths for Code 11	28, 29	1Ch, 1Dh	4 to 55	12-45
Code 11 Check Digit Verification	52	34h	Disable	12-47
Transmit Code 11 Check Digit(s)	47	2Fh	Disable	12-48
Interleaved 2 of 5 (ITF)				
Interleaved 2 of 5 (ITF)	6	06h	Enable	12-48
Set Lengths for I 2 of 5	22, 23	16h, 17h	Range 6 - 55	12-49
I 2 of 5 Check Digit Verification	49	31h	Disable	12-50
Transmit I 2 of 5 Check Digit	44	2Ch	Disable	12-51
Convert I 2 of 5 to EAN 13	82	52h	Disable	12-51
I 2 of 5 Security Level	1121		Security Level 1	12-52
Discrete 2 of 5 (DTF)				
Discrete 2 of 5	5	05h	Disable	12-53
Set Length(s) for D 2 of 5	20, 21	14h 15h	12	12-53
Codabar (NW - 7)				
Codabar	7	07h	Disable	12-55
Set Lengths for Codabar	24, 25	18h, 19h	5 to 55	12-55
CLSI Editing	54	36h	Disable	12-57
NOTIS Editing	55	37h	Disable	12-57
Codabar Upper or Lower Case Start/Stop Characters Transmission	855	F2h 57h	Upper Case	12-58

Table 12-1 Symbology Default Table (Continued)

Parameter	Parameter Number	SSI Number	Default	Page Number
MSI				
MSI	11	0Bh	Disable	12-59
Set Length(s) for MSI	30, 31	1Eh, 1Fh	4 to 55	12-59
MSI Check Digits	50	32h	One	12-61
Transmit MSI Check Digit	46	2Eh	Disable	12-62
MSI Check Digit Algorithm	51	33h	Mod 10/Mod 10	12-62
Chinese 2 of 5				
Chinese 2 of 5	408	F0h 98h	Disable	12-63
Matrix 2 of 5				
Matrix 2 of 5	618	F1h 6Ah	Disable	12-63
Matrix 2 of 5 Lengths	619, 620	F1h 6Bh F1h 6Ch	1 Length: 14	12-64
Matrix 2 of 5 Check Digit	622	F1h 6Eh	Disable	12-65
Transmit Matrix 2 of 5 Check Digit	623	F1h 6Fh	Disable	12-65
Korean 3 of 5				
Korean 3 of 5	581	F1h 45h	Disable	12-66
Inverse 1D	586	F1h 4Ah	DS457-SR/HD/DL: Regular DS457-DP: Inverse Autodetect	12-67
Postal Codes				
US Postnet	89	59h	Disable	12-68
US Planet	90	5Ah	Disable	12-68
Transmit US Postal Check Digit	95	5Fh	Enable	12-69
UK Postal	91	5Bh	Disable	12-69
Transmit UK Postal Check Digit	96	60h	Enable	12-70
Japan Postal	290	F0h 22h	Disable	12-70
Australia Post	291	F0h 23h	Disable	12-71
Australia Post Format	718	F1h CEh	Autodiscriminate	12-72
Netherlands KIX Code	326	F0h 46h	Disable	12-73
USPS 4CB/One Code/Intelligent Mail	592	F1h 50h	Disable	12-74
UPU FICS Postal	611	F1h 63h	Disable	12-74

Table 12-1 Symbology Default Table (Continued)

Parameter	Parameter Number	SSI Number	Default	Page Number
GS1 DataBar (formerly RSS, Reduced Space Symbology)				
GS1 DataBar (GS1 DataBar Omnidirectional, GS1 DataBar Truncated, GS1 DataBar Stacked, GS1 DataBar Stacked Omnidirectional)	338	F0h 52h	Enable	12-75
GS1 DataBar Limited	339	F0h 53h	Enable	12-76
GS1 DataBar Limited Security Level	728	F1h D8h	3	12-77
GS1 DataBar Expanded (GS1 DataBar Expanded, GS1 DataBar Expanded Stacked)	340	F0h 54h	Enable	12-78
Convert GS1 DataBar to UPC/EAN	397	F0h 8Dh	Disable	12-78
Composite				
Composite CC-C	341	F0h 55h	Disable	12-79
Composite CC-A/B	342	F0h 56h	Disable	12-79
Composite TLC-39	371	F0h 73h	Disable	12-80
UPC Composite Mode	344	F0h 58h	Never Linked	12-81
Composite Beep Mode	398	F0h 8Eh	Beep As Each Code Type is Decoded	12-82
GS1-128 Emulation Mode for UCC/EAN Composite Codes	427	F0h ABh	Disable	12-82
2D Symbologies				
PDF417	15	0Fh	Enable	12-83
MicroPDF417	227	E3h	Disable	12-83
Code 128 Emulation	123	7Bh	Disable	12-84
Data Matrix	292	F0h 24h	Enable	12-85
Data Matrix Inverse	588	F1h 4Ch	DS457-SR/HD/DL: Regular DS457-DP: Inverse Autodetect	12-86
Decode Mirror Images (Data Matrix Only)	537	F1h 19h	Auto	12-87
Maxicode	294	F0h 26h	Disable	12-88
QR Code	293	F0h 25h	Enable	12-88
QR Inverse	587	F1h 4Bh	Regular	12-89
MicroQR	573	F1h 3Dh	Enable	12-90

Table 12-1 Symbology Default Table (Continued)

Parameter	Parameter Number	SSI Number	Default	Page Number
Aztec	574	F1h 3Eh	Enable	12-90
Aztec Inverse	589	F1h 4Dh	Inverse Autodetect	12-91
Symbology-Specific Security Levels				
Redundancy Level	78	4Eh	1	12-92
Security Level	77	4Dh	1	12-94
Intercharacter Gap Size	381	F0h 7Dh	Normal	12-95
Macro PDF				
Macro PDF Transmit/Decode Mode Symbols	188	BCh	Passthrough Mode	12-97
Transmit Macro PDF Control Header	184	B8h	Disable	12-98
Escape Characters	233	E9h	N/A	12-98
Flush Macro PDF Buffer	N/A	N/A	N/A	12-99
Abort Macro PDF Entry	N/A	N/A	N/A	12-99

Disable All Symbologies

Scan the bar code below to disable the decoding of all symbologies. Use this to simplify selecting a single symbology to decode by scanning this, then scanning the desired enable code type bar code. Note that the imager can still decode parameter bar codes.



Disable All Symbologies

UPC/EAN

Enable/Disable UPC-A

Parameter # 1 (SSI # 01h)

To enable or disable UPC-A, scan the appropriate bar code below.

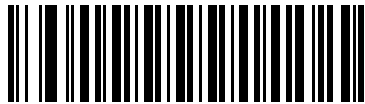

***Enable UPC-A
(1)**

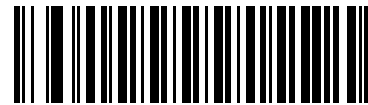

**Disable UPC-A
(0)**

Enable/Disable UPC-E

Parameter # 2 (SSI # 02h)

To enable or disable UPC-E, scan the appropriate bar code below.

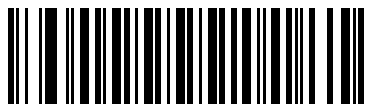

***Enable UPC-E
(1)**

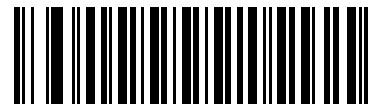

**Disable UPC-E
(0)**

Enable/Disable UPC-E1

Parameter # 12 (SSI # 0Ch)

UPC-E1 is disabled by default.

To enable or disable UPC-E1, scan the appropriate bar code below.

✓ **NOTE** UPC-E1 is not a UCC (Uniform Code Council) approved symbology.

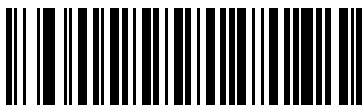

Enable UPC-E1
(1)



*Disable UPC-E1
(0)

Enable/Disable EAN-8/JAN-8

Parameter # 4 (SSI # 04h)

To enable or disable EAN-8/JAN-8, scan the appropriate bar code below.

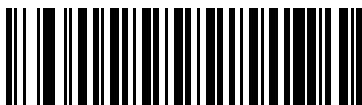

*Enable EAN-8/JAN-8
(1)



Disable EAN-8/JAN-8
(0)

Enable/Disable EAN-13/JAN-13

Parameter # 3 (SSI # 03h)

To enable or disable EAN-13/JAN-13, scan the appropriate bar code below.

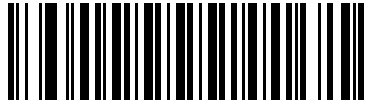

***Enable EAN-13/JAN-13
(1)**



**Disable EAN-13/JAN-13
(0)**

Enable/Disable Bookland EAN

Parameter # 83 (SSI # 53h)

To enable or disable Bookland EAN, scan the appropriate bar code below.

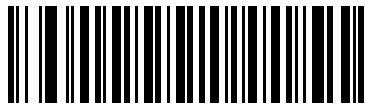

**Enable Bookland EAN
(1)**



***Disable Bookland EAN
(0)**



NOTE If you enable Bookland EAN, select a [Bookland ISBN Format on page 12-24](#). Also select either Decode UPC/EAN Supplementals, Autodiscriminate UPC/EAN Supplementals, or Enable 978/979 Supplemental Mode in [Decode UPC/EAN/JAN Supplementals on page 12-12](#).

Decode UPC/EAN/JAN Supplementals

Parameter # 16 (SSI # 10h)

Supplementals are bar codes appended according to specific format conventions (e.g., UPC A+2, UPC E+2, EAN 13+2). The following options are available:

- If you select **Ignore UPC/EAN with Supplementals**, and the imager is presented with a UPC/EAN plus supplemental symbol, the imager decodes UPC/EAN and ignores the supplemental characters.
- If you select **Decode UPC/EAN with Supplementals**, the imager only decodes UPC/EAN symbols with supplemental characters, and ignores symbols without supplementals.
- If you select **Autodiscriminate UPC/EAN Supplementals**, the imager decodes UPC/EAN symbols with supplemental characters immediately. If the symbol does not have a supplemental, the imager must decode the bar code the number of times set via [UPC/EAN/JAN Supplemental Redundancy on page 12-15](#) before transmitting its data to confirm that there is no supplemental.
- If you select one of the following **Supplemental Mode** options, the imager immediately transmits EAN-13 bar codes starting with that prefix that have supplemental characters. If the symbol does not have a supplemental, the imager must decode the bar code the number of times set via [UPC/EAN/JAN Supplemental Redundancy on page 12-15](#) before transmitting its data to confirm that there is no supplemental. The imager transmits UPC/EAN bar codes that do not have that prefix immediately.
 - Enable 378/379 Supplemental Mode
 - Enable 978/979 Supplemental Mode.

✓ **NOTE** If you select 978 Supplemental Mode and are scanning Bookland EAN bar codes, see [Enable/Disable Bookland EAN on page 12-11](#) to enable Bookland EAN, and select a format using [Bookland ISBN Format on page 12-24](#).

- Enable 977 Supplemental Mode
- Enable 414/419/434/439 Supplemental Mode
- Enable 491 Supplemental Mode
- **Enable Smart Supplemental Mode** - applies to EAN-13 bar codes starting with any prefix listed previously.
- **Supplemental User-Programmable Type 1** - applies to EAN-13 bar codes starting with a 3-digit user-defined prefix. Set this 3-digit prefix using [User-Programmable Supplementals on page 12-15](#).
- **Supplemental User-Programmable Type 1 and 2** - applies to EAN-13 bar codes starting with either of two 3-digit user-defined prefixes. Set the 3-digit prefixes using [User-Programmable Supplementals on page 12-15](#).
- **Smart Supplemental Plus User-Programmable 1** - applies to EAN-13 bar codes starting with any prefix listed previously or the user-defined prefix set using [User-Programmable Supplementals on page 12-15](#).
- **Smart Supplemental Plus User-Programmable 1 and 2** - applies to EAN-13 bar codes starting with any prefix listed previously or one of the two user-defined prefixes set using [User-Programmable Supplementals on page 12-15](#).

✓ **NOTE** To minimize the risk of invalid data transmission, select either to decode or ignore supplemental characters.

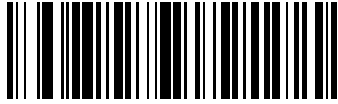
Decode UPC/EAN/JAN Supplementals (continued)

**Decode UPC/EAN/JAN Only With Supplementals
(1)**



***Ignore Supplementals
(0)**

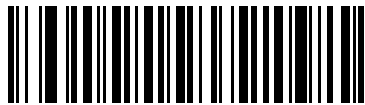

**Autodiscriminate UPC/EAN/JAN Supplementals
(2)**



**Enable 378/379 Supplemental Mode
(4)**



**Enable 978/979 Supplemental Mode
(5)**



**Enable 977 Supplemental Mode
(7)**

Decode UPC/EAN/JAN Supplementals (continued)



Enable 414/419/434/439 Supplemental Mode
(6)



Enable 491 Supplemental Mode
(8)



Enable Smart Supplemental Mode
(3)



Supplemental User-Programmable Type 1
(9)



Supplemental User-Programmable Type 1 and 2
(10)



Smart Supplemental Plus User-Programmable 1
(11)



Smart Supplemental Plus User-Programmable 1 and 2
(12)

User-Programmable Supplementals

Supplemental 1: Parameter # 579 (SSI # F1h 43h)

Supplemental 2: Parameter # 580 (SSI # F1h 44h)

If you selected a Supplemental User-Programmable option from [Decode UPC/EAN/JAN Supplementals on page 12-12](#), select **User-Programmable Supplemental 1** to set the 3-digit prefix. Then select the 3 digits using the numeric bar codes in [Appendix D, Numeric Bar Codes](#). Select **User-Programmable Supplemental 2** to set a second 3-digit prefix. Then select the 3 digits using the numeric bar codes beginning in [Appendix D, Numeric Bar Codes](#).



User-Programmable Supplemental 1



User-Programmable Supplemental 2

UPC/EAN/JAN Supplemental Redundancy

Parameter # 80 (SSI # 50h)

With **Autodiscriminate UPC/EAN/JAN Supplementals** selected, this option adjusts the number of times a symbol without supplementals is decoded before transmission. The range is from two to thirty times. Five or above is recommended when decoding a mix of UPC/EAN/JAN symbols with and without supplementals, and the autodiscriminate option is selected. The default is set at 10.

Scan the bar code below to set a decode redundancy value. Next, scan two numeric bar codes in [Appendix D, Numeric Bar Codes](#). Single digit numbers must have a leading zero. To correct an error or change a selection, scan **Cancel** on [page D-3](#).



UPC/EAN/JAN Supplemental Redundancy

UPC/EAN/JAN Supplemental AIM ID Format

Parameter # 672 (SSI # F1h A0h)

Select an output format when reporting UPC/EAN/JAN bar codes with Supplementals with *Transmit Code ID Character on page 6-37* set to **AIM Code ID Character**:

- **Separate** - transmit UPC/EAN with supplementals with separate AIM IDs but one transmission, i.e.:
]E<0 or 4><data>]E<1 or 2>[supplemental data]
- **Combined** – transmit UPC/EAN with supplementals with one AIM ID and one transmission, i.e.:
]E3<data+supplemental data>
- **Separate Transmissions** - transmit UPC/EAN with supplementals with separate AIM IDs and separate transmissions, i.e.:
]E<0 or 4><data>
]E<1 or 2>[supplemental data]

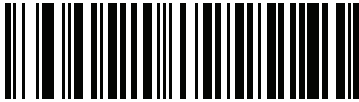

Separate
(0)



***Combined**
(1)



Separate Transmissions
(2)

Transmit UPC-A Check Digit

Parameter # 40 (SSI # 28h)

The check digit is the last character of the symbol used to verify the integrity of the data. Scan the appropriate bar code below to transmit the bar code data with or without the UPC-A check digit. It is always verified to guarantee the integrity of the data.

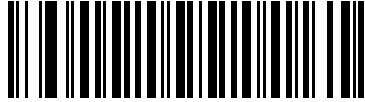

***Transmit UPC-A Check Digit
(1)**

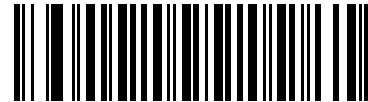

**Do Not Transmit UPC-A Check Digit
(0)**

Transmit UPC-E Check Digit

Parameter # 41 (SSI # 29h)

The check digit is the last character of the symbol used to verify the integrity of the data. Scan the appropriate bar code below to transmit the bar code data with or without the UPC-E check digit. It is always verified to guarantee the integrity of the data.

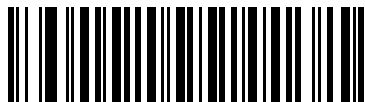

***Transmit UPC-E Check Digit
(1)**

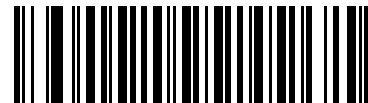

**Do Not Transmit UPC-E Check Digit
(0)**

Transmit UPC-E1 Check Digit

Parameter # 42 (SSI # 2Ah)

The check digit is the last character of the symbol used to verify the integrity of the data. Scan the appropriate bar code below to transmit the bar code data with or without the UPC-E1 check digit. It is always verified to guarantee the integrity of the data.

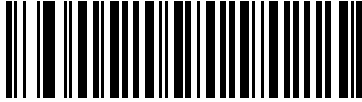

***Transmit UPC-E1 Check Digit
(1)**

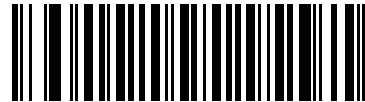

**Do Not Transmit UPC-E1 Check Digit
(0)**

UPC-A Preamble

Parameter # 34 (SSI # 22h)

Preamble characters are part of the UPC symbol, and include Country Code and System Character. There are three options for transmitting a UPC-A preamble to the host device: transmit System Character only, transmit System Character and Country Code ("0" for USA), and transmit no preamble. Select the appropriate option to match the host system.

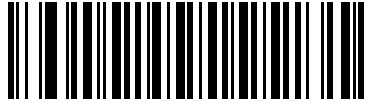

No Preamble (<DATA>)
(0)

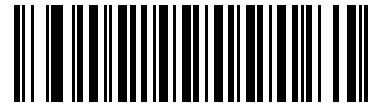

***System Character**
(<SYSTEM CHARACTER> <DATA>)
(1)

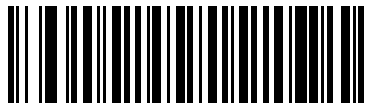

System Character & Country Code
(< COUNTRY CODE> <SYSTEM CHARACTER>
<DATA>)
(2)

UPC-E Preamble

Parameter # 35 (SSI # 23h)

Preamble characters are part of the UPC symbol, and include Country Code and System Character. There are three options for transmitting a UPC-E preamble to the host device: transmit System Character only, transmit System Character and Country Code ("0" for USA), and transmit no preamble. Select the appropriate option to match the host system.

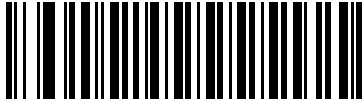

No Preamble (<DATA>)
(0)



***System Character**
(<SYSTEM CHARACTER> <DATA>)
(1)

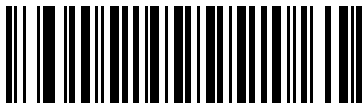

System Character & Country Code
(< COUNTRY CODE> <SYSTEM CHARACTER>
<DATA>)
(2)

UPC-E1 Preamble

Parameter # 36 (SSI # 24h)

Preamble characters are part of the UPC symbol, and include Country Code and System Character. There are three options for transmitting a UPC-E1 preamble to the host device: transmit System Character only, transmit System Character and Country Code ("0" for USA), and transmit no preamble. Select the appropriate option to match the host system.

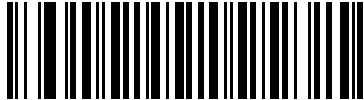

No Preamble (<DATA>)
(0)



*System Character
(<SYSTEM CHARACTER> <DATA>)
(1)

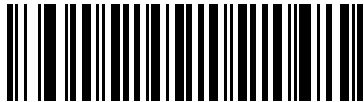

System Character & Country Code
(<COUNTRY CODE> <SYSTEM CHARACTER>
<DATA>)
(2)

Convert UPC-E to UPC-A

Parameter # 37 (SSI # 25h)

Enable this to convert UPC-E (zero suppressed) decoded data to UPC-A format before transmission. After conversion, the data follows UPC-A format and is affected by UPC-A programming selections (e.g., Preamble, Check Digit).

When disabled, UPC-E decoded data is transmitted as UPC-E data, without conversion.

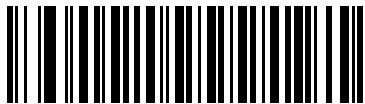

Convert UPC-E to UPC-A (Enable)
(1)

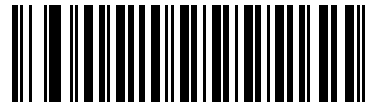

***Do Not Convert UPC-E to UPC-A (Disable)**
(0)

Convert UPC-E1 to UPC-A

Parameter # 38 (SSI # 26h)

Enable this to convert UPC-E1 decoded data to UPC-A format before transmission. After conversion, the data follows UPC-A format and is affected by UPC-A programming selections (e.g., Preamble, Check Digit).

When disabled, UPC-E1 decoded data is transmitted as UPC-E1 data, without conversion.

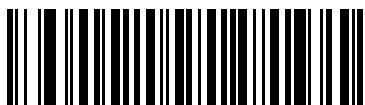

Convert UPC-E1 to UPC-A (Enable)
(1)

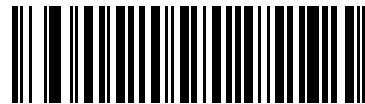

***Do Not Convert UPC-E1 to UPC-A (Disable)**
(0)

EAN-8/JAN-8 Extend

Parameter # 39 (SSI # 27h)

When enabled, this parameter adds five leading zeros to decoded EAN-8 symbols to make them compatible in format to EAN-13 symbols.

When disabled, EAN-8 symbols are transmitted as is.

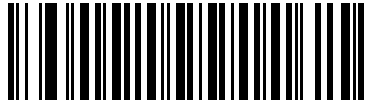

**Enable EAN/JAN Zero Extend
(1)**

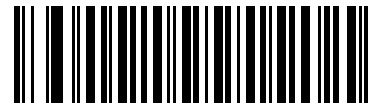

***Disable EAN/JAN Zero Extend
(0)**

Bookland ISBN Format

Parameter # 576 (SSI # F1h 40h)

If you enabled Bookland EAN using [Enable/Disable Bookland EAN on page 12-11](#), select one of the following formats for Bookland data:

- **Bookland ISBN-10** - The imager reports Bookland data starting with 978 in traditional 10-digit format with the special Bookland check digit for backward-compatibility. Data starting with 979 is not considered Bookland in this mode.
- **Bookland ISBN-13** - The imager reports Bookland data (starting with either 978 or 979) as EAN-13 in 13-digit format to meet the 2007 ISBN-13 protocol.



***Bookland ISBN-10**
(0)



Bookland ISBN-13
(1)



NOTE For Bookland EAN to function properly, first enable Bookland EAN using [Enable/Disable Bookland EAN on page 12-11](#), then select either Decode UPC/EAN Supplementals, Autodiscriminate UPC/EAN Supplementals, or Enable 978/979 Supplemental Mode in [Decode UPC/EAN/JAN Supplementals on page 12-12](#).

UCC Coupon Extended Code

Parameter # 85 (SSI # 55h)

When enabled, this parameter decodes UPC-A bar codes starting with digit '5', EAN-13 bar codes starting with digit '99', and UPC-A/EAN-128 Coupon Codes. UPCA, EAN-13, and EAN-128 must be enabled to scan all types of Coupon Codes.



Enable UCC Coupon Extended Code
(1)



*Disable UCC Coupon Extended Code
(0)



NOTE Use the Decode UPC/EAN Supplemental Redundancy parameter to control autodiscrimination of the EAN128 (right half) of a coupon code.

Coupon Report

Parameter # 730 (SSI # F1h DAh)

Traditional coupon symbols (old coupon symbols) are composed of two bar codes: UPC/EAN and Code128. A new coupon symbol is composed of a single Databar Expanded bar code. The new coupon format offers more options for purchase values (up to \$999.99) and supports complex discount offers such as a second purchase requirement.

An interim coupon symbol also exists that contains both types of bar codes: UPC/EAN and Databar Expanded. This format accommodates both retailers that do not recognize or use the additional information included in the new coupon symbol, as well as those who can process new coupon symbols.

Scan a bar code below to select one of the following options for decoding coupon symbols:

- **Old Coupon Format** - Scanning an old coupon symbol reports both the UPC and Code 128 portion of the symbol if both are present in the field of view. The imager may report either the UPC or the Code 128 if only one is within the field of view or is readable. [UPC/EAN/JAN Supplemental Redundancy on page 12-15](#) controls the number of times the imager attempts to decode the entire symbol before transmission. Additionally, scanning an interim coupon symbol reports UPC, and scanning a new coupon symbol reports nothing (no decode).
- **New Coupon Format** - Scanning an old coupon symbol reports either UPC or Code 128, and scanning an interim coupon symbol or a new coupon symbol reports Databar Expanded.
- **Both Coupon Formats** - Scanning an old coupon symbol reports both the UPC and Code 128 portion of the symbol if both are present in the field of view. The imager may report either the UPC or the Code 128 if only one is within the field of view or is readable. [UPC/EAN/JAN Supplemental Redundancy on page 12-15](#) controls the number of times the imager attempts to decode the entire symbol before transmission. Additionally, scanning an interim coupon symbol or a new coupon symbol reports Databar Expanded.



Old Coupon Format
(0)



***New Coupon Format**
(1)



Both Coupon Formats
(2)

ISSN EAN**Parameter # 617 (SSI # F1h 69h)**

To enable or disable ISSN EAN, scan the appropriate bar code below.



Enable ISSN EAN
(1)

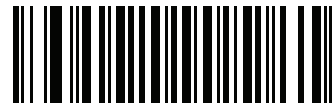

***Disable ISSN EAN**
(0)

Code 128

Enable/Disable Code 128

Parameter # 8 (SSI # 08h)

To enable or disable Code 128, scan the appropriate bar code below.

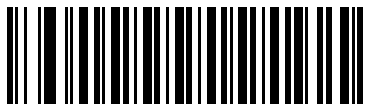

*Enable Code 128
(1)

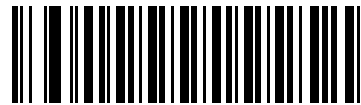

Disable Code 128
(0)

Set Lengths for Code 128

Parameter # L1 = 209 (SSI # D1h), L2 = 210 (SSI # D2h)

The length of a code refers to the number of characters (i.e., human readable characters), including check digit(s) the code contains. Set lengths for Code 128 to any length, one or two discrete lengths, or lengths within a specific range.



NOTE When setting lengths for different bar code types by scanning single digit numbers, single digit numbers must always be preceded by a leading zero.

- **One Discrete Length** - Select this option to decode only Code 128 symbols containing a selected length. Select the length using the numeric bar codes in [Appendix D, Numeric Bar Codes](#). For example, to decode only Code 128 symbols with 14 characters, scan **Code 128 - One Discrete Length**, then scan **1** followed by **4**. To correct an error or change the selection, scan [Cancel on page D-3](#).
- **Two Discrete Lengths** - Select this option to decode only Code 128 symbols containing either of two selected lengths. Select lengths using the numeric bar codes in [Appendix D, Numeric Bar Codes](#). For example, to decode only those Code 128 symbols containing either 2 or 14 characters, select **Code 128 - Two Discrete Lengths**, then scan **0, 2, 1**, and then **4**. To correct an error or change the selection, scan [Cancel on page D-3](#).
- **Length Within Range** - Select this option to decode a Code 128 symbol with a specific length range. Select lengths using numeric bar codes in [Appendix D, Numeric Bar Codes](#). For example, to decode Code 128 symbols containing between 4 and 12 characters, first scan **Code 128 - Length Within Range**. Then scan **0, 4, 1**, and **2** (single digit numbers must always be preceded by a leading zero). To correct an error or change the selection, scan [Cancel on page D-3](#).
- **Any Length** - Select this option to decode Code 128 symbols containing any number of characters within the imager's capability.

Set Lengths for Code 128 (continued)

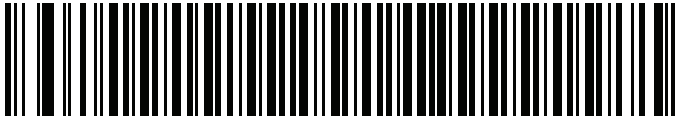

Code 128 - One Discrete Length

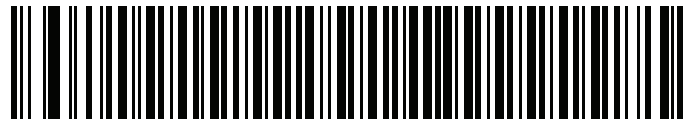

Code 128 - Two Discrete Lengths

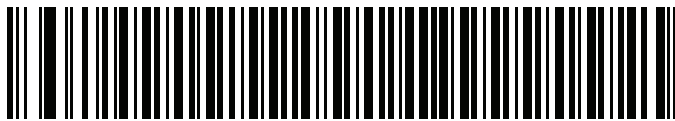

Code 128 - Length Within Range

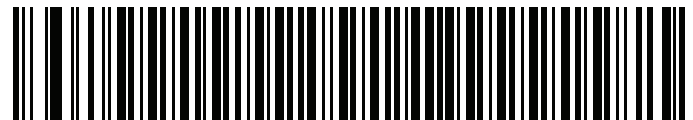

*Code 128 - Any Length

Enable/Disable GS1-128 (formerly UCC/EAN-128)

Parameter # 14 (SSI # 0Eh)

To enable or disable GS1-128, scan the appropriate bar code below.

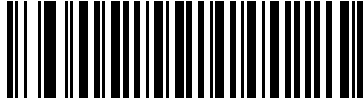

***Enable GS1-128**
(1)

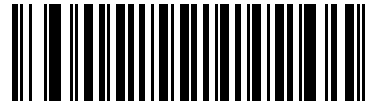

Disable GS1-128
(0)

Enable/Disable ISBT 128

Parameter # 84 (SSI # 54h)

ISBT 128 is a variant of Code 128 used in the blood bank industry. Scan a bar code below to enable or disable ISBT 128. If necessary, the host must perform concatenation of the ISBT data.



***Enable ISBT 128**
(1)



Disable ISBT 128
(0)

ISBT Concatenation

Parameter # 577 (SSI # F1h 41h)

Select an option for concatenating pairs of ISBT code types:

- If you select **Disable ISBT Concatenation**, the imager does not concatenate pairs of ISBT codes it encounters.
- If you select **Enable ISBT Concatenation**, there must be two ISBT codes in order for the imager to decode and perform concatenation. The imager does not decode single ISBT symbols.
- If you select **Autodiscriminate ISBT Concatenation**, the imager decodes and concatenates pairs of ISBT codes immediately. If only a single ISBT symbol is present, the imager must decode the symbol the number of times set via [ISBT Concatenation Redundancy on page 12-32](#) before transmitting its data to confirm that there is no additional ISBT symbol.



***Disable ISBT Concatenation
(0)**



**Enable ISBT Concatenation
(1)**



**Autodiscriminate ISBT Concatenation
(2)**

Check ISBT Table

Parameter # 578 (SSI # F1h 42h)

The ISBT specification includes a table that lists several types of ISBT bar codes that are commonly used in pairs. If you set **ISBT Concatenation** to **Enable**, enable **Check ISBT Table** to concatenate only those pairs found in this table. Other types of ISBT codes are not concatenated.

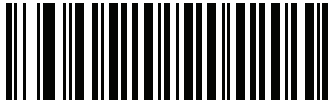

*Enable Check ISBT Table
(1)

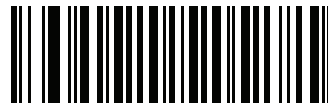

Disable Check ISBT Table
(0)

ISBT Concatenation Redundancy

Parameter # 223 (SSI # DFh)

If you set **ISBT Concatenation** to **Autodiscriminate**, use this parameter to set the number of times the imager must decode an ISBT symbol before determining that there is no additional symbol.

Scan the bar code below, then scan two numeric bar codes in [Appendix D, Numeric Bar Codes](#) to set a value between 2 and 20. Enter a leading zero for single digit numbers. To correct an error or change a selection, scan [Cancel on page D-3](#). The default is 10.



ISBT Concatenation Redundancy

Code 128 Security Level

Parameter # 751 (SSI # F3h EFh)

Code 128 bar codes are vulnerable to misdecodes by the nature of the symbol, especially when **Any Length** is set for Code 128 bar codes. The imager offers four levels of decode security for Code 128 bar codes. There is an inverse relationship between security and imager aggressiveness. Increasing the level of security may result in reduced aggressiveness in scanning, so select only the level of security necessary.

- **Code 128 Security Level 0:** This setting allows the imager to operate in its most aggressive state, while providing sufficient security in decoding the most in-spec bar codes.
- **Code 128 Security Level 1:** A bar code must be successfully read twice, and satisfy certain safety requirements before being decoded. This default setting eliminates most misdecodes.
- **Code 128 Security Level 2:** Select this option with higher safety requirements to the bar codes if **Security Level 1** fails to eliminate misdecodes.
- **Code 128 Security Level 3:** If you selected **Security Level 2**, and misdecodes still occur, select this security level. The highest safety requirements are applied. A bar code must be successfully read three times before being decoded.

✓ **NOTE** Selecting this option is an extreme measure against mis-decoding severely out-of-spec bar codes. Selecting this level of security significantly impairs the decoding ability of the imager. If this level of security is required, it is recommended that you try to improve the quality of the bar codes.

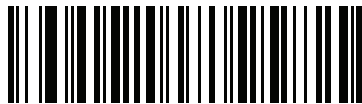

Code 128 Security Level 0
(0)



*Code 128 Security Level 1
(1)



Code 128 Security Level 2
(2)



Code 128 Security Level 3
(3)

Code 39

Enable/Disable Code 39

Parameter # 0 (SSI # 00h)

To enable or disable Code 39, scan the appropriate bar code below.

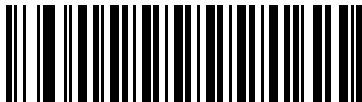

***Enable Code 39**
(1)



Disable Code 39
(0)

Enable/Disable Trioptic Code 39

Parameter # 13 (SSI # 0Dh)

Trioptic Code 39 is a variant of Code 39 used in the marking of computer tape cartridges. Trioptic Code 39 symbols always contain six characters. To enable or disable Trioptic Code 39, scan the appropriate bar code below.

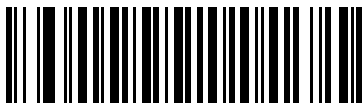

Enable Trioptic Code 39
(1)



***Disable Trioptic Code 39**
(0)



NOTE Trioptic Code 39 and Code 39 Full ASCII cannot be enabled simultaneously.

Convert Code 39 to Code 32

Parameter # 86 (SSI # 56h)

Code 32 is a variant of Code 39 used by the Italian pharmaceutical industry. Scan the appropriate bar code below to enable or disable converting Code 39 to Code 32.

✓ **NOTE** Code 39 must be enabled for this parameter to function.

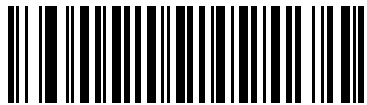

Enable Convert Code 39 to Code 32
(1)

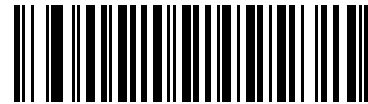

***Disable Convert Code 39 to Code 32**
(0)

Code 32 Prefix

Parameter # 231 (SSI # E7h)

Scan the appropriate bar code below to enable or disable adding the prefix character "A" to all Code 32 bar codes.

✓ **NOTE** Convert Code 39 to Code 32 must be enabled for this parameter to function.

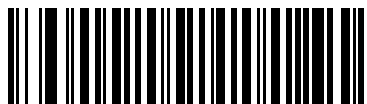

Enable Code 32 Prefix
(1)



***Disable Code 32 Prefix**
(0)

Set Lengths for Code 39

Parameter # L1 = 18 (SSI # 12h), L2 = 19 (SSI # 13h)

The length of a code refers to the number of characters (i.e., human readable characters), including check digit(s) the code contains. Set lengths for Code 39 to any length, one or two discrete lengths, or lengths within a specific range. If Code 39 Full ASCII is enabled, **Length Within a Range** or **Any Length** are the preferred options.

- ✓ **NOTE** When setting lengths for different bar code types by scanning single digit numbers, single digit numbers must always be preceded by a leading zero.
- **One Discrete Length** - Select this option to decode only Code 39 symbols containing a selected length. Select the length using the numeric bar codes in [Appendix D, Numeric Bar Codes](#). For example, to decode only Code 39 symbols with 14 characters, scan **Code 39 - One Discrete Length**, then scan **1** followed by **4**. To correct an error or change the selection, scan **Cancel** on [page D-3](#).
 - **Two Discrete Lengths** - Select this option to decode only Code 39 symbols containing either of two selected lengths. Select lengths using the numeric bar codes in [Appendix D, Numeric Bar Codes](#). For example, to decode only those Code 39 symbols containing either 2 or 14 characters, select **Code 39 - Two Discrete Lengths**, then scan **0**, **2**, **1**, and then **4**. To correct an error or change the selection, scan **Cancel** on [page D-3](#).
 - **Length Within Range** - Select this option to decode a Code 39 symbol with a specific length range. Select lengths using numeric bar codes in [Appendix D, Numeric Bar Codes](#). For example, to decode Code 39 symbols containing between 4 and 12 characters, first scan **Code 39 - Length Within Range**. Then scan **0**, **4**, **1**, and **2** (single digit numbers must always be preceded by a leading zero). To correct an error or change the selection, scan **Cancel** on [page D-3](#).
 - **Any Length** - Select this option to decode Code 39 symbols containing any number of characters within the imager's capability.



Code 39 - One Discrete Length



Code 39 - Two Discrete Lengths

Set Lengths for Code 39 (continued)



Code 39 - Length Within Range



Code 39 - Any Length

Code 39 Check Digit Verification

Parameter # 48 (SSI # 30h)

When this feature is enabled, the imager checks the integrity of all Code 39 symbols to verify that the data complies with specified check digit algorithm. Only Code 39 symbols which include a modulo 43 check digit are decoded. Enable this feature if the Code 39 symbols contain a Modulo 43 check digit.

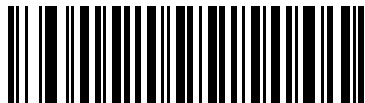

Enable Code 39 Check Digit
(1)

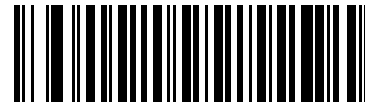

*Disable Code 39 Check Digit
(0)

Transmit Code 39 Check Digit

Parameter # 43 (SSI # 2Bh)

Scan a bar code below to transmit Code 39 data with or without the check digit.

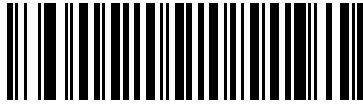

Transmit Code 39 Check Digit (Enable)
(1)

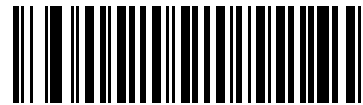

*Do Not Transmit Code 39 Check Digit (Disable)
(0)

✓ **NOTE** Code 39 Check Digit Verification must be enabled for this parameter to function.

Code 39 Full ASCII Conversion

Parameter # 17 (SSI # 11h)

Code 39 Full ASCII is a variant of Code 39 which pairs characters to encode the full ASCII character set. To enable or disable Code 39 Full ASCII, scan the appropriate bar code below.

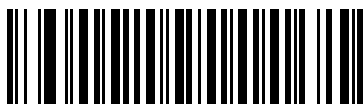

Enable Code 39 Full ASCII
(1)



*Disable Code 39 Full ASCII
(0)

✓ **NOTE** Trioptic Code 39 and Code 39 Full ASCII cannot be enabled simultaneously.

Code 39 Full ASCII to Full ASCII Correlation is host-dependent, and is therefore described in the ASCII Character Set Table for the appropriate interface. See [Appendix E, ASCII Character Set](#).

Code 39 Buffering (Scan & Store)

Parameter # 113 (SSI # 71h)

This feature allows the imager to accumulate data from multiple Code 39 symbols.

Selecting the Scan and Store option (Buffer Code 39) temporarily buffers all Code 39 symbols having a leading space as a first character for later transmission. The leading space is not buffered.

Decode of a valid Code 39 symbol with no leading space causes transmission in sequence of all buffered data in a first-in first-out format, plus transmission of the “triggering” symbol. See the following pages for further details.

When the **Do Not Buffer Code 39** option is selected, all decoded Code 39 symbols are transmitted immediately without being stored in the buffer.

This feature affects Code 39 only. If selecting **Buffer Code 39**, we recommend configuring the imager to decode Code 39 symbology only.

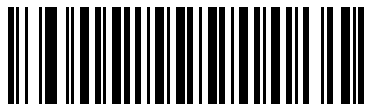

Buffer Code 39 (Enable)
(1)

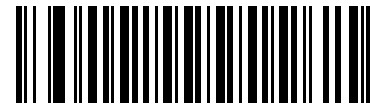

***Do Not Buffer Code 39 (Disable)**
(0)

While there is data in the transmission buffer, selecting **Do Not Buffer Code 39** is not allowed. The buffer holds 128 bytes of information.

To disable Code 39 buffering when there is data in the transmission buffer, first force the buffer transmission (see [Transmit Buffer on page 12-40](#)) or clear the buffer.

Buffer Data

To buffer data, Code 39 buffering must be enabled and a Code 39 symbol must be read with a space immediately following the start pattern.

- Unless the data overflows the transmission buffer, the imager issues a lo/hi beep to indicate successful decode and buffering. (For overflow conditions, see [Overfilling Transmission Buffer](#).)
- The imager adds the decoded data excluding the leading space to the transmission buffer.
- No transmission occurs.

Clear Transmission Buffer

To clear the transmission buffer, scan the **Clear Buffer** bar code below, which contains only a start character, a dash (minus), and a stop character.

- The imager issues a short hi/lo/hi beep.
- The imager erases the transmission buffer.
- No transmission occurs.



Clear Buffer



NOTE The Clear Buffer contains only the dash (minus) character. In order to scan this command, be sure Code 39 length is set to include length 1.

Transmit Buffer

There are two methods to transmit the Code 39 buffer.

1. Scan the **Transmit Buffer** bar code below. Only a start character, a plus (+), and a stop character.
 - The imager transmits and clears the buffer.
 - The imager issues a Lo/Hi beep.



Transmit Buffer

2. Scan a Code 39 bar code with a leading character other than a space.
 - The imager appends new decode data to buffered data.
 - The imager transmits and clears the buffer.
 - The imager signals that the buffer was transmitted with a lo/hi beep.
 - The imager transmits and clears the buffer.



NOTE The Transmit Buffer contains only a plus (+) character. In order to scan this command, be sure Code 39 length is set to include length 1.

Overfilling Transmission Buffer

The Code 39 buffer holds 128 characters. If the symbol just read results in an overflow of the transmission buffer:

- The imager indicates that the symbol was rejected by issuing three long, high beeps.
- No transmission occurs. The data in the buffer is not affected.

Attempt to Transmit an Empty Buffer

If the symbol just read was the **Transmit Buffer** symbol and the Code 39 buffer is empty:

- A short lo/hi/lo beep signals that the buffer is empty.
- No transmission occurs.
- The buffer remains empty.

Code 39 Security Level

Parameter # 750 (SSI # F3h EEh)

The imager offers four levels of decode security for Code 39. Select increasing levels of security for decreasing levels of bar code quality. There is an inverse relationship between security and imager aggressiveness, so choose only that level of security necessary for any given application.

- **Code 39 Security Level 0:** This setting allows the imager to operate in its most aggressive state, while providing sufficient security in decoding most “in-spec” bar codes.
- **Code 39 Security Level 1:** This default setting eliminates most misdecodes.
- **Code 39 Security Level 2:** Select this option if Security level 1 fails to eliminate misdecodes.
- **Code 39 Security Level 3:** If you selected Security Level 2 and misdecodes still occur, select this security level. Be advised, selecting this option is an extreme measure against mis-decoding severely out of spec bar codes. Selecting this level of security significantly impairs the decoding ability of the imager. If you need this level of security, try to improve the quality of the bar codes.



**Code 39 Security Level 0
(0)**



***Code 39 Security Level 1
(1)**



**Code 39 Security Level 2
(2)**



**Code 39 Security Level 3
(3)**

Code 93

Enable/Disable Code 93

Parameter # 9 (SSI # 09h)

To enable or disable Code 93, scan the appropriate bar code below.

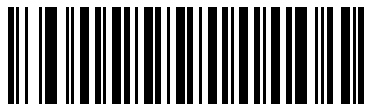

Enable Code 93
(1)



*Disable Code 93
(0)

Set Lengths for Code 93

Parameter # L1 = 26 (SSI # 1Ah), L2 = 27 (SSI # 1Bh)

The length of a code refers to the number of characters (i.e., human readable characters), including check digit(s) the code contains. Set lengths for Code 93 to any length, one or two discrete lengths, or lengths within a specific range.

- **One Discrete Length** - Select this option to decode only Code 93 symbols containing a selected length. Select the length using the numeric bar codes in [Appendix D, Numeric Bar Codes](#). For example, to decode only Code 93 symbols with 14 characters, scan **Code 93 - One Discrete Length**, then scan **1** followed by **4**. To correct an error or to change the selection, scan **Cancel** on [page D-3](#).
- **Two Discrete Lengths** - Select this option to decode only Code 93 symbols containing either of two selected lengths. Select lengths using the numeric bar codes in [Appendix D, Numeric Bar Codes](#). For example, to decode only those Code 93 symbols containing either 2 or 14 characters, select **Code 93 - Two Discrete Lengths**, then scan **0, 2, 1**, and then **4**. To correct an error or to change the selection, scan **Cancel** on [page D-3](#).
- **Length Within Range** - Select this option to decode a Code 93 symbol with a specific length range. Select lengths using the numeric bar codes in [Appendix D, Numeric Bar Codes](#). For example, to decode Code 93 symbols containing between 4 and 12 characters, first scan **Code 93 - Length Within Range**. Then scan **0, 4, 1**, and **2** (single digit numbers must always be preceded by a leading zero). To correct an error or change the selection, scan **Cancel** on [page D-3](#).
- **Any Length** - Scan this option to decode Code 93 symbols containing any number of characters within the imager's capability.

Set Lengths for Code 93 (continued)



Code 93 - One Discrete Length



Code 93 - Two Discrete Lengths



Code 93 - Length Within Range



Code 93 - Any Length

Code 11

Code 11

Parameter # 10 (SSI # 0Ah)

To enable or disable Code 11, scan the appropriate bar code below.

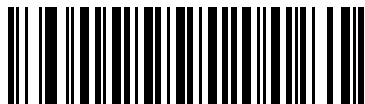

Enable Code 11
(1)



*Disable Code 11
(0)

Set Lengths for Code 11

Parameter # L1 = 28 (SSI # 1Ch), L2 = 29 (SSI # 1Dh)

The length of a code refers to the number of characters (i.e., human readable characters), including check digit(s) the code contains. Set lengths for Code 11 to any length, one or two discrete lengths, or lengths within a specific range.

- **One Discrete Length** - Select this option to decode only Code 11 symbols containing a selected length. Select the length using the numeric bar codes in [Appendix D, Numeric Bar Codes](#). For example, to decode only Code 11 symbols with 14 characters, scan **Code 11 - One Discrete Length**, then scan **1** followed by **4**. To correct an error or to change the selection, scan **Cancel** on [page D-3](#).
- **Two Discrete Lengths** - Select this option to decode only Code 11 symbols containing either of two selected lengths. Select lengths using the numeric bar codes in [Appendix D, Numeric Bar Codes](#). For example, to decode only those Code 11 symbols containing either 2 or 14 characters, select **Code 11 - Two Discrete Lengths**, then scan **0, 2, 1**, and then **4**. To correct an error or to change the selection, scan **Cancel** on [page D-3](#).
- **Length Within Range** - Select this option to decode a Code 11 symbol with a specific length range. Select lengths using numeric bar codes in [Appendix D, Numeric Bar Codes](#). For example, to decode Code 11 symbols containing between 4 and 12 characters, first scan **Code 11 - Length Within Range**. Then scan **0, 4, 1**, and **2** (single digit numbers must always be preceded by a leading zero). To correct an error or change the selection, scan **Cancel** on [page D-3](#).
- **Any Length** - Scan this option to decode Code 11 symbols containing any number of characters within the imager's capability.

Set Lengths for Code 11 (continued)



Code 11 - One Discrete Length



Code 11 - Two Discrete Lengths



Code 11 - Length Within Range



Code 11 - Any Length

Code 11 Check Digit Verification

Parameter # 52 (SSI # 34h)

This feature allows the imager to check the integrity of all Code 11 symbols to verify that the data complies with the specified check digit algorithm. This selects the check digit mechanism for the decoded Code 11 bar code. The options are to check for one check digit, check for two check digits, or disable the feature.

To enable this feature, scan the bar code below corresponding to the number of check digits encoded in the Code 11 symbols.

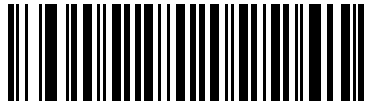

***Disable**
(0)



One Check Digit
(1)

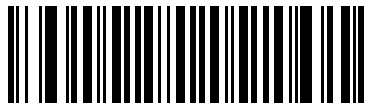

Two Check Digits
(2)

Transmit Code 11 Check Digits

Parameter # 47 (SSI # 2Fh)

This feature selects whether or not to transmit the Code 11 check digit(s).

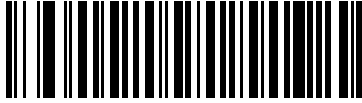

Transmit Code 11 Check Digit(s) (Enable)
(1)

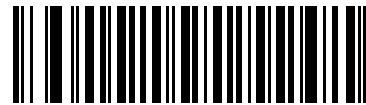

*Do Not Transmit Code 11 Check Digit(s) (Disable)
(0)



NOTE Code 11 Check Digit Verification must be enabled for this parameter to function.

Interleaved 2 of 5 (ITF)

Enable/Disable Interleaved 2 of 5

Parameter # 6 (SSI # 06h)

To enable or disable Interleaved 2 of 5, scan the appropriate bar code below, and select an Interleaved 2 of 5 length from the following pages.



*Enable Interleaved 2 of 5
(1)



Disable Interleaved 2 of 5
(0)

Set Lengths for Interleaved 2 of 5

Parameter # L1 = 22 (SSI # 16h), L2 = 23 (SSI # 17h)

The length of a code refers to the number of characters (i.e., human readable characters), including check digit(s) the code contains. Set lengths for I 2 of 5 to any length, one or two discrete lengths, or lengths within a specific range.

- **One Discrete Length** - Select this option to decode only I 2 of 5 symbols containing a selected length. Select the length using the numeric bar codes in [Appendix D, Numeric Bar Codes](#). For example, to decode only I 2 of 5 symbols with 14 characters, scan **I 2 of 5 - One Discrete Length**, then scan **1** followed by **4**. To correct an error or to change the selection, scan **Cancel** on [page D-3](#).
- **Two Discrete Lengths** - Select this option to decode only I 2 of 5 symbols containing either of two selected lengths. Select lengths using the numeric bar codes in [Appendix D, Numeric Bar Codes](#). For example, to decode only those I 2 of 5 symbols containing either 2 or 14 characters, select **I 2 of 5 - Two Discrete Lengths**, then scan **0, 2, 1**, and then **4**. To correct an error or to change the selection, scan **Cancel** on [page D-3](#).
- **Length Within Range** - Select this option to decode an I 2 of 5 symbol with a specific length range. Select lengths using numeric bar codes in [Appendix D, Numeric Bar Codes](#). For example, to decode I 2 of 5 symbols containing between 4 and 12 characters, first scan **I 2 of 5 - Length Within Range**. Then scan **0, 4, 1**, and **2** (single digit numbers must always be preceded by a leading zero). To correct an error or change the selection, scan **Cancel** on [page D-3](#).
- **Any Length** - Scan this option to decode I 2 of 5 symbols containing any number of characters within the imager's capability.

✓ **NOTE** Due to the construction of the I 2 of 5 symbology, it is possible for a scan line covering only a portion of the code to be interpreted as a complete scan, yielding less data than is encoded in the bar code. To prevent this, select specific lengths (I 2 of 5 - One Discrete Length - Two Discrete Lengths) for I 2 of 5 applications.



I 2 of 5 - One Discrete Length



I 2 of 5 - Two Discrete Lengths

Set Lengths for Interleaved 2 of 5 (continued)



I 2 of 5 - Length Within Range



I 2 of 5 - Any Length

I 2 of 5 Check Digit Verification

Parameter # 49 (SSI # 31h)

When this feature is enabled, the imager checks the integrity of all I 2 of 5 symbols to verify the data complies with either the specified Uniform Symbology Specification (USS), or the Optical Product Code Council (OPCC) check digit algorithm.



*Disable
(0)



USS Check Digit
(1)



OPCC Check Digit
(2)

Transmit I 2 of 5 Check Digit

Parameter # 44 (SSI # 2Ch)

Scan the appropriate bar code below to transmit I 2 of 5 data with or without the check digit.



Transmit I 2 of 5 Check Digit (Enable)
(1)

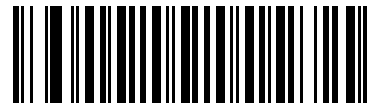

*Do Not Transmit I 2 of 5 Check Digit (Disable)
(0)

Convert I 2 of 5 to EAN-13

Parameter # 82 (SSI # 52h)

Enable this parameter to convert 14-character I 2 of 5 codes to EAN-13, and transmit to the host as EAN-13. To accomplish this, the I 2 of 5 code must be enabled, and the code must have a leading zero and a valid EAN-13 check digit.

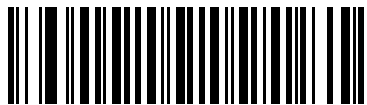

Convert I 2 of 5 to EAN-13 (Enable)
(1)



*Do Not Convert I 2 of 5 to EAN-13 (Disable)
(0)

I 2 of 5 Security Level

Parameter # 1121

Interleaved 2 of 5 bar codes are vulnerable to misdecodes, particularly when I 2 of 5 Lengths is set to **Any Length**. The imager offers four levels of decode security for Interleaved 2 of 5 bar codes. There is an inverse relationship between security and imager aggressiveness. Increasing the level of security can reduce scanning aggressiveness, so select only the level of security necessary.

- **I 2 of 5 Security Level 0:** This setting allows the imager to operate in its most aggressive state, while providing sufficient security in decoding most in-spec bar codes.
- **I 2 of 5 Security Level 1:** A bar code must be successfully read twice, and satisfy certain safety requirements before being decoded. This default setting eliminates most misdecodes.
- **I 2 of 5 Security Level 2:** Select this option with greater bar code security requirements if **Security Level 1** fails to eliminate misdecodes.
- **I 2 of 5 Security Level 3:** If you selected **Security Level 2**, and misdecodes still occur, select this security level. The highest safety requirements are applied. A bar code must be successfully read three times before being decoded.

✓ **NOTE** Selecting this option is an extreme measure against mis-decoding severely out-of-spec bar codes. Selecting this level of security significantly impairs the decoding ability of the imager. If this level of security is required, try to improve the quality of the bar codes.

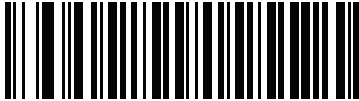

I 2 of 5 Security Level 0
(0)

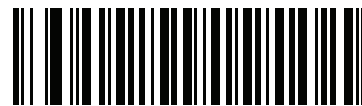

*I 2 of 5 Security Level 1
(1)



I 2 of 5 Security Level 2
(2)



I 2 of 5 Security Level 3
(3)

Discrete 2 of 5 (DTF)

Enable/Disable Discrete 2 of 5

Parameter # 5 (SSI # 05h)

To enable or disable Discrete 2 of 5, scan the appropriate bar code below.

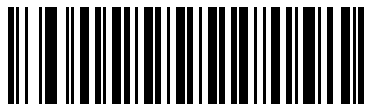

Enable Discrete 2 of 5
(1)



*Disable Discrete 2 of 5
(0)

Set Lengths for Discrete 2 of 5

Parameter # L1 = 20 (SSI # 14h), L2 = 21 (SSI # 15h)

The length of a code refers to the number of characters (i.e., human readable characters), including check digit(s) the code contains. Set lengths for D 2 of 5 to any length, one or two discrete lengths, or lengths within a specific range.

- **One Discrete Length** - Select this option to decode only D 2 of 5 symbols containing a selected length. Select the length using the numeric bar codes in [Appendix D, Numeric Bar Codes](#). For example, to decode only D 2 of 5 symbols with 14 characters, scan **D 2 of 5 - One Discrete Length**, then scan **1** followed by **4**. To correct an error or to change the selection, scan **Cancel** on [page D-3](#).
- **Two Discrete Lengths** - Select this option to decode only D 2 of 5 symbols containing either of two selected lengths. Select lengths using the numeric bar codes in [Appendix D, Numeric Bar Codes](#). For example, to decode only those D 2 of 5 symbols containing either 2 or 14 characters, select **D 2 of 5 - Two Discrete Lengths**, then scan **0, 2, 1**, and then **4**. To correct an error or to change the selection, scan **Cancel** on [page D-3](#).
- **Length Within Range** - Select this option to decode a D 2 of 5 symbol with a specific length range. Select lengths using numeric bar codes in [Appendix D, Numeric Bar Codes](#). For example, to decode D 2 of 5 symbols containing between 4 and 12 characters, first scan **D 2 of 5 - Length Within Range**. Then scan **0, 4, 1**, and **2** (single digit numbers must always be preceded by a leading zero). To correct an error or change the selection, scan **Cancel** on [page D-3](#).
- **Any Length** - Scan this option to decode D 2 of 5 symbols containing any number of characters within the imager's capability.

Set Lengths for Discrete 2 of 5 (continued)



NOTE Due to the construction of the D 2 of 5 symbology, it is possible for a scan line covering only a portion of the code to be interpreted as a complete scan, yielding less data than is encoded in the bar code. To prevent this, select specific lengths (D 2 of 5 - One Discrete Length - Two Discrete Lengths) for D 2 of 5 applications.



D 2 of 5 - One Discrete Length



D 2 of 5 - Two Discrete Lengths



D 2 of 5 - Length Within Range



D 2 of 5 - Any Length

Codabar (NW - 7)

Enable/Disable Codabar

Parameter # 7 (SSI # 07h)

To enable or disable Codabar, scan the appropriate bar code below.

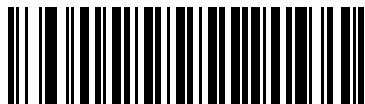

Enable Codabar
(1)



*Disable Codabar
(0)

Set Lengths for Codabar

Parameter # L1 = 24 (SSI # 18h), L2 = 25 (SSI # 19h)

The length of a code refers to the number of characters (i.e., human readable characters), including check digit(s) the code contains. Set lengths for Codabar to any length, one or two discrete lengths, or lengths within a specific range.

- **One Discrete Length** - Select this option to decode only Codabar symbols containing a selected length. Select the length using the numeric bar codes in [Appendix D, Numeric Bar Codes](#). For example, to decode only Codabar symbols with 14 characters, scan **Codabar - One Discrete Length**, then scan **1** followed by **4**. To correct an error or to change the selection, scan **Cancel** on [page D-3](#).
- **Two Discrete Lengths** - Select this option to decode only Codabar symbols containing either of two selected lengths. Select lengths using the numeric bar codes in [Appendix D, Numeric Bar Codes](#). For example, to decode only Codabar symbols containing either 2 or 14 characters, select **Codabar - Two Discrete Lengths**, then scan **0, 2, 1**, and then **4**. To correct an error or to change the selection, scan **Cancel** on [page D-3](#).
- **Length Within Range** - Select this option to decode a Codabar symbol with a specific length range. Select lengths using numeric bar codes in [Appendix D, Numeric Bar Codes](#). For example, to decode Codabar symbols containing between 4 and 12 characters, first scan **Codabar - Length Within Range**. Then scan **0, 4, 1**, and **2** (single digit numbers must always be preceded by a leading zero). To correct an error or change the selection, scan **Cancel** on [page D-3](#).
- **Any Length** - Scan this option to decode Codabar symbols containing any number of characters within the imager's capability.

Set Lengths for Codabar (continued)



Codabar - One Discrete Length



Codabar - Two Discrete Lengths



Codabar - Length Within Range



Codabar - Any Length

CLSI Editing

Parameter # 54 (SSI # 36h)

When enabled, this parameter strips the start and stop characters and inserts a space after the first, fifth, and tenth characters of a 14-character Codabar symbol. Enable this feature if the host system requires this data format.

✓ **NOTE** Symbol length does not include start and stop characters.

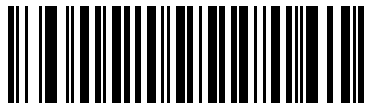

Enable CLSI Editing
(1)

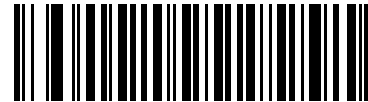

*Disable CLSI Editing
(0)

NOTIS Editing

Parameter # 55 (SSI # 37h)

When enabled, this parameter strips the start and stop characters from a decoded Codabar symbol. Enable this feature if the host system requires this data format.

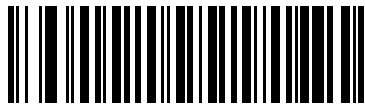

Enable NOTIS Editing
(1)

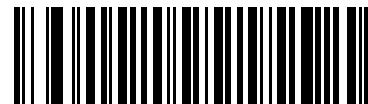

*Disable NOTIS Editing
(0)

Codabar Upper or Lower Case Start/Stop Characters Transmission

Parameter # 855 (SSI # F2h 57h)

Select whether to transmit upper case or lower case Codabar start/stop characters.



*Upper Case
(0)



Lower Case
(1)

MSI

Enable/Disable MSI

Parameter # 11 (SSI # 0Bh)

To enable or disable MSI, scan the appropriate bar code below.

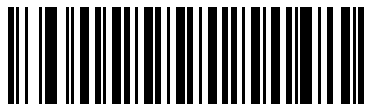

Enable MSI
(1)



*Disable MSI
(0)

Set Lengths for MSI

Parameter # L1 = 30 (SSI # 1Eh), L2 = 31 (SSI # 1Fh)

The length of a code refers to the number of characters (i.e., human readable characters), including check digit(s) the code contains. Set lengths for MSI to any length, one or two discrete lengths, or lengths within a specific range.

- One Discrete Length** - Select this option to decode only MSI symbols containing a selected length. Select the length using the numeric bar codes in [Appendix D, Numeric Bar Codes](#). For example, to decode only MSI symbols with 14 characters, scan **MSI - One Discrete Length**, then scan **1** followed by **4**. To correct an error or to change the selection, scan **Cancel** on [page D-3](#).
- Two Discrete Lengths** - Select this option to decode only MSI symbols containing either of two selected lengths. Select lengths using the numeric bar codes in [Appendix D, Numeric Bar Codes](#). For example, to decode only MSI symbols containing either 2 or 14 characters, select **MSI - Two Discrete Lengths**, then scan **0, 2, 1**, and then **4**. To correct an error or to change the selection, scan **Cancel** on [page D-3](#).
- Length Within Range** - Select this option to decode a MSI symbol with a specific length range. Select lengths using numeric bar codes in [Appendix D, Numeric Bar Codes](#). For example, to decode MSI symbols containing between 4 and 12 characters, first scan **MSI - Length Within Range**. Then scan **0, 4, 1**, and **2** (single digit numbers must always be preceded by a leading zero). To correct an error or change the selection, scan **Cancel** on [page D-3](#).
- Any Length** - Scan this option to decode MSI symbols containing any number of characters within the imager's capability.

Set Lengths for MSI (continued)

- ✓ **NOTE** Due to the construction of the MSI symbology, it is possible for a scan line covering only a portion of the code to be interpreted as a complete scan, yielding less data than is encoded in the bar code. To prevent this, select specific lengths (MSI - One Discrete Length - Two Discrete Lengths) for MSI applications.

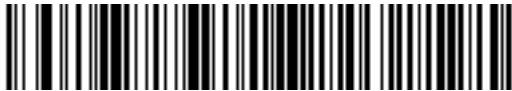

MSI - One Discrete Length



MSI - Two Discrete Lengths

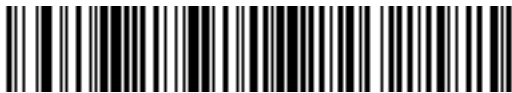

MSI - Length Within Range

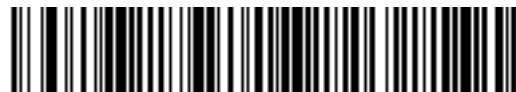

MSI - Any Length

MSI Check Digits

Parameter # 50 (SSI # 32h)

With MSI symbols, one check digit is mandatory and always verified by the reader. The second check digit is optional. If the MSI codes include two check digits, scan the **Two MSI Check Digits** bar code to enable verification of the second check digit.

See [MSI Check Digit Algorithm on page 12-62](#) for the selection of second digit algorithms.

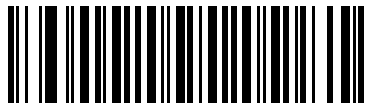

***One MSI Check Digit
(0)**

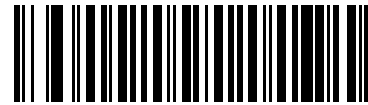

**Two MSI Check Digits
(1)**

Transmit MSI Check Digit(s)

Parameter # 46 (SSI # 2Eh)

Scan a bar code below to transmit MSI data with or without the check digit.

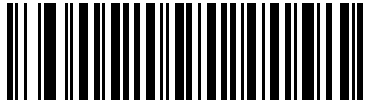

Transmit MSI Check Digit(s) (Enable)
(1)

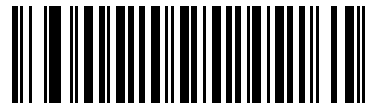

*Do Not Transmit MSI Check Digit(s) (Disable)
(0)

MSI Check Digit Algorithm

Parameter # 51 (SSI # 33h)

Two algorithms are possible for the verification of the second MSI check digit. Select the bar code below corresponding to the algorithm used to encode the check digit.

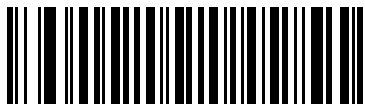

MOD 11/MOD 10
(0)



*MOD 10/MOD 10
(1)

Chinese 2 of 5

Enable/Disable Chinese 2 of 5

Parameter # 408 (SSI # F0h 98h)

To enable or disable Chinese 2 of 5, scan the appropriate bar code below.



Enable Chinese 2 of 5
(1)



*Disable Chinese 2 of 5
(0)

Matrix 2 of 5

Enable/Disable Matrix 2 of 5

Parameter # 618 (SSI # F1h 6Ah)

To enable or disable Matrix 2 of 5, scan the appropriate bar code below.



Enable Matrix 2 of 5
(1)



*Disable Matrix 2 of 5
(0)

Set Lengths for Matrix 2 of 5

Parameter # L1 = 619 (SSI # F1h 6Bh), L2 = 620 (SSI # F1h 6Ch)

The length of a code refers to the number of characters (i.e., human readable characters), including check digit(s) the code contains. Set lengths for Matrix 2 of 5 to any length, one or two discrete lengths, or lengths within a specific range.

- **One Discrete Length** - Select this option to decode only Matrix 2 of 5 symbols containing a selected length. Select the length using the numeric bar codes in [Appendix D, Numeric Bar Codes](#). For example, to decode only Matrix 2 of 5 symbols with 14 characters, scan **Matrix 2 of 5 - One Discrete Length**, then scan **1** followed by **4**. To correct an error or to change the selection, scan [Cancel on page D-3](#).
- **Two Discrete Lengths** - Select this option to decode only Matrix 2 of 5 symbols containing either of two selected lengths. Select lengths using the numeric bar codes in [Appendix D, Numeric Bar Codes](#). For example, to decode only Matrix 2 of 5 symbols containing either 2 or 14 characters, select **Matrix 2 of 5 - Two Discrete Lengths**, then scan **0, 2, 1**, and then **4**. To correct an error or to change the selection, scan [Cancel on page D-3](#).
- **Length Within Range** - Select this option to decode a Matrix 2 of 5 symbol with a specific length range. Select lengths using the numeric bar codes in [Appendix D, Numeric Bar Codes](#). For example, to decode Matrix 2 of 5 symbols containing between 4 and 12 characters, first scan **Matrix 2 of 5 - Length Within Range**. Then scan **0, 4, 1**, and **2** (enter a leading zero for single digit numbers). To correct an error or change the selection, scan [Cancel on page D-3](#).
- **Any Length** - Scan this option to decode Matrix 2 of 5 symbols containing any number of characters within the imager's capability.



*Matrix 2 of 5 - One Discrete Length



Matrix 2 of 5 - Two Discrete Lengths



Matrix 2 of 5 - Length Within Range



Matrix 2 of 5 - Any Length

Matrix 2 of 5 Check Digit

Parameter # 622 (SSI # F1h 6Eh)

The check digit is the last character of the symbol used to verify the integrity of the data. Scan the appropriate bar code below to transmit the bar code data with or without the Matrix 2 of 5 check digit.



Enable Matrix 2 of 5 Check Digit
(1)



*Disable Matrix 2 of 5 Check Digit
(0)

Transmit Matrix 2 of 5 Check Digit

Parameter # 623 (SSI # F1h 6Fh)

Scan a bar code below to transmit Matrix 2 of 5 data with or without the check digit.



Transmit Matrix 2 of 5 Check Digit
(1)



*Do Not Transmit Matrix 2 of 5 Check Digit
(0)

Korean 3 of 5

Enable/Disable Korean 3 of 5

Parameter # 581 (SSI # F1h 45h)

To enable or disable Korean 3 of 5, scan the appropriate bar code below.

✓ **NOTE** The length for Korean 3 of 5 is fixed at 6.

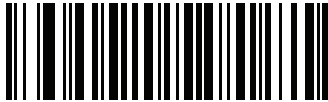

Enable Korean 3 of 5
(1)

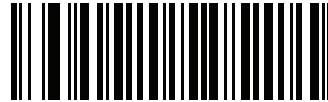

***Disable Korean 3 of 5**
(0)

Inverse 1D

Parameter # 586 (SSI # F1h 4Ah)

This parameter sets the 1D inverse imager setting. Options are:

- **Regular Only** - the imager decodes regular 1D bar codes only.
- **Inverse Only** - the imager decodes inverse 1D bar codes only.
- **Inverse Autodetect** - the imager decodes both regular and inverse 1D bar codes.



*Regular
(0)



Inverse Only
(1)



Inverse Autodetect
(2)
(Default for DS457-DP Only)

Postal Codes

US Postnet

Parameter # 89 (SSI # 59h)

To enable or disable US Postnet, scan the appropriate bar code below.



**Enable US Postnet
(1)**



***Disable US Postnet
(0)**

US Planet

Parameter # 90 (SSI # 5Ah)

To enable or disable US Planet, scan the appropriate bar code below.



**Enable US Planet
(1)**



***Disable US Planet
(0)**

Transmit US Postal Check Digit

Parameter # 95 (SSI # 5Fh)

Select whether to transmit US Postal data, which includes both US Postnet and US Planet, with or without the check digit.

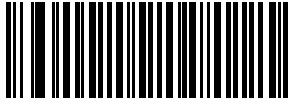

***Transmit US Postal Check Digit
(1)**

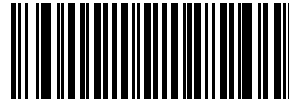

**Do Not Transmit US Postal Check Digit
(0)**

UK Postal

Parameter # 91 (SSI # 5Bh)

To enable or disable UK Postal, scan the appropriate bar code below.



**Enable UK Postal
(1)**



***Disable UK Postal
(0)**

Transmit UK Postal Check Digit

Parameter # 96 (SSI # 60h)

Select whether to transmit UK Postal data with or without the check digit.



***Transmit UK Postal
Check Digit
(1)**



**Do Not Transmit UK Postal Check Digit
(0)**

Japan Postal

Parameter # 290 (SSI # F0h, 22h)

To enable or disable Japan Postal, scan the appropriate bar code below.



**Enable Japan Postal
(1)**



***Disable Japan Postal
(0)**

Australia Post**Parameter # 291 (SSI # F0h, 23h)**

To enable or disable Australia Post, scan the appropriate bar code below.



**Enable Australia Post
(1)**



***Disable Australia Post
(0)**

Australia Post Format

Parameter # 718 (SSI # F1h, CEh)

To select one of the following formats for Australia Post, scan the appropriate bar code below:

- **Autodiscriminate** (or Smart mode) - Attempt to decode the Customer Information Field using the N and C Encoding Tables.

✓ **NOTE** This option increases the risk of misdecodes because the encoded data format does not specify the Encoding Table used for encoding.

- **Raw Format** - Output raw bar patterns as a series of numbers 0 through 3.
- **Alphanumeric Encoding** - Decode the Customer Information Field using the C Encoding Table.
- **Numeric Encoding** - Decode the Customer Information Field using the N Encoding Table.

For more information on Australia Post Encoding Tables, refer to the *Australia Post Customer Barcoding Technical Specifications* available at <http://www.auspost.com.au>.



*Autodiscriminate
(0)



Raw Format
(1)



Alphanumeric Encoding
(2)



Numeric Encoding
(3)

Netherlands KIX Code

Parameter # 326 (SSI # F0h, 46h)

To enable or disable Netherlands KIX Code, scan the appropriate bar code below.



**Enable Netherlands KIX Code
(1)**



***Disable Netherlands KIX Code
(0)**

USPS 4CB/One Code/Intelligent Mail

Parameter # 592 (SSI # F1h 50h)

To enable or disable USPS 4CB/One Code/Intelligent Mail, scan the appropriate bar code below.



Enable USPS 4CB/One Code/Intelligent Mail
(1)



*Disable USPS 4CB/One Code/Intelligent Mail
(0)

UPU FICS Postal

Parameter # 611 (SSI # F1h 63h)

To enable or disable UPU FICS Postal, scan the appropriate bar code below.

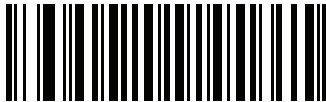

Enable UPU FICS Postal
(1)

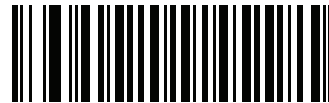

*Disable UPU FICS Postal
(0)

GS1 DataBar (formerly RSS, Reduced Space Symbology)

GS1 DataBar types are:

- GS1 DataBar Omnidirectional
- GS1 DataBar Truncated
- GS1 DataBar Stacked
- GS1 DataBar Stacked Omnidirectional
- GS1 DataBar Limited
- GS1 DataBar Expanded
- GS1 DataBar Expanded Stacked

Scan the appropriate bar codes to enable or disable each type of GS1 DataBar.

GS1 DataBar

Parameter # 338 (SSI # F0h 52h)

Scan the appropriate bar code below to enable or disable the following code types:

- GS1 DataBar Omnidirectional
- GS1 DataBar Truncated
- GS1 DataBar Stacked
- GS1 DataBar Stacked Omnidirectional

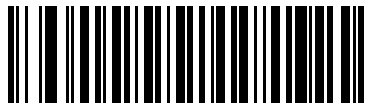

***Enable GS1 DataBar
(1)**



**Disable GS1 DataBar
(0)**

GS1 DataBar Limited

Parameter # 339 (SSI # F0h 53h)



***Enable GS1 DataBar Limited
(1)**

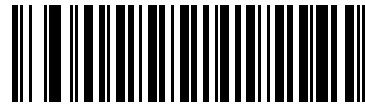

**Disable GS1 DataBar Limited
(0)**

GS1 DataBar Limited Security Level

Parameter # 728 (SSI # F1h D8h)

The imager offers four levels of decode security for GS1 DataBar Limited bar codes. There is an inverse relationship between security and decoder aggressiveness. Increasing the level of security can reduce aggressiveness in scanning, so only choose the level of security necessary.

- Level 1 – No clear margin required. This complies with the original GS1 standard, yet might result in erroneous decoding of the DataBar Limited bar code when scanning some UPC symbols that start with the digits “9” and “7”.
- Level 2 – Automatic risk detection. This level of security may result in erroneous decoding of DataBar Limited bar codes when scanning some UPC symbols. If a misdecode is detected, the decoder operates in Level 3 or Level 1.
- Level 3 – Security level reflects newly proposed GS1 standard that requires a 5X trailing clear margin.
- Level 4 – Security level extends beyond the standard required by GS1. This level of security requires a 5X leading and trailing clear margin.



Security Level 1
(1)

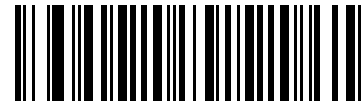

Security Level 2
(2)



*Security Level 3
(3)



Security Level 4
(4)

GS1 DataBar Expanded

Parameter # 340 (SSI # F0h 54h)

Scan the appropriate bar code below to enable or disable the following code types:

- GS1 DataBar Expanded
- GS1 DataBar Expanded Stacked



***Enable GS1 DataBar Expanded
(1)**

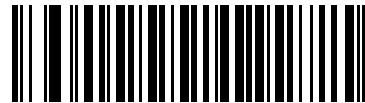

**Disable GS1 DataBar Expanded
(0)**

Convert GS1 DataBar to UPC/EAN

Parameter # 397 (SSI # F0h, 8Dh)

This parameter only applies to GS1 DataBar Omnidirectional and GS1 DataBar Limited symbols not decoded as part of a Composite symbol. Enable this to strip the leading '010' from GS1 DataBar Omnidirectional and GS1 DataBar Limited symbols encoding a single zero as the first digit, and report the bar code as EAN-13.

For bar codes beginning with two or more zeros but not six zeros, this parameter strips the leading '0100' and reports the bar code as UPC-A. The UPC-A Preamble parameter that transmits the system character and country code applies to converted bar codes. Note that neither the system character nor the check digit can be stripped.

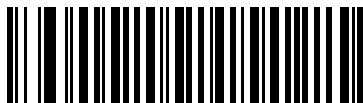

**Enable Convert GS1 DataBar to UPC/EAN
(1)**

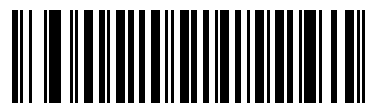

***Disable Convert GS1 DataBar to UPC/EAN
(0)**

Composite

Composite CC-C

Parameter # 341 (SSI # F0h 55h)

Scan a bar code below to enable or disable Composite bar codes of type CC-C.

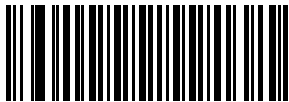

Enable CC-C
(1)



*Disable CC-C
(0)

Composite CC-A/B

Parameter # 342 (SSI # F0h 56h)

Scan a bar code below to enable or disable Composite bar codes of type CC-A/B.



Enable CC-A/B
(1)



*Disable CC-A/B
(0)

Composite TLC-39

Parameter # 371 (SSI # F0h 73h)

Scan a bar code below to enable or disable Composite bar codes of type TLC-39.

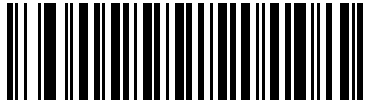

Enable TLC39
(1)

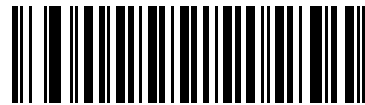

***Disable TLC39**
(0)

UPC Composite Mode

Parameter # 344 (SSI # F0h 58h)

UPC symbols can be “linked” with a 2D symbol during transmission as if they were one symbol. There are three options for these symbols:

- Select **UPC Never Linked** to transmit UPC bar codes regardless of whether a 2D symbol is detected.
- Select **UPC Always Linked** to transmit UPC bar codes and the 2D portion. If 2D is not present, the UPC bar code does not transmit.
- If Autodiscriminate UPC Composites is selected, the DS457 determines if there is a 2D portion, then transmits the UPC, as well as the 2D portion if present.



***UPC Never Linked
(0)**

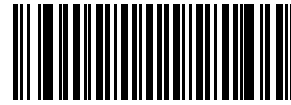

**UPC Always Linked
(1)**

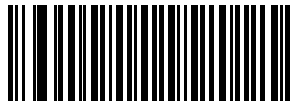

**Autodiscriminate UPC Composites
(2)**

Composite Beep Mode

Parameter # 398 (SSI # F0h, 8Eh)

To select the number of decode beeps when a composite bar code is decoded, scan the appropriate bar code.

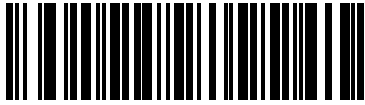

Single Beep after both are decoded
(0)

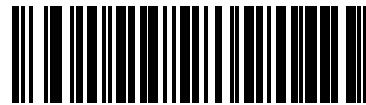

*Beep as each code type is decoded
(1)

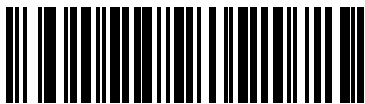

Double Beep after both are decoded
(2)

GS1-128 Emulation Mode for UCC/EAN Composite Codes

Parameter # 427 (SSI # F0h, ABh)

Select whether to enable or disable this mode.



Enable GS1-128 Emulation Mode for
UCC/EAN Composite Codes
(1)



*Disable GS1-128 Emulation Mode for
UCC/EAN Composite Codes
(0)

2D Symbologies

Enable/Disable PDF417

Parameter # 15 (SSI # 0Fh)

To enable or disable PDF417, scan the appropriate bar code below.



***Enable PDF417
(1)**



**Disable PDF417
(0)**

Enable/Disable MicroPDF417

Parameter # 227 (SSI # E3h)

To enable or disable MicroPDF417, scan the appropriate bar code below.



**Enable MicroPDF417
(1)**



***Disable MicroPDF417
(0)**

Code 128 Emulation

Parameter # 123 (SSI # 7Bh)

When this parameter is enabled, the imager transmits data from certain MicroPDF417 symbols as if it was encoded in Code 128 symbols. Transmit AIM Symbology Identifiers must be enabled for this parameter to work.

If Code 128 Emulation is enabled, these MicroPDF417 symbols are transmitted with one of the following prefixes:

-]C1 if the first codeword is 903-905
-]C2 if the first codeword is 908 or 909
-]C0 if the first codeword is 910 or 911

If disabled, they are transmitted with one of the following prefixes:

-]L3 if the first codeword is 903-905
-]L4 if the first codeword is 908 or 909
-]L5 if the first codeword is 910 or 911

Scan a bar code below to enable or disable Code 128 Emulation.



NOTE Linked MicroPDF codewords 906, 907, 912, 914, and 915 are not supported. Use GS1 Composites instead.



**Enable Code 128 Emulation
(1)**



***Disable Code 128 Emulation
(0)**

Data Matrix

Parameter # 292 (SSI # F0h, 24h)

To enable or disable Data Matrix, scan the appropriate bar code below.



***Enable Data Matrix
(1)**



**Disable Data Matrix
(0)**

Data Matrix Inverse

Parameter # 588 (SSI # F1h 4Ch)

This parameter sets the Data Matrix inverse imager setting. Options are:

- **Regular Only** - the imager decodes regular Data Matrix bar codes only.
- **Inverse Only** - the imager decodes inverse Data Matrix bar codes only.
- **Inverse Autodetect** - the imager decodes both regular and inverse Data Matrix bar codes.



***Regular**
(0)



Inverse Only
(1)



Inverse Autodetect
(2)
(Default for DS457-DP Only)

Decode Mirror Images (Data Matrix Only)

Parameter # 537 (SSI # F1h 19h)

Select an option for decoding mirror image Data Matrix bar codes:

- Always - decode only Data Matrix bar codes that are mirror images
- Never - do not decode Data Matrix bar codes that are mirror images
- Auto - decode both mirrored and unmirrored Data Matrix bar codes.



Never
(0)



Always
(1)



***Auto**
(2)

Maxicode

Parameter # 294 (SSI # F0h, 26h)

To enable or disable Maxicode, scan the appropriate bar code below.



**Enable Maxicode
(1)**



***Disable Maxicode
(0)**

QR Code

Parameter # 293 (SSI # F0h, 25h)

To enable or disable QR Code, scan the appropriate bar code below.



***Enable QR Code
(1)**



**Disable QR Code
(0)**

QR Inverse

Parameter # 587 (SSI # F1h 4Bh)

This parameter sets the QR inverse imager setting. Options are:

- **Regular Only** - the imager decodes regular QR bar codes only.
- **Inverse Only** - the imager decodes inverse QR bar codes only.
- **Inverse Autodetect** - the imager decodes both regular and inverse QR bar codes.



***Regular
(0)**



**Inverse Only
(1)**



**Inverse Autodetect
(2)**

MicroQR

Parameter # 573 (SSI # F1h 3Dh)

To enable or disable MicroQR, scan the appropriate bar code below.



***Enable MicroQR
(1)**



**Disable MicroQR
(0)**

Aztec

Parameter # 574 (SSI # F1h 3Eh)

To enable or disable Aztec, scan the appropriate bar code below.



***Enable Aztec
(1)**



**Disable Aztec
(0)**

Aztec Inverse

Parameter # 589 (SSI # F1h 4Dh)

This parameter sets the Aztec inverse imager setting. Options are:

- **Regular Only** - the imager decodes regular Aztec bar codes only.
- **Inverse Only** - the imager decodes inverse Aztec bar codes only.
- **Inverse Autodetect** - the imager decodes both regular and inverse Aztec bar codes.



Regular
(0)



Inverse Only
(1)



***Inverse Autodetect**
(2)

Redundancy Level

Parameter # 78 (SSI # 4Eh)

The imager offers four levels of decode redundancy. Select higher redundancy levels for decreasing levels of bar code quality. As redundancy levels increase, the imager's aggressiveness decreases.

Select the redundancy level appropriate for the bar code quality.

Redundancy Level 1

The following code types must be successfully read twice before being decoded:

Code Type	Code Length
Codabar	8 characters or less
MSI	4 characters or less
D 2 of 5	8 characters or less
I 2 of 5	8 characters or less

Redundancy Level 2

The following code types must be successfully read twice before being decoded:

Code Type	Code Length
All	All

Redundancy Level 3

Code types other than the following must be successfully read twice before being decoded. The following codes must be read three times:

Code Type	Code Length
MSI Plessey	4 characters or less
D 2 of 5	8 characters or less
I 2 of 5	8 characters or less
Codabar	8 characters or less

Redundancy Level 4

The following code types must be successfully read three times before being decoded:

Code Type	Code Length
All	All

Redundancy Level (continued)

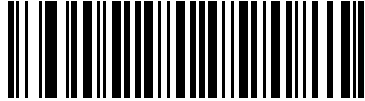

***Redundancy Level 1
(1)**

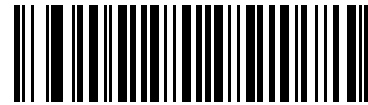

**Redundancy Level 2
(2)**

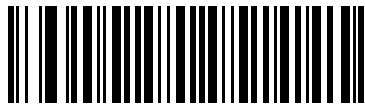

**Redundancy Level 3
(3)**

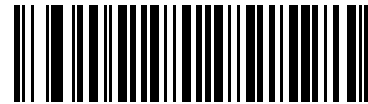

**Redundancy Level 4
(4)**

Security Level

Parameter # 77 (SSI # 4Dh)

The imager offers four levels of decode security for delta bar codes, which include the Code 128 family, UPC/EAN, and Code 93. Select increasing levels of security for decreasing levels of bar code quality. There is an inverse relationship between security and imager aggressiveness, so choose only that level of security necessary for any given application.

- **Security Level 0:** This setting allows the imager to operate in its most aggressive state, while providing sufficient security in decoding most “in-spec” bar codes.
- **Security Level 1:** Select this option if misdecodes occur. This default setting should eliminate most misdecodes.
- **Security Level 2:** Select this option if Security level 1 fails to eliminate misdecodes.
- **Security Level 3:** If Security Level 2 was selected and misdecodes still occur, select this security level. Be advised, selecting this option is an extreme measure against mis-decoding severely out of spec bar codes. Selecting this level of security significantly impairs the decoding ability of the imager. If this level of security is necessary, try to improve the quality of the bar codes.

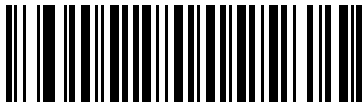

Security Level 0
(0)



*Security Level 1
(1)

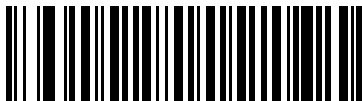

Security Level 2
(2)



Security Level 3
(3)

Intercharacter Gap Size

Parameter # 381 (SSI # F0h, 7Dh)

The Code 39 and Codabar symbologies have an intercharacter gap that is typically quite small. Due to various bar code-printing technologies, this gap can grow larger than the maximum size allowed, preventing the imager from decoding the symbol. If this problem occurs, scan the **Large Intercharacter Gaps** parameter to tolerate these out-of-specification bar codes.



***Normal Intercharacter Gaps**
(6)



Large Intercharacter Gaps
(10)

Macro PDF Features

Macro PDF is a special feature for concatenating multiple PDF symbols into one file. The imager can decode symbols that are encoded with this feature, and can store more than 64 kb of decoded data stored in up to 50 Macro PDF symbols.



CAUTION When printing, keep each Macro PDF sequence separate, as each sequence has unique identifiers. Do not mix bar codes from several Macro PDF sequences, even if they encode the same data. When scanning Macro PDF sequences, scan the entire Macro PDF sequence without interruption.

Macro PDF User Indications

In this mode the imager provides the following feedback.

Table 12-2 Macro PDF User Indications

User Scans	Passthrough All Symbols		Transmit Any Symbol in Set		Buffer All Symbols	
	Beep	T	Beep	T	Beep	T
Last Macro PDF in set	Decode Beep	Y	Decode Beep	Y	Decode Beep	Y
Any Macro PDF in set except last	Decode Beep	Y	Decode Beep	Y	2 Short Low	N
Macro PDF is not in current set	Decode Beep	Y	2 Long Low	N	2 Long Low	N
Invalid formatted Macro PDF	Decode Beep	Y	2 Long Low	N	2 Long Low	N
Macro PDF from a set has already been scanned	Decode Beep	Y	4 Long Low	N	4 Long Low	N
Out of Macro PDF memory	N/A	-	3 Long Low	N	3 Long Low	N
Any non-Macro PDF scanned during a set	N/A	-	4 Long Low	N	4 Long Low	N
Flush Macro PDF	Low Hi	N	5 Long Low	N	5 Long Low	Y
Abort Macro PDF	High Low High Low	N	High Low High Low	N	High Low High Low	N

Notes:

1. The beep only sounds if the *BEEPER_ON signal is connected.
 2. The column marked T indicates whether the symbol is transmitted to the host.
- N = No transmission.**

Macro PDF Transmit / Decode Mode Symbols

Parameter # 188 (SSI # BCh)

Select one of the options below for handling Macro PDF decoding. In *Buffer All Symbols* the imager can handle sets of up to 50 maximum-sized Macro PDF symbols. In all other modes there is no limit to the size of the Macro PDF set.

- **Buffer All Symbols / Transmit Macro PDF When Complete:** This transmits all decode data from an entire Macro PDF sequence only when the entire sequence is scanned and decoded. Use the beeper and LED signals provided with the DS457 when using this mode to ensure proper user feedback. If the decode data exceeds the limit of 50 symbols, there is no transmission because the entire sequence was not scanned. Use the parameter *Flush Macro Buffer on page 12-99* to purge the buffer.
- **Transmit Any Symbol in Set / No Particular Order:** This transmits data from each Macro PDF symbol as decoded, regardless of the sequence (although some error handling is performed; see *Table 12-2*). When selecting this mode, enable *Transmit Macro PDF Control Header on page 12-98*. Also use the beeper and LED signals provided with the DS457 to ensure proper user feedback.
- **Passthrough All Symbols:** This transmits and decodes all Macro PDF symbols and performs no processing. In this mode the host is responsible for detecting and parsing the Macro PDF sequences.

Use this mode when the imager's BEEPER_ON signal is not used to drive a beeper (see *Table 3-1 on page 3-4*). In the other modes, some Macro PDF scanning sequences provide audible feedback only, so if BEEPER_ON is not used no user feedback is provided. In *Table 12-2*, all actions marked **No Transmission** provide no feedback unless the BEEPER_ON signal is used. By using **Passthrough All Symbols** mode every user decode is transmitted to the host where the host software can provide the appropriate feedback.



Buffer All Symbols / Transmit Macro PDF When Complete
(0)



Transmit Any Symbol in Set / No Particular Order
(1)



***Passthrough All Symbols**
(4)

Transmit Macro PDF Control Header

Parameter # 184 (SSI # B8h)

When enabled, this activates transmission of the control header, which contains the segment index and the file ID, in Macro PDF symbols. For example, the field may be: \92800000\725\120\343. The five digits after the \928 are the segment index (or block index), and \725\120\343 is the file ID.

Enable this when selecting *Transmit Any Symbol in Set / No Particular Order* for the [Macro PDF Transmit / Decode Mode Symbols on page 12-97](#), and disable this when selecting *Buffer All Symbols / Transmit Macro PDF When Complete*. This parameter has no effect when *Passthrough All Symbols* is selected.



Enable Macro PDF Control Header Transmit
(1)



*Disable Macro PDF Control Header Transmit
(0)

Escape Characters

Parameter # 233 (SSI # E9h)

This enables the backslash (\) character as an Escape character for systems that can process transmissions containing special data sequences. Scan a bar code below to either format special data according to the GLI (Global Label Identifier) protocol, or to disable this parameter. This parameter only affects the data portion of a Macro PDF symbol transmission; the Macro PDF Control Header (if enabled) is always sent with GLI formatting.



GLI Protocol
(2)



*None
(0)

Flush Macro Buffer

This flushes the buffer of all decoded Macro PDF data stored to that point, transmits it to the host device, and aborts from Macro PDF mode.



Flush Macro PDF Buffer

Abort Macro PDF Entry

This clears all currently-stored Macro PDF data in the buffer without transmission and aborts from Macro PDF mode.



Abort Macro PDF Entry

CHAPTER 13 DRIVER'S LICENSE SET UP (DS457-DL)

Introduction

The DS457-DL imager is capable of parsing out information from standard US driver's licenses and certain other American Association of Motor Vehicle Administrators (AAMVA) compliant ID cards. This is achieved using internally embedded algorithms, where scanning bar codes activates algorithms internally embedded in the imager to produce formatted data. Use the formatted data for age verification, credit card application information, and more.

This chapter describes how to program the DS6708-DL imager to read and use the data contained in the 2D bar codes on US driver's licenses and AAMVA compliant ID cards.

Driver's License Parsing

To enable driver's license parsing on the imager, scan the **Embedded Driver's License Parsing** bar code. The default **No Driver's License Parsing** disables this feature.



***No Driver's License Parsing**

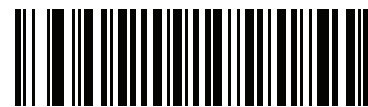

Embedded Driver's License Parsing

Scan the bar codes on the following pages in the order indicating the sequence of data fields that the imager outputs. See [Parsing Driver's License Data Fields \(Embedded Driver's License Parsing\)](#) for more information.

Parsing Driver's License Data Fields (Embedded Driver's License Parsing)

To begin programming a parsing rule:

1. Scan [Begin New Driver's License Parse Rule on page 13-3](#).
2. Scan any of the field bar codes on the following pages, or [Send Keystroke \(Control Characters and Keyboard Characters\) on page 13-23](#) to complete the parsing rule.
3. After entering the entire rule, scan [Save Driver's License Parse Rule on page 13-3](#) to save the rule.

✓ **NOTE** Only ONE driver's license parsing rule may be stored in memory at any time. Saving a new rule replaces the prior rule.

To abort the programming sequence at any time during programming, scan [Quit Entering Driver's License Rule on page 13-3](#). Any previously saved rule is retained.

To erase a programmed saved rule, scan [Erase Driver's License Parse Rules on page 13-3](#).

Embedded Driver's License Parsing Criteria - Code Type

After specifying the fields and their order for the parsed driver's license, you can also apply standard ADF rules to the parsed data using the **Parsed Driver's License** criterion bar code in the *Advanced Data Formatting Programmer Guide*.

✓ **NOTE** Only create standard ADF rules on parsed driver's license data when configured for Embedded Driver's License Parsing.

See [Embedded Driver's License Parsing ADF Example on page 13-20](#) for a sample ADF rule using this code type criterion.

Driver's License Parse Field Bar Codes



Begin New Driver's License Parse Rule

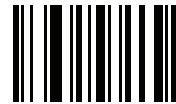

Save Driver's License Parse Rule



Quit Entering Driver's License Rule



Erase Driver's License Parse Rules

Driver's License Parse Field Bar Codes (continued)

The parse fields currently supported begin below. Not all IDs present data in the same format. For example, some IDs may have separate fields for first name, last name, and middle initial, and others may have a single field with the entire name. In addition, some IDs may expire on the subject's birth date and the actual expiration date field may only indicate the year. In order to present data in a consistent format, the following nine bar codes return data that may be calculated from the actual data contained within the ID bar code.

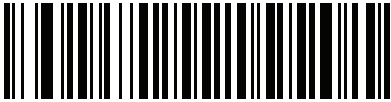

First Name



Middle Name/Initial



Last Name



Name Suffix



Name Prefix



Expiration Date

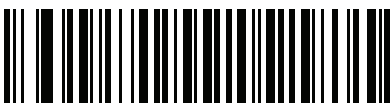

Birth Date

Driver's License Parse Field Bar Codes (continued)



Issue Date

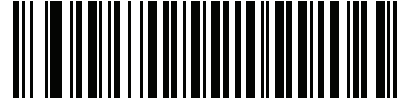

ID Number (Formatted)

AAMVA Parse Field Bar Codes



AAMVA Issuer ID

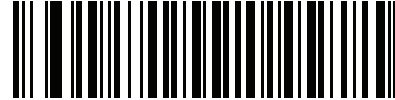

Full Name

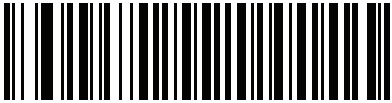

Last Name

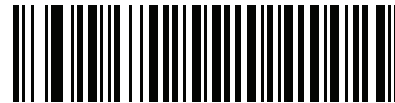

First Name

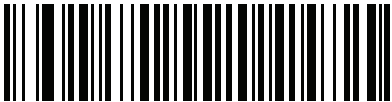

Middle Name / Initial



Name Suffix



Name Prefix

AAMVA Parse Field Bar Codes (continued)

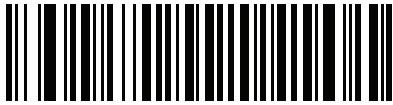

Mailing Address Line 1



Mailing Address Line 2

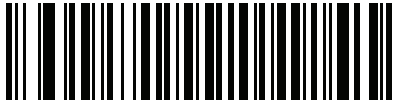

Mailing Address City

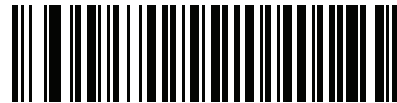

Mailing Address State

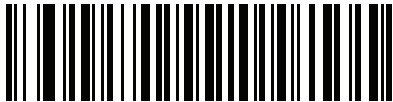

Mailing Address Postal Code



Home Address Line 1



Home Address Line 2

AAMVA Parse Field Bar Codes (continued)



Home Address City

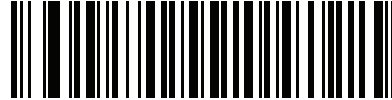

Home Address State

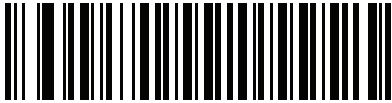

Home Address Postal Code

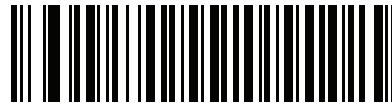

License ID Number

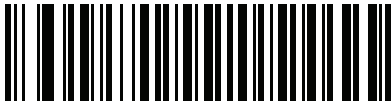

License Class



License Restrictions



License Endorsements

AAMVA Parse Field Bar Codes (continued)



Height (Feet and/or Inches)

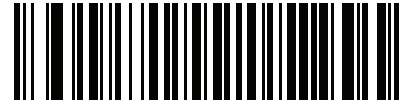

Height (Centimeters)

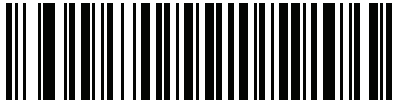

Weight (Pounds)

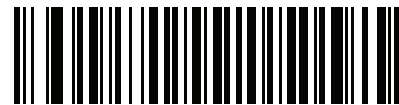

Weight (Kilograms)

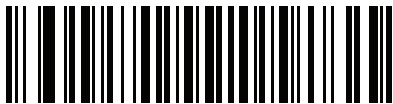

Eye Color



Hair Color



License Expiration Date

AAMVA Parse Field Bar Codes (continued)

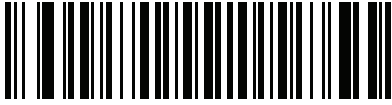

Birth Date

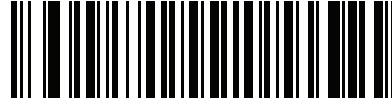

Gender



License Issue Date

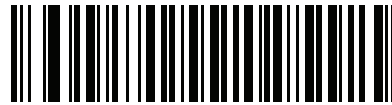

Social Security Number

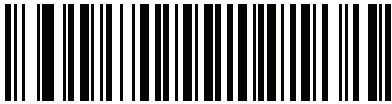

Permit Class

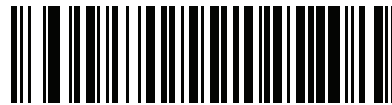

Permit Expiration Date



Permit ID Number

AAMVA Parse Field Bar Codes (continued)

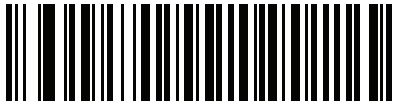

Permit Issue Date

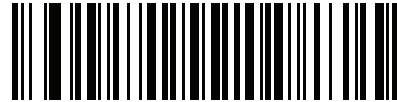

Permit Restrictions

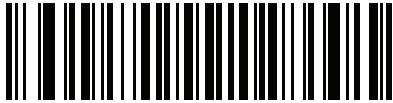

Permit Endorsements

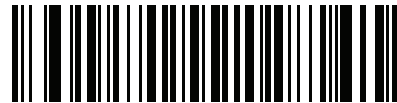

AKA Social Security Name

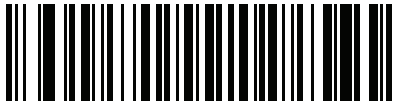

AKA Full Name



AKA Last Name

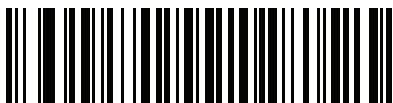

AKA First Name

AAMVA Parse Field Bar Codes (continued)



AKA Middle Name / Initial

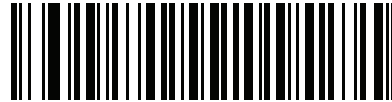

AKA Name Suffix

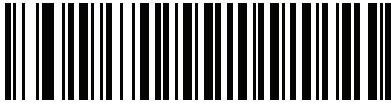

AKA Name Prefix

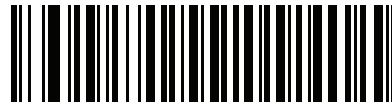

AKA Birth Date

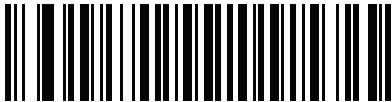

Issue Timestamp

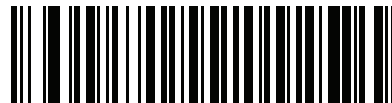

Number of Duplicates



Medical Codes

AAMVA Parse Field Bar Codes (continued)

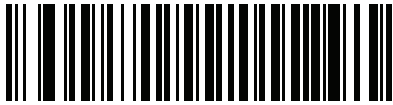

Organ Donor

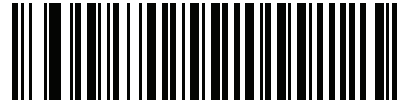

Nonresident

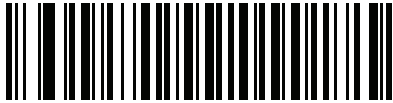

Customer ID

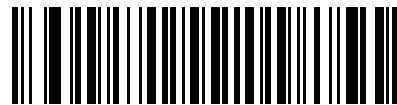

Weight Range

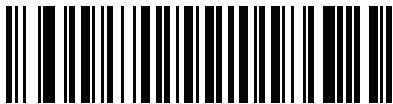

Document Discriminator



Country

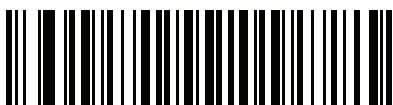

Federal Commission Codes

AAMVA Parse Field Bar Codes (continued)



Place of Birth

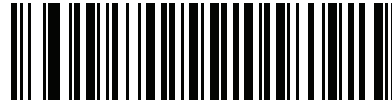

Audit Information

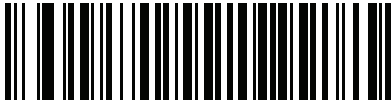

Inventory Control

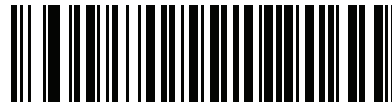

Race / Ethnicity

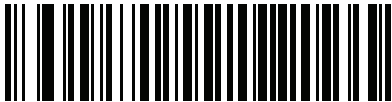

Std Vehicle Class

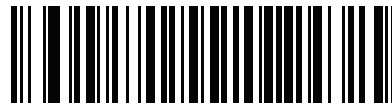

Std Endorsements



Std Restrictions

AAMVA Parse Field Bar Codes (continued)

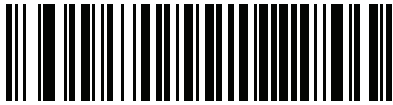

Class Description



Endorsement Description

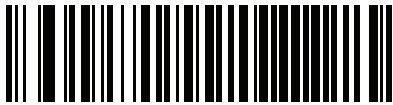

Restrictions Description



Height in Inches

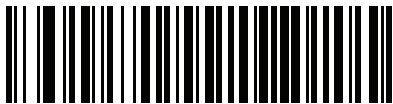

Height in Centimeters

Parser Version ID Bar Codes

Include this field to emit embedded parser software version identification



Parser Version ID

Parsing Rule Example

Scan the following bar codes in sequence to program the imager to extract and transmit first, middle, and last names; mailing address line 1; mailing address line 2; mailing address city; mailing address state; mailing address postal code; and, date of birth. Then, scan a driver's license bar code.

✓ **NOTE** This example applies to RS-232. To use this example with a USB interface, scan [Function Key Mapping on page 10-11](#) in place of the **Send Control M (Carriage Return)** bar codes.

1



Embedded Driver's License Parsing

2



Begin New Driver's License Parse Rule

3



First Name

4



Send Space

5

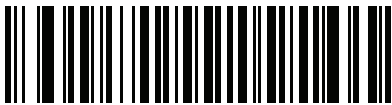

Middle Name / Initial

6



Send Space

Parsing Rule Example (continued)

7



Last Name

8



Send Enter Key

9



Mailing Address Line 1

10



Send Space

11



Mailing Address Line 2

q

12



Send Enter Key

Parsing Rule Example (continued)

13

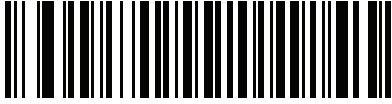

Mailing Address City

14



Send Space

15

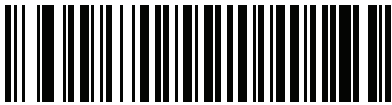

Mailing Address State

16



Send Space

17

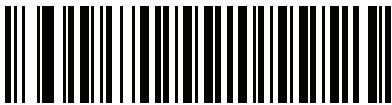

Mailing Address Postal Code

Parsing Rule Example (continued)

18



Send Enter Key

19

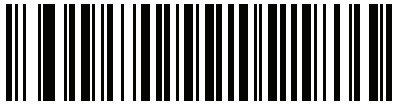

Birth Date

20



Send Enter Key

21



Save Driver's Licence Parse Rule

Embedded Driver's License Parsing ADF Example

This example creates a parsing rule for parsed data configured to result in the format:

Last Name, First Name

1

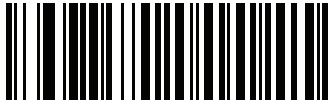

Begin New Driver's License Parse Rule

2

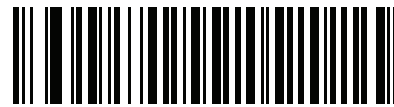

Last Name

3



Send ,

4



Send Space

5



First Name

6



Save Driver's Licence Parse Rule

Then, in order to limit the full name to 15 characters, create the following ADF rule:

1



Begin New Rule

2



Criterion: Parsed Driver's License

3



Action: Send Next 15 Characters

4



Save Rule

For a license belonging to Michael Williams, the parsed data is Williams, Michael and Williams, Micha after applying the previous ADF rule.

Field Update Procedure

Scan the following bar codes in order to perform a field update.

This update COMPLETELY REPLACES prior updates and overrides any embedded parsing software programmed in the imager.

1. Scan **Field Update Start**.



Field Update Start

2. Scan the entire set of PDF bar codes provided separately.

3. Scan **Field Update End**.



Field Update End

Scan **Erase all Field Updates** to completely remove all previous updates. It is not necessary to scan this bar code before performing a normal field update. Scanning this bar code ensures that only the parsing software currently in the imager is used for parsing.



Erase all Field Updates

User Preferences

Set Default Parameter

Scan this bar code to return all parameters to the default values listed in [Table A-1 on page A-1](#).



***Set All Defaults**

Send Keystroke (Control Characters and Keyboard Characters)

Control Characters

Scan a **Send** bar code for the keystroke to send.



Send Control A



Send Control B

Control Characters (continued)



Send Control C



Send Control D



Send Control E



Send Control F



Send Control G



Send Control H



Send Control I

Control Characters (continued)



Send Control J



Send Control K



Send Control L



Send Control M



Send Control N



Send Control O



Send Control P

Control Characters (continued)



Send Control Q



Send Control R



Send Control S



Send Control T



Send Control U



Send Control V



Send Control W

Control Characters (continued)



Send Control X



Send Control Y



Send Control Z



Send Control [



**Send Control **



Send Control]

Control Characters (continued)



Send Control 6



Send Control -

Keyboard Characters

Scan a **Send** bar code for the keyboard characters to send.



Send Space



Send !



Keyboard Characters (continued)



Send \$



Send %



Send &



Send '



Send (



Send)



Send *

Keyboard Characters (continued)



Send +



Send ,



Send -



Send .



Send /



Send 0



Send 1

Keyboard Characters (continued)



Send 2



Send 3



Send 4



Send 5



Send 6



Send 7



Send 8

Keyboard Characters (continued)



Send 9



Send :



Send ;



Send <



Send =



Send >



Send ?

Keyboard Characters (continued)



Send @



Send A



Send B



Send C



Send D



Send E



Send F

Keyboard Characters (continued)



Send G



Send H



Send I



Send J



Send K



Send L



Send M

Keyboard Characters (continued)



Send N



Send O



Send P



Send Q



Send R



Send S



Send T

Keyboard Characters (continued)



Send U



Send V



Send W



Send X



Send Y



Send Z

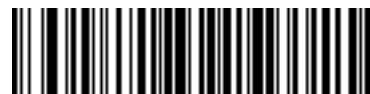

Send [

Keyboard Characters (continued)



Send \



Send]



Send ^



Send _



Send `



Send a



Send b

Keyboard Characters (continued)



Send c



Send d



Send e



Send f



Send g



Send h



Send i

Keyboard Characters (continued)



Send j



Send k



Send l



Send m



Send n



Send o



Send p

Keyboard Characters (continued)



Send q



Send r



Send s



Send t



Send u



Send v



Send w

Keyboard Characters (continued)



Send x



Send y



Send z



Send {



Send |



Send }



Send ~

Keyboard Characters (continued)



Send Tab Key



Send Enter Key

CHAPTER 14 123SCAN

Introduction

123Scan is an easy to use, PC-based software tool that enables rapid customized setup of Zebra imagers.

123Scan uses a wizard tool to guide users through a streamlined set up process. Settings are saved in a configuration file that can be distributed via e-mail, electronically downloaded via a USB cable, or used to generate a sheet of scannable programming bar codes.

Additionally 123Scan can upgrade imager firmware, check online to enable support for newly released products, generate a collection of multi-setting bar codes if the number of settings is very large, stage a large number of imagers simultaneously, generate reports with asset tracking information, and create custom products.

123Scan is an easy-to-use, PC-based software tool that enables the quick and easy setup of Zebra imagers. 123Scan uses a wizard tool to guide users through a streamlined set up process. Once parameters are set, the values are saved to a configuration file that can be distributed via e-mail, or used to generate a sheet of programming bar codes that can be scanned.

Communication with 123Scan

To communicate with the 123Scan program which runs on a host computer running a Windows XP SP2 or Windows 7 operating system, use a USB cable to connect the imager to the host computer (see [USB Host Connection on page 2-8](#)).

123Scan Requirements

- Host computer with Windows XP SP2 or Windows 7
- Imager
- USB cable.

For more information on 123Scan, go to: <http://www.zebra.com/123Scan>

For a 1 minute tour of 123Scan, go to: <http://www.zebra.com/ScannerHowToVideos>

To see a list of all of our software tools, go to: <http://www.zebra.com/scannersoftware>

Scanner SDK, Other Software Tools, and Videos

Tackle all your scanner programming needs with our diversified set of software tools. Whether you need to simply stage a device, or develop a fully featured application with image and data capture as well as asset management, these tools help you every step of the way. To download any of the free tools listed below, go to: <http://www.zebra.com/scannersoftware>.

- 123Scan configuration utility (described in this chapter)
- Scanner SDK for Windows
- How-to videos
- Virtual COM port driver
- OPOS driver
- JPOS driver
- Scanner user documentation
- Archive of older drivers.

CHAPTER 15 ADVANCED DATA FORMATTING

Introduction

Advanced Data Formatting (ADF) is a means of customizing data before transmission to the host device. Use ADF to edit scan data to suit requirements. Implement ADF by scanning a related series of bar codes which program the imager with ADF rules.

For information and programming bar codes for ADF, refer to the *Advanced Data Formatting Programmer Guide*, p/n 72E-69680-xx.

APPENDIX A STANDARD DEFAULT PARAMETERS

Default Parameters

Table A-1 Standard Default Parameters Table

Parameter	Parameter Number	SSI Number	Default	Page Number
User Preferences				
Set Default Parameter	N/A	N/A	Restore Defaults	6-5
Parameter Scanning	236	ECh	Enable	6-6
User Parameter Pass Through	625	F1h 71h	Disable	6-7
Beep After Good Decode	56	38h	Enable	6-8
Beeper Tone	145	91h	Medium	6-9
Beeper Volume	140	8Ch	High	6-10
Suppress Power-up Beeps	721	F1h D1h	Do not suppress	6-10
Trigger Modes	138	8Ah	Presentation	6-11
Presentation Performance Mode	650	F1h 8Ah	Standard	6-12
Time Delay to Presentation Idle Mode	663	F1h 97h	1 Minute	6-13
Time Delay to Presentation Sleep Mode	662	F1h 96h	1 Minute	6-15
Power Mode	128	80h	Low Power	6-17
Time Delay to Low Power Mode	146	92h	1.0 Sec	6-17
Picklist Mode	402	F0h 92h	Disabled Always	6-19
Decode Session Timeout	136	88h	9.9 Sec	6-19

¹User selection is required to configure this interface and this is the most common selection.

Table A-1 Standard Default Parameters Table (Continued)

Parameter	Parameter Number	SSI Number	Default	Page Number
Timeout Between Decodes, Same Symbol	137	89h	0.6 Sec	6-20
Continuous Bar Code Read	649	F1 89h	Disable	6-20
Unique Bar Code Reporting	723	F1h D3h	Enable	6-21
Mirrored Image	624	F1h 70h	Disable	6-21
Mobile Phone/Display Mode	716	F1h CCh	Disable	6-22
Validate Concatenated Parameter Bar Codes	692	F1h B4h	Disable	6-22
PDF Prioritization	719	F1h CFh	Disable	6-23
PDF Prioritization Timeout	720	F1h D0h	400 ms	6-23
Multicode Mode	677	F1h A5h	Disable	6-24
Multicode Expression	661	F1h 95h	1	6-25
Multicode Mode Concatenation	717	F1h, CDh	Disable	6-33
Multicode Concatenation Symbology	722	F1h, D2h	Concatenate as PDF417	6-34
Miscellaneous Parameters				
Transmit Code ID Character	45	2Dh	None	6-37
SSI Prefix Value	105	69h	<CR>	6-38
SSI Suffix 1 Value	104	68h	<CR>	6-38
SSI Suffix 2 Value	106	6Ah	<CR>	
Non-SSI Prefix Value	99, 105	63h, 69h	<CR><LF>	6-38
Non-SSI Suffix 1 Value	98, 104	62h, 68h	<CR><LF>	6-38
Non-SSI Suffix 2 Value	100, 106	64h, 6Ah	<CR><LF>	
Scan Data Transmission Format	235	EBh	Data as is	6-39
FN1 Substitution Values	103, 109	67h, 6Dh	Set	6-40
Transmit "No Read" Message	94	5Eh	Disable	6-41
Report Version				6-41

¹User selection is required to configure this interface and this is the most common selection.

Table A-1 Standard Default Parameters Table (Continued)

Parameter	Parameter Number	SSI Number	Default	Page Number
Imager Preferences				
Decoding Autoexposure	297	F0h 29h	Enable	7-5
Decoding Illumination	298	F0h 2Ah	Enable	7-6
Decode Aiming Pattern	306	F0h 32h	Enable	7-6
Aim Brightness	668	F1h 9Ch	0	7-7
Illumination Brightness	669	F1h 9Dh	10	7-7
Low Light Enhancement	612	F1h 64h	Disable	7-8
Power Up Light in Presentation Mode	1198	F8h 04h AEh	Disable	7-8
Presentation Mode Field of View	609	F1h 61h	Default (Reduced)	7-9
Frame Rate	674	F1h A2h	Auto	7-10
Image Capture Autoexposure	360	F0h 68h	Enable	7-12
Image Capture Illumination	361	F0h 69h	Enable	7-12
Fixed Gain	568	F1h 38h	50	7-13
Exposure Time	567	F4h F1h 37h	100 (10 ms)	7-13
Snapshot Mode Timeout	323	F0h 43h	0 (30 seconds)	7-14
Snapshot Aiming Pattern	300	F0h 2Ch	Enable	7-14
Presentation Snapshot by Motion	647	F1h 87h	Disable	7-15
Continuous Snapshot	648	F1h 88h	Disable	7-15
Image Cropping	301	F0h 2Dh	Disable	7-16
Crop to Pixel Addresses	315, 316, 317, 318	F4h F0h 3Bh; F4h F0h 3Ch; F4h F0h 3Dh; F4h F0h 3Eh	0 top, 0 left, 479 bottom, 751 right	7-17
Image Resolution	302	F0h 2Eh	Full	7-18
Image Brightness (Target White)	390	F0h 86h	180	7-19
Image File Format Selection	304	F0h 30h	JPEG	7-20
JPEG Image Options	299	F0h 2Bh	Quality	7-20
JPEG Quality Value	305	F0h 31h	65	7-21
JPEG Size Value	561	F1h 31h	160 (164K)	7-21
Image File Meta Data	693	F1h B5h	Disable	7-22
Image Enhancement	564	F1h 34h	Off	7-23

¹User selection is required to configure this interface and this is the most common selection.

Table A-1 Standard Default Parameters Table (Continued)

Parameter	Parameter Number	SSI Number	Default	Page Number
Image Edge Sharpening	664	F1h 98h	Low	7-24
Image Contrast Enhancement	666	F1h 9Ah	Off	7-25
Image Rotation	665	F1h 99h	0	7-26
Bits per Pixel (BPP)	303	F0h 2Fh	8 BPP	7-27
Signature Capture	93	5Dh	Disable	7-28
Signature Capture Image File Format Selection	313	F0h 39h	JPEG	7-29
Signature Capture Bits per Pixel (BPP)	314	F0h 3Ah	8 BPP	7-30
Signature Capture Width	366	F4h F0h 6Eh	400	7-30
Signature Capture Height	367	F4h F0h 6Fh	100	7-31
Signature Capture JPEG Quality	421	F0h A5h	65	7-31
Video Mode Format Selector	916	F2h 94h	JPEG	7-32
Video View Finder	324	F0h 44h	Disable	7-32
Target Video Frame Size	328	F0h 48h	2200 bytes	7-33
Video View Finder Image Size	329	F0h 49h	1700 bytes	7-33
Video Resolution	667	F1h 9Bh	1/4 resolution	7-34
SSI Host Parameters				
Select SSI Host	N/A	N/A	N/A	8-9
Baud Rate	156	9Ch	9600	8-10
Parity	258	9Eh	None	8-11
Check Parity	151	97h	Disable	8-12
Software Handshaking	159	9Fh	ACK/NAK	8-12
Host RTS Line State	154	9Ah	Low	8-13
Decode Data Packet Format	238	EEh	Send Raw Decode Data	8-13
Host Serial Response Time-out	155	9Bh	2 sec	8-14
Host Character Time-out	239	EFh	200 msec	8-15
Multipacket Option	334	F0h 4Eh	Option 1	8-16
Interpacket Delay	335	F0h 4Fh	0 ms	8-17

¹User selection is required to configure this interface and this is the most common selection.

Table A-1 Standard Default Parameters Table (Continued)

Parameter	Parameter Number	SSI Number	Default	Page Number
Event Reporting				
Decode Event	256	F0h 00h	Disable	8-18
Boot Up Event	258	F0h 02h	Disable	8-19
Parameter Event	259	F0h 03h	Disable	8-19
Serial Host Parameters				
Serial Host Types	N/A	N/A	Standard RS-232	9-5
Baud Rate	N/A	N/A	9600	9-7
Parity Type	N/A	N/A	None	9-9
Data Bits	N/A	N/A	8-Bit	9-9
Check Receive Errors	N/A	N/A	Enable	9-10
Hardware Handshaking	N/A	N/A	None	9-11
Software Handshaking	N/A	N/A	None	9-13
Host Serial Response Time-out	N/A	N/A	2 Sec	9-15
RTS Line State	N/A	N/A	Low RTS	9-16
Beep on <BEL>	N/A	N/A	Disable	9-16
Intercharacter Delay	N/A	N/A	0 msec	9-17
Nixdorf Beep/LED Options	N/A	N/A	Normal Operation	9-18
Ignore Unknown Characters	N/A	N/A	Send Bar Code	9-18
USB Host Parameters				
USB Device Type	N/A	N/A	USB HID Keyboard	10-3
Symbol Native API (SNAPI) Status Handshaking	N/A	N/A	Enable	10-5
USB Country Keyboard Types (Country Codes)	N/A	N/A	North American	10-6
USB Keystroke Delay	N/A	N/A	No Delay	10-8
USB CAPS Lock Override	N/A	N/A	Disable	10-8
USB Ignore Unknown Characters	N/A	N/A	Enable	10-9
Emulate Keypad	N/A	N/A	Disable	10-9
Emulate Keypad with Leading Zero	N/A	N/A	Disable	10-10
Quick Keypad Emulation	N/A	N/A	Disable	10-10

¹User selection is required to configure this interface and this is the most common selection.

Table A-1 Standard Default Parameters Table (Continued)

Parameter	Parameter Number	SSI Number	Default	Page Number
USB FN1 Substitution	N/A	N/A	Disable	10-11
Function Key Mapping	N/A	N/A	Disable	10-11
Simulated Caps Lock	N/A	N/A	Disable	10-12
Convert Case	N/A	N/A	None	10-13
USB Static CDC	N/A	N/A	Enable	10-13
USB Ignore Beep Directive	N/A	N/A	Honor	10-14
USB Ignore Type Directive	N/A	N/A	Honor	10-14
USB Polling Interval	N/A	N/A	3 msec	10-15
Fast HID Keyboard	N/A	N/A	Enable	10-17
IBM Specification Level	N/A	N/A	Version 0 (Original)	10-17
OCR Programming Parameters				
OCR-A	680	F1h A8h	Disable	11-3
OCR-A Variant	684	F1h ACh	Full ASCII	11-3
OCR-B	681	F1h A9h	Disable	11-5
OCR-B Variant	685	F1h ADh	Full ASCII	11-6
MICR E13B	682	F1h AAh	Disable	11-9
US Currency	683	F1h ABh	Disable	11-10
OCR Orientation	687	F1h AFh	0°	11-10
OCR Lines	691	F1h B3h	1	11-12
OCR Min Char	689	F1h B1h	3	11-13
OCR Max Char	690	F1h B2h	100	11-13
OCR Security Level	554	F1h 2Ah	80	11-13
OCR Subset	686	F1h AEh	Selected font variant	11-14
OCR Quiet Zone	695	F1h B7h	50	11-14
OCR Bright Illumination	701	F1h BDh	Disable	11-15
OCR Template	547	F1h 23h	54R	11-16
OCR Check Digit Modulus	688	F1h B0h	1	11-25
OCR Check Digit Multiplier	700	F1h BCh	121212121212	11-26
OCR Check Digit Validation	694	F1h B6h	None	11-27

¹User selection is required to configure this interface and this is the most common selection.

Table A-1 Standard Default Parameters Table (Continued)

Parameter	Parameter Number	SSI Number	Default	Page Number
Inverse OCR	856	F2h 58h	None	11-31
Disable All Symbologies	N/A	N/A	N/A	12-8
UPC/EAN				
UPC-A	1	01h	Enable	12-9
UPC-E	2	02h	Enable	12-9
UPC-E1	12	0Ch	Disable	12-10
EAN-8/JAN 8	4	04h	Enable	12-10
EAN-13/JAN 13	3	03h	Enable	12-11
Bookland EAN	83	53h	Disable	12-11
Decode UPC/EAN/JAN Supplementals (2 and 5 digits)	16	10h	Ignore	12-12
User-Programmable Supplementals				12-15
Supplemental 1:	579	F1h 43h		
Supplemental 2:	580	F1h 44h		
UPC/EAN/JAN Supplemental Redundancy	80	50h	10	12-15
UPC/EAN/JAN Supplemental AIM ID Format	672	F1h A0h	Combined	12-16
Transmit UPC-A Check Digit	40	28h	Enable	12-17
Transmit UPC-E Check Digit	41	29h	Enable	12-17
Transmit UPC-E1 Check Digit	42	2Ah	Enable	12-18
UPC-A Preamble	34	22h	System Character	12-19
UPC-E Preamble	35	23h	System Character	12-20
UPC-E1 Preamble	36	24h	System Character	12-21
Convert UPC-E to A	37	25h	Disable	12-22
Convert UPC-E1 to A	38	26h	Disable	12-22
EAN-8/JAN-8 Extend	39	27h	Disable	12-23
Bookland ISBN Format	576	F1h 40h	ISBN-10	12-24
UCC Coupon Extended Code	85	55h	Disable	12-25
Coupon Report	730	F1h DAh	New Coupon Format	12-26
ISSN EAN	617	F1h 69h	Disable	12-27

¹User selection is required to configure this interface and this is the most common selection.

Table A-1 Standard Default Parameters Table (Continued)

Parameter	Parameter Number	SSI Number	Default	Page Number
Code 128				
Code 128	8	08h	Enable	12-28
Set Length(s) for Code 128	209, 210	D1h D2h	Any Length	12-28
GS1-128 (UCC/EAN-128)	14	0Eh	Enable	12-30
ISBT 128	84	54h	Enable	12-30
ISBT Concatenation	577	F1h 41h	Disable	12-31
Check ISBT Table	578	F1h 42h	Enable	12-32
ISBT Concatenation Redundancy	223	DFh	10	12-32
Code 128 Security Level	751	F3h EFh	Security Level 1	12-33
Code 39				
Code 39	0	00h	Enable	12-34
Trioptic Code 39	13	0Dh	Disable	12-34
Convert Code 39 to Code 32 (Italian Pharmacy Code)	86	56h	Disable	12-35
Code 32 Prefix	231	E7h	Disable	12-35
Set Length(s) for Code 39	18, 19	12h 13h	2 to 55	12-36
Code 39 Check Digit Verification	48	30h	Disable	12-37
Transmit Code 39 Check Digit	43	2Bh	Disable	12-38
Code 39 Full ASCII Conversion	17	11h	Disable	12-38
Buffer Code 39	113	71h	Disable	12-39
Code 39 Security Level	750	F3h EEh	Security Level 1	12-42
Code 93				
Code 93	9	09h	Disable	12-43
Set Length(s) for Code 93	26, 27	1Ah 1Bh	4 to 55	12-43
Code 11				
Code 11	10	0Ah	Disable	12-45
Set Lengths for Code 11	28, 29	1Ch 1Dh	4 to 55	12-45
Code 11 Check Digit Verification	52	34h	Disable	12-47
Transmit Code 11 Check Digit(s)	47	2Fh	Disable	12-48

¹User selection is required to configure this interface and this is the most common selection.

Table A-1 Standard Default Parameters Table (Continued)

Parameter	Parameter Number	SSI Number	Default	Page Number
Interleaved 2 of 5 (ITF)				
Interleaved 2 of 5 (ITF)	6	06h	Enable	12-48
Set Lengths for I 2 of 5	22, 23	16h 17h	Range 6 - 55	12-49
I 2 of 5 Check Digit Verification	49	31h	Disable	12-50
Transmit I 2 of 5 Check Digit	44	2Ch	Disable	12-51
Convert I 2 of 5 to EAN 13	82	52h	Disable	12-51
I 2 of 5 Security Level	1121		Security Level 1	12-52
Discrete 2 of 5 (DTF)				
Discrete 2 of 5	5	05h	Disable	12-53
Set Length(s) for D 2 of 5	20, 21	14h 15h	12	12-53
Codabar (NW - 7)				
Codabar	7	07h	Disable	12-55
Set Lengths for Codabar	24, 25	18h 19h	5 to 55	12-55
CLSI Editing	54	36h	Disable	12-57
NOTIS Editing	55	37h	Disable	12-57
Codabar Upper or Lower Case Start/Stop Characters Transmission	855	F2h 57h	Upper Case	12-58
MSI				
MSI	11	0Bh	Disable	12-59
Set Length(s) for MSI	30, 31	1Eh 1Fh	4 to 55	12-59
MSI Check Digits	50	32h	One	12-61
Transmit MSI Check Digit	46	2Eh	Disable	12-62
MSI Check Digit Algorithm	51	33h	Mod 10/Mod 10	12-62
Chinese 2 of 5				
Chinese 2 of 5	408	F0h 98h	Disable	12-63
Matrix 2 of 5				
Matrix 2 of 5	618	F1h 6Ah	Disable	12-63
Matrix 2 of 5 Lengths	619, 620	F1h 6Bh F1h 6Ch	1 Length: 14	12-64
Matrix 2 of 5 Check Digit	622	F1h 6Eh	Disable	12-65

¹User selection is required to configure this interface and this is the most common selection.

Table A-1 Standard Default Parameters Table (Continued)

Parameter	Parameter Number	SSI Number	Default	Page Number
Transmit Matrix 2 of 5 Check Digit	623	F1h 6Fh	Disable	12-65
Korean 3 of 5				
Korean 3 of 5	581	F1h 45h	Disable	12-66
Inverse 1D	586	F1h 4Ah	DS457-SR/HD/DL: Regular DS457-DP: Inverse Autodetect	12-67
Postal Codes				
US Postnet	89	59h	Disable	12-68
US Planet	90	5Ah	Disable	12-68
Transmit US Postal Check Digit	95	5Fh	Enable	12-69
UK Postal	91	5Bh	Disable	12-69
Transmit UK Postal Check Digit	96	60h	Enable	12-70
Japan Postal	290	F0h 22h	Disable	12-70
Australia Post	291	F0h 23h	Disable	12-71
Australia Post Format	718	F1h CEh	Autodiscriminate	12-72
Netherlands KIX Code	326	F0h 46h	Disable	12-73
USPS 4CB/One Code/Intelligent Mail	592	F1h 50h	Disable	12-74
UPU FICS Postal	611	F1h 63h	Disable	12-74
GS1 DataBar (formerly RSS, Reduced Space Symbology)				
GS1 DataBar (GS1 DataBar Omnidirectional, GS1 DataBar Truncated, GS1 DataBar Stacked, GS1 DataBar Stacked Omnidirectional)	338	F0h 52h	Enable	12-75
GS1 DataBar Limited	339	F0h 53h	Enable	12-76
GS1 DataBar Limited Security Level	728	F1h D8h	3	12-77
GS1 DataBar Expanded (GS1 DataBar Expanded, GS1 DataBar Expanded Stacked)	340	F0h 54h	Enable	12-78
Convert GS1 DataBar to UPC/EAN	397	F0h 8Dh	Disable	12-78
Composite				
Composite CC-C	341	F0h 55h	Disable	12-79
Composite CC-A/B	342	F0h 56h	Disable	12-79

¹User selection is required to configure this interface and this is the most common selection.

Table A-1 Standard Default Parameters Table (Continued)

Parameter	Parameter Number	SSI Number	Default	Page Number
Composite TLC-39	371	F0h 73h	Disable	12-80
UPC Composite Mode	344	F0h 58h	Never Linked	12-81
Composite Beep Mode	398	F0h 8Eh	Beep As Each Code Type is Decoded	12-82
GS1-128 Emulation Mode for UCC/EAN Composite Codes	427	F0h ABh	Disable	12-82
2D Symbologies				
PDF417	15	0Fh	Enable	12-83
MicroPDF417	227	E3h	Disable	12-83
Code 128 Emulation	123	7Bh	Disable	12-84
Data Matrix	292	F0h 24h	Enable	12-85
Data Matrix Inverse	588	F1h 4Ch	DS457-SR/HD/DL: Regular DS457-DP: Inverse Autodetect	12-86
Decode Mirror Images (Data Matrix Only)	537	F1h, 19h	Auto	12-87
Maxicode	294	F0h 26h	Disable	12-88
QR Code	293	F0h 25h	Enable	12-88
QR Inverse	587	F1h 4Bh	Regular	12-89
MicroQR	573	F1h 3Dh	Enable	12-90
Aztec	574	F1h 3Eh	Enable	12-90
Aztec Inverse	589	F1h 4Dh	Inverse Autodetect	12-91
Symbology-Specific Security Levels				
Redundancy Level	78	4Eh	1	12-92
Security Level	77	4Dh	1	12-94
Intercharacter Gap Size	381	F0h 7Dh	Normal	12-95

¹User selection is required to configure this interface and this is the most common selection.

Table A-1 Standard Default Parameters Table (Continued)

Parameter	Parameter Number	SSI Number	Default	Page Number
Macro PDF				
Macro PDF Transmit/Decode Mode Symbols	188	BCh	Passthrough Mode	12-97
Transmit Macro PDF Control Header	184	B8h	Disable	12-98
Escape Characters	233	E9h	None	12-98
Flush Macro PDF Buffer	N/A	N/A	N/A	12-99
Abort Macro PDF Entry	N/A	N/A	N/A	12-99

¹User selection is required to configure this interface and this is the most common selection.

Reserved Parameters

The DS457 reports the following parameters, however these parameters are reserved for future use.

- 0x20
- 0x21
- 0x3A
- 0x3B
- 0x3C
- 0x3D
- 0x3E
- 0x3F
- 0x40
- 0x41
- 0x42
- 0x45
- 0x71
- 0xCF
- 0xD0
- 0xD1
- 0xD2
- 0xD5
- 0xEA
- 0xF0, 0x01
- 0xF0, 0x04
- 0xF0, 0x05
- 0xF0, 0x28
- 0xF0, 0x94
- 0xF0, 0x96
- 0xF0, 0x97
- 0xF0, 0x98
- 0xF0, 0x99
- 0xF0, 0xA8
- 0xF0, 0xA9

APPENDIX B PROGRAMMING REFERENCE

Code Identifiers

AIM Code Identifiers

Each AIM Code Identifier contains the three-character string]cm where:

-] = Flag Character (ASCII 93)
- c = Code Character (see [Table B-1](#))
- m = Modifier Character (see [Table B-2](#))

The modifier character is the sum of the applicable option values based on [Table B-2](#).

Table B-1 Code Characters

Code Type	Symbol Code Character	AIM Code Character
UPC-A, UPC-E, UPC-E1, EAN-8, EAN-13	A	E
Code 39, Code 32	B	A
Codabar	C	F
Code 128, ISBT 128	D	C
Code 93	E	G
Interleaved 2 of 5	F	I
Discrete 2 of 5, or Discrete 2 of 5 IATA	G	S
Code 11	H	H
MSI	J	M
GS1-128	K	
Bookland EAN	L	X
Trioptic Code 39	M	X

Table B-1 Code Characters (Continued)

Code Type	Symbol Code Character	AIM Code Character
Coupon Code	N	E (UPC portion) C (Code 128 portion)
GS1 DataBar Family	R	e
Matrix 2 of 5	S	X
UCC Composite, TLC 39	T	
Chinese 2 of 5	U	X
Korean 3 of 5	V	X
ISSN	X	X
PDF417, Macro PDF417, Micro PDF417	X	L
Aztec, Aztec Rune	z	z
Data Matrix	P00	d
QR Code, MicroQR	P01	Q
Maxicode	P02	U
US Postnet	P03	X
US Planet	P04	X
Japan Postal	P05	X
UK Postal	P06	X
Netherlands KIX Code	P08	X
Australia Post	P09	X
USPS 4CB/One Code/Intelligent Mail	P0A	X
UPU FICS Postal	P0B	X

Table B-2 AIM Code Modifier Characters

Code Type	Option Value	Option
Code 39	0	No check character or Full ASCII processing.
	1	Reader has checked one check character.
	3	Reader has checked and stripped check character.
	4	Reader has performed Full ASCII character conversion.
	5	Reader has performed Full ASCII character conversion and checked one check character.
	7	Reader has performed Full ASCII character conversion and checked and stripped check character.
	Example: A Full ASCII bar code with check character W, A+I+MI+DW , is transmitted as J A7AIMID where 7 = (3+4).	
Trioptic Code 39	0	No option specified at this time. Always transmit 0.
	Example: A Trioptic bar code 412356 is transmitted as J X0412356	
Code 128	0	Standard data packet, no Function code 1 in first symbol position.
	1	Function code 1 in first symbol character position.
	2	Function code 1 in second symbol character position.
	Example: A Code (EAN) 128 bar code with Function 1 character ^{FNC1} in the first position, AIMID is transmitted as J C1AIMID	
I 2 of 5	0	No check digit processing.
	1	Reader has validated check digit.
	3	Reader has validated and stripped check digit.
	Example: An I 2 of 5 bar code without check digit, 4123, is transmitted as J I04123	
Codabar	0	No check digit processing.
	1	Reader has checked check digit.
	3	Reader has stripped check digit before transmission.
	Example: A Codabar bar code without check digit, 4123, is transmitted as J F04123	
Code 93	0	No options specified at this time. Always transmit 0.
	Example: A Code 93 bar code 012345678905 is transmitted as J G0012345678905	
MSI	0	Check digits are sent.
	1	No check digit is sent.
	Example: An MSI bar code 4123, with a single check digit checked, is transmitted as J M14123	

Table B-2 AIM Code Modifier Characters (Continued)

Code Type	Option Value	Option
D 2 of 5	0	No options specified at this time. Always transmit 0.
		Example: A D 2 of 5 bar code 4123, is transmitted as JS04123
UPC/EAN	0	Standard packet in full EAN country code format, which is 13 digits for UPC-A, UPC-E, and EAN-13 (not including supplemental data).
	1	Two-digit supplement data only.
	2	Five-digit supplement data only.
	3	Combined data packet comprising 13 digits from a UPC-A, UPC-E, or EAN-13 symbol and 2 or 5 digits from a supplemental symbol.
	4	EAN-8 data packet.
		Example: A UPC-A bar code 012345678905 is transmitted as JE00012345678905
Bookland EAN	0	No options specified at this time. Always transmit 0.
		Example: A Bookland EAN bar code 123456789X is transmitted as JX0123456789X
Code 11	0	Single check digit
	1	Two check digits
	3	Check characters validated but not transmitted.
GS1 DataBar Family		No option specified at this time. Always transmit 0. GS1 DataBar Omnidirectional and GS1 DataBar Limited transmit with an Application Identifier "01". Note: In GS1-128 emulation mode, GS1 DataBar is transmitted using Code 128 rules (i.e., JC1).
		Example: A GS1 DataBar Omnidirectional bar code 100123456788902 is transmitted as Je001100123456788902 .
EAN.UCC Composites (GS1 DataBar, GS1-128, 2D portion of UPC composite)		Native mode transmission. Note: UPC portion of composite is transmitted using UPC rules.
	0	Standard data packet.
	1	Data packet containing the data following an encoded symbol separator character.
	2	Data packet containing the data following an escape mechanism character. The data packet does not support the ECI protocol.
	3	Data packet containing the data following an escape mechanism character. The data packet supports the ECI protocol.
		GS1-128 emulation Note: UPC portion of composite is transmitted using UPC rules.
	1	Data packet is a GS1-128 symbol (i.e., data is preceded with JC1).

Table B-2 AIM Code Modifier Characters (Continued)

Code Type	Option Value	Option
PDF417, Micro PDF417	0	Reader set to conform to protocol defined in 1994 PDF417 symbology specifications. Note: When this option is transmitted, the receiver cannot reliably determine whether ECIs have been invoked or whether data byte 92 _{DEC} has been doubled in transmission.
	1	Reader set to follow the ECI protocol (Extended Channel Interpretation). All data characters 92 _{DEC} are doubled.
	2	Reader set for Basic Channel operation (no escape character transmission protocol). Data characters 92 _{DEC} are not doubled. Note: When imagers are set to this mode, unbuffered Macro symbols and symbols requiring the imager to convey ECI escape sequences cannot be transmitted.
	3	The bar code contains a GS1-128 symbol, and the first codeword is 903-907, 912, 914, 915.
	4	The bar code contains a GS1-128 symbol, and the first codeword is in the range 908-909.
	5	The bar code contains a GS1-128 symbol, and the first codeword is in the range 910-911.
	Example: A PDF417 bar code ABCD, with no transmission protocol enabled, is transmitted as]L2ABCD.	
Data Matrix	0	ECC 000-140, not supported.
	1	ECC 200.
	2	ECC 200, FNC1 in first or fifth position.
	3	ECC 200, FNC1 in second or sixth position.
	4	ECC 200, ECI protocol implemented.
	5	ECC 200, FNC1 in first or fifth position, ECI protocol implemented.
MaxiCode	0	Symbol in Mode 4 or 5.
	1	Symbol in Mode 2 or 3.
	2	Symbol in Mode 4 or 5, ECI protocol implemented.
	3	Symbol in Mode 2 or 3, ECI protocol implemented in secondary message.

Table B-2 AIM Code Modifier Characters (Continued)

Code Type	Option Value	Option
QR Code	0	Model 1 symbol.
	1	Model 2 / MicroQR symbol, ECI protocol not implemented.
	2	Model 2 symbol, ECI protocol implemented.
	3	Model 2 symbol, ECI protocol not implemented, FNC1 implied in first position.
	4	Model 2 symbol, ECI protocol implemented, FNC1 implied in first position.
	5	Model 2 symbol, ECI protocol not implemented, FNC1 implied in second position.
	6	Model 2 symbol, ECI protocol implemented, FNC1 implied in second position.
Aztec	0	Aztec symbol.
	C	Aztec Rune symbol.

APPENDIX C SAMPLE BAR CODES

Code 39



UPC/EAN

UPC-A, 100 %



EAN-13, 100 %



Code 128



Interleaved 2 of 5



GS1 DataBar Omnidirectional



NOTE GS1 DataBar Omnidirectional must be enabled to read the bar code below (see [GS1 DataBar on page 12-75](#)).



7612341562341

PDF417

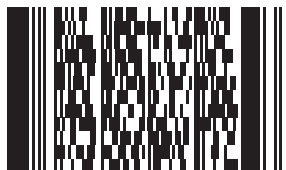

Data Matrix



Maxicode

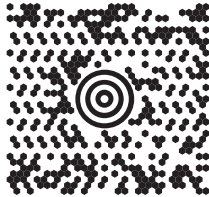

APPENDIX D NUMERIC BAR CODES

Numeric Bar Codes

For parameters requiring specific numeric values, scan the appropriately numbered bar code(s).

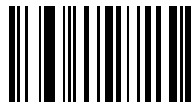

0



1



2



3

Numeric Bar Codes (continued)

For parameters requiring specific numeric values, scan the appropriately numbered bar code(s).



4



5



6



7



8



9

Cancel

To correct an error or change a selection, scan the bar code below.



Cancel

APPENDIX E ASCII CHARACTER SET

Table E-1 *ASCII Value Table*

ASCII Value	Full ASCII Code 39 Encode Char	Keystroke
1000	%U	CTRL 2
1001	\$A	CTRL A
1002	\$B	CTRL B
1003	\$C	CTRL C
1004	\$D	CTRL D
1005	\$E	CTRL E
1006	\$F	CTRL F
1007	\$G	CTRL G
1008	\$H	CTRL H/ BACKSPACE ¹
1009	\$I	CTRL I/ HORIZONTAL TAB ¹
1010	\$J	CTRL J
1011	\$K	CTRL K
1012	\$L	CTRL L
1013	\$M	CTRL M/ ENTER ¹
1014	\$N	CTRL N
1015	\$O	CTRL O

The keystroke in bold is sent only if the Function Key Mapping is enabled. Otherwise, the unbold keystroke is sent.

Table E-1 ASCII Value Table (Continued)

ASCII Value	Full ASCII Code 39 Encode Char	Keystroke
1016	\$P	CTRL P
1017	\$Q	CTRL Q
1018	\$R	CTRL R
1019	\$S	CTRL S
1020	\$T	CTRL T
1021	\$U	CTRL U
1022	\$V	CTRL V
1023	\$W	CTRL W
1024	\$X	CTRL X
1025	\$Y	CTRL Y
1026	\$Z	CTRL Z
1027	%A	CTRL [
1028	%B	CTRL \
1029	%C	CTRL]
1030	%D	CTRL 6
1031	%E	CTRL -
1032	Space	Space
1033	/A	!
1034	/B	"
1035	/C	#
1036	/D	\$
1037	/E	%
1038	/F	&
1039	/G	'
1040	/H	(
1041	/I)
1042	/J	*
1043	/K	+
1044	/L	,

The keystroke in bold is sent only if the Function Key Mapping is enabled. Otherwise, the unbold keystroke is sent.

Table E-1 ASCII Value Table (Continued)

ASCII Value	Full ASCII Code 39 Encode Char	Keystroke
1045	-	-
1046	.	.
1047	/o	/
1048	0	0
1049	1	1
1050	2	2
1051	3	3
1052	4	4
1053	5	5
1054	6	6
1055	7	7
1056	8	8
1057	9	9
1058	/Z	:
1059	%F	;
1060	%G	<
1061	%H	=
1062	%I	>
1063	%J	?
1064	%V	@
1065	A	A
1066	B	B
1067	C	C
1068	D	D
1069	E	E
1070	F	F
1071	G	G
1072	H	H
1073	I	I

The keystroke in bold is sent only if the Function Key Mapping is enabled. Otherwise, the unbold keystroke is sent.

Table E-1 ASCII Value Table (Continued)

ASCII Value	Full ASCII Code 39 Encode Char	Keystroke
1074	J	J
1075	K	K
1076	L	L
1077	M	M
1078	N	N
1079	O	O
1080	P	P
1081	Q	Q
1082	R	R
1083	S	S
1084	T	T
1085	U	U
1086	V	V
1087	W	W
1088	X	X
1089	Y	Y
1090	Z	Z
1091	%K	[
1092	%L	\
1093	%M]
1094	%N	^
1095	%O	_
1096	%W	'
1097	+A	a
1098	+B	b
1099	+C	c
1100	+D	d
1101	+E	e
1102	+F	f

The keystroke in bold is sent only if the Function Key Mapping is enabled. Otherwise, the unbold keystroke is sent.

Table E-1 ASCII Value Table (Continued)

ASCII Value	Full ASCII Code 39 Encode Char	Keystroke
1103	+G	g
1104	+H	h
1105	+I	i
1106	+J	j
1107	+K	k
1108	+L	l
1109	+M	m
1110	+N	n
1111	+O	o
1112	+P	p
1113	+Q	q
1114	+R	r
1115	+S	s
1116	+T	t
1117	+U	u
1118	+V	v
1119	+W	w
1120	+X	x
1121	+Y	y
1122	+Z	z
1123	%P	{
1124	%Q	
1125	%R	}
1126	%S	~

The keystroke in bold is sent only if the Function Key Mapping is enabled. Otherwise, the unbold keystroke is sent.

Table E-2 *ALT Key Standard Default Tables*

ALT Keys	Keystroke
2064	ALT 2
2065	ALT A
2066	ALT B
2067	ALT C
2068	ALT D
2069	ALT E
2070	ALT F
2071	ALT G
2072	ALT H
2073	ALT I
2074	ALT J
2075	ALT K
2076	ALT L
2077	ALT M
2078	ALT N
2079	ALT O
2080	ALT P
2081	ALT Q
2082	ALT R
2083	ALT S
2084	ALT T
2085	ALT U
2086	ALT V
2087	ALT W
2088	ALT X
2089	ALT Y
2090	ALT Z

Table E-3 *USB GUI Key Character Set*

GUI Key	Keystroke
3000	Right Control Key
3048	GUI 0
3049	GUI 1
3050	GUI 2
3051	GUI 3
3052	GUI 4
3053	GUI 5
3054	GUI 6
3055	GUI 7
3056	GUI 8
3057	GUI 9
3065	GUI A
3066	GUI B
3067	GUI C
3068	GUI D
3069	GUI E
3070	GUI F
3071	GUI G
3072	GUI H
3073	GUI I
3074	GUI J
3075	GUI K
3076	GUI L
3077	GUI M
3078	GUI N
3079	GUI O
3080	GUI P
3081	GUI Q

Note: GUI Shift Keys - The Apple™ iMac keyboard has an apple key on either side of the space bar. Windows-based systems have a GUI key to the left of the left ALT key, and to the right of the right ALT key.

Table E-3 *USB GUI Key Character Set (Continued)*

GUI Key	Keystroke
3082	GUI R
3083	GUI S
3084	GUI T
3085	GUI U
3086	GUI V
3087	GUI W
3088	GUI X
3089	GUI Y
3090	GUI Z

Note: GUI Shift Keys - The Apple™ iMac keyboard has an apple key on either side of the space bar. Windows-based systems have a GUI key to the left of the left ALT key, and to the right of the right ALT key.

Table E-4 *PF Key Standard Default Table*

PF Keys	Keystroke
4001	PF 1
4002	PF 2
4003	PF 3
4004	PF 4
4005	PF 5
4006	PF 6
4007	PF 7
4008	PF 8
4009	PF 9
4010	PF 10
4011	PF 11
4012	PF 12
4013	PF 13
4014	PF 14
4015	PF 15
4016	PF 16

Table E-5 *F key Standard Default Table*

F Keys	Keystroke
5001	F 1
5002	F 2
5003	F 3
5004	F 4
5005	F 5
5006	F 6
5007	F 7
5008	F 8
5009	F 9
5010	F 10
5011	F 11
5012	F 12
5013	F 13
5014	F 14
5015	F 15
5016	F 16
5017	F 17
5018	F 18
5019	F 19
5020	F 20
5021	F 21
5022	F 22
5023	F 23
5024	F 24

Table E-6 *Numeric Key Standard Default Table*

Numeric Keypad	Keystroke
6042	*
6043	+
6044	Undefined

Table E-6 *Numeric Key Standard Default Table (Continued)*

Numeric Keypad	Keystroke
6045	-
6046	.
6047	/
6048	0
6049	1
6050	2
6051	3
6052	4
6053	5
6054	6
6055	7
6056	8
6057	9
6058	Enter
6059	Num Lock

Table E-7 *Extended Keypad Standard Default Table*

Extended Keypad	Keystroke
7001	Break
7002	Delete
7003	Pg Up
7004	End
7005	Pg Dn
7006	Pause
7007	Scroll Lock
7008	Backspace
7009	Tab
7010	Print Screen
7011	Insert
7012	Home
7013	Enter
7014	Escape
7015	Up Arrow
7016	Dn Arrow
7017	Left Arrow
7018	Right Arrow

INDEX

Numerics

123Scan	14-1
2D bar codes	
aztec	12-90
aztec inverse	12-91
code 128 emulation	12-84
data matrix	12-85
data matrix inverse	12-86
maxicode	12-88
microPDF417	12-83
MicroQR	12-90
PDF417	12-83
QR code	12-88
QR inverse	12-89

A

accessories	2-16
adding window	2-11
ADF	15-1
advanced data formatting	15-1
aiming	3-1
control	3-2
LED spec	4-3
aiming options	
decode aiming pattern	7-6
snapshot aiming pattern	7-14
snapshot mode timeout	7-14
video view finder	7-32
aiming pattern	7-14
enabling	7-6
orientation	3-3
aiming tips	3-3
ambient light immunity	4-3
anti-reflection coaters	2-13
ASCII values	E-1

serial	9-19
USB	10-18
assembling stand	2-3
autoexposure	7-5, 7-12

B

bar codes	
AAMVA field parsing	13-6
Australia post format	12-72
autoexposure	7-5, 7-12
aztec	12-90
aztec inverse	12-91
beep after good decode	6-8
beeper tone	6-9
beeper volume	6-10
bits per pixel	7-27, 7-30
bookland EAN	12-11
bookland ISBN	12-24
codabar start and stop characters	12-58
code 128 emulation	12-84
code 128 security level	12-33
code 39	
transmit buffer	12-40
code39 security level	12-42
composite CC-A/B	12-79
composite CC-C	12-79
composite TLC-39	12-80
continuous bar code read	6-20
continuous snapshot	7-15
coupon report	12-26
crop to address	7-17
data matrix	12-85
data matrix inverse	12-86
data options	6-37
prefix/suffix values	6-38
transmit code ID character	6-37

- decode aiming pattern 7-6
- decode session timeout 6-19
- discrete 2 of 5
 - lengths 12-54
- driver's license parsing 13-1
 - set up 13-3
- EAN-13/JAN-13 12-11
- EAN-8/JAN-8 12-10
- decode mirror images 12-87
- event reporting
 - boot up event 8-19
 - decode event 8-18
 - parameter event 8-19
- exposure time 7-13
- field updates 13-22
- fixed gain 7-13
- flush macro buffer/abort macro PDF entry ... 12-99
- GS1 databar limited security level 12-77
- I 2 of 5 security level 12-52
- illumination 7-6, 7-12
- image brightness (target white) 7-19
- image cropping 7-16
- image enhancement 7-23
- image file format 7-20, 7-29
- image file meta data 7-22
- image resolution 7-18
- imager
 - default table 7-2
- interleaved 2 of 5 12-48
 - convert to EAN-13 12-33, 12-51, 12-52
 - lengths 12-49, 12-50
- inverse 1D 12-67
- JPEG image options 7-20
- JPEG quality and size 7-21
- low light enhancement 7-8
- maxicode 12-88
- microPDF417 12-83
- MicroQR 12-90
- mirrored image 6-21
- miscellaneous
 - scan data options 6-39
 - transmit no read msg 6-41
- mobile phone/display mode 6-22
- multicode expression 6-25
- multicode expression examples 6-27
- multicode expression via SSI 6-31
- multicode mode 6-24
- numeric bar codes D-3
- OCR
 - bright illumination 11-15
 - check digit 11-25
 - check digit multiplier 11-26
 - check digit validation 11-27
 - default table 11-2
 - inverse OCR 11-31
 - lines 11-12
 - maximum characters 11-13
 - MICR E13B 11-9
 - minimum character 11-13
 - OCR-A 11-3
 - OCR-A variant 11-3
 - OCR-B 11-5
 - OCR-B variant 11-6
 - orientation 11-10
 - parameters 11-3
 - quiet zone 11-14
 - security level 11-13
 - subset 11-14
 - template 11-16
 - US currency serial number 11-10
- operational mode 7-4
- parameter scanning 6-6
- parser version ID 13-15
- parsing ADF example 13-20
- parsing rule example 13-16
- PDF prioritization 6-23
- PDF prioritization timeout 6-23
- PDF417 12-83
- picklist mode 6-19
- postal 12-68
- power mode 6-17
- prefix/suffix values 6-38
- presentation mode field of view 7-9
- presentation performance mode 6-12
- presentation snapshot 7-15
- QR code 12-88
- QR inverse 12-89
- RS-232
 - beep on bel 10-17
- serial
 - baud rate 9-7
 - beep on bel 9-16
 - check receive errors 9-10
 - data bits 9-9
 - default table 9-2
 - hardware handshaking 9-11, 9-12
 - host serial response time-out 9-15
 - host types 9-5
 - intercharacter delay 9-17
 - parity 9-9
 - RTS line state 9-16
 - software handshaking 9-13
 - stop bit select 9-16
- set defaults 6-5, 13-23
- signature capture 7-28
- signature capture height 7-31
- signature capture JPEG quality 7-31
- signature capture width 7-30

- snapshot aiming pattern 7-14
- snapshot mode 7-5
- snapshot mode timeout 7-14
- SSI
 - baud rate 8-9, 8-10
 - check parity 8-12
 - data packet format 8-13
 - host character timeout 8-15
 - host RTS line state 8-13
 - host serial response time-out 8-14
 - interpacket delay 8-17
 - multipacket option 8-16
 - parity 8-11
 - software handshaking 8-12
- supplemental AIM ID format 12-16
- supplementals 12-12
- suppress power-up beeps 6-10
- symbologies
 - Australian postal 12-71
 - buffering 12-39
 - check ISBT table 12-32
 - Chinese 2 of 5 12-63
 - codabar 12-55
 - codabar CLSI editing 12-57
 - codabar lengths 12-55, 12-56
 - codabar NOTIS editing 12-57
 - code 11 12-45
 - code 11 lengths 12-45, 12-46
 - code 128 12-28, 12-30
 - code 128 lengths 12-28
 - code 39 12-34
 - code 39 check digit verification 12-37
 - code 39 full ASCII 12-38
 - code 39 lengths 12-29, 12-36
 - code 39 transmit check digit 12-38
 - code 93 12-43
 - code 93 lengths 12-43, 12-44
 - convert GS1 DataBar to UPC/EAN 12-78
 - convert UPC-E to UPC-A 12-22
 - convert UPC-E1 to UPC-A 12-22
 - default table 12-2
 - discrete 2 of 5 12-53
 - discrete 2 of 5 lengths 12-53
 - EAN zero extend 12-23
 - GS1 DataBar 12-75
 - GS1 DataBar expanded 12-78
 - GS1 DataBar limited 12-76
 - GS1 DataBar Omnidirectional 12-75
 - GS1-128 12-30
 - I 2 of 5 check digit verification 12-50
 - I 2 of 5 convert to EAN-13 12-51
 - I 2 of 5 transmit check digit 12-51
 - ISBT concatenation 12-31
 - ISBT concatenation redundancy 12-32
 - ISSN EAN 12-27
 - Japan postal 12-70
 - matrix 2 of 5 12-63, 12-66
 - matrix 2 of 5 check digit 12-65
 - matrix 2 of 5 lengths 12-64
 - matrix 2 of 5 transmit check digit 12-65
 - MSI 12-59
 - MSI check digit algorithm 12-62
 - MSI check digits 12-61
 - MSI lengths 12-59, 12-60
 - MSI transmit check digit 12-62
 - Netherlands KIX code 12-73
 - transmit UK postal check digit 12-70
 - transmit US postal check digit 12-69
 - UCC coupon extended code 12-25
 - UK postal 12-69
 - UPC-A preamble 12-19
 - UPC-A/E/E1 check digit 12-17, 12-18
 - UPC-E preamble 12-20
 - US planet 12-68
 - US postnet 12-68
 - time delay to low power mode 6-17
 - time delay to presentation idle mode 6-13
 - time delay to presentation sleep mode 6-15, 6-16
 - timeout between decodes 6-20
 - trigger modes 6-11
 - unique bar code reporting 6-21
 - UPC composite mode 12-81
 - UPC/EAN
 - coupon code 12-25
 - supp redundancy 12-15
 - UPC/EAN/JAN
 - supplemental redundancy 12-15
 - UPC-A 12-9
 - UPC-E 12-9
 - UPC-E1 12-10
 - UPU FICS postal 12-74
 - USB
 - caps lock override 10-8
 - convert case 10-13
 - country keyboard types 10-6
 - default table 10-2
 - device type 10-3
 - emulate keypad 10-9
 - emulate keypad with leading zero 10-10
 - fast HID keyboard 10-17
 - function key mapping 10-11
 - IBM specification level 10-17
 - ignore beep directive 10-14
 - ignore type directive 10-14
 - keyboard FN1 substitution 10-11
 - keystroke delay 10-8
 - polling interval 10-15, 10-16
 - quick emulation 10-10

simulated caps lock	10-12
SNAPI handshaking	10-5
static CDC	10-13
unknown characters	10-9
user parameter pass through	6-7
USPS 4CB/One Code/Intelligent Mail	12-74
validate concatenated parameter bar codes	6-22
video frame size	7-33
video mode	7-5
video mode format selector	7-32
video view finder	7-32
wand emulation	
default table	8-8
beeper	3-4
suppress power-up beeps	6-10
block diagram	1-3
component descriptions	1-3

C

chapter descriptions	xv
character sets	E-1
serial	9-19
USB	10-18
Chinese 2 of 5	12-63
codabar bar codes	
CLSI editing	12-57
codabar	12-55
lengths	12-55, 12-56
NOTIS editing	12-57
start and stop characters	12-58
code 11 bar codes	
code 11	12-45
lengths	12-45, 12-46
code 128 bar codes	
check ISBT table	12-32
code 128	12-28, 12-30
GS1-128	12-30
ISBT concatenation	12-31
ISBT concatenation redundancy	12-32
lengths	12-28
security level	12-33
code 128 emulation bar codes	12-84
code 39 bar codes	
buffering	12-39
check digit verification	12-37
code 39	12-34
full ASCII	12-38
lengths	12-29, 12-36
security level	12-42
transmit check digit	12-38
code 93 bar codes	
code 93	12-43
lengths	12-43, 12-44

code identifiers	
AIM code IDs	B-1
composite bar codes	
composite CC-A/B	12-79
composite CC-C	12-79
composite TLC-39	12-80
UPC composite mode	12-81
configurations	xv
conventions	
notational	xvi
cropping	7-16, 7-17

D

data capture	3-3
data matrix bar codes	12-85
decode distances	
DP focus	4-11
HD focus	4-11
SR focus	4-8
decode mode	7-4
decode zones	4-6
DP focus	4-9
HD focus	4-9
SR/DL focus	4-6
default parameters	
OCR	11-2
serial	9-2
standard default table	A-1
sybologies	12-2
USB	10-2
user preferences	6-3, 7-2
wand emulation	8-8
dimensions	4-2, 4-4
direct part marking	1-2, 3-3
discrete 2 of 5 bar codes	
discrete 2 of 5	12-53
lengths	12-53
DP focus decode distances	4-11
DPM	1-2, 3-3
driver's license parsing	13-1
AAMVA field bar codes	13-6
bar codes	13-1
embedded	13-2
embedded ADF example	13-20
field bar codes	13-3
field updates	13-22
rule example	13-16
send control characters	13-23
send keyboard characters	13-28
set defaults	13-23
version ID	13-15
drop specification	4-3

E

electrical interface	4-1
engine	1-3
theory of operation	1-2
escape characters	12-98
exit window	
diagram	2-14
properties	2-15
exposure options	
autoexposure	7-5, 7-12
exposure time	7-13
fixed gain	7-13
illumination	7-6, 7-12
low light enhancement	7-8
presentation mode field of view	7-9
exposure time	7-13

F

field of view specification	4-3
fixed gain	7-13
focal positions	
distance from imager	4-3

G

gain	
fixed	7-13
GS1 DataBar	12-75
convert GS1 DataBar to UPC/EAN	12-78
GS1 DataBar expanded	12-78
GS1 DataBar limited	12-76
GS1 DataBar Omnidirectional	12-75

H

HD focus decode distances	4-11
host types	
serial	9-5
humidity specification	4-3

I

illumination	7-6, 7-12
element	4-3
illumination system	3-2
image brightness (target white)	7-19
image cropping	7-16, 7-17
image enhancement	7-23
image options	
bits per pixel	7-27, 7-30
cropping	7-16, 7-17
file formats	7-20, 7-29

image brightness (target white)	7-19
image enhancement	7-23
image resolution	7-18
JPEG	7-20
JPEG size/quality	7-21
video frame size	7-33
image resolution	7-18
imager	
defaults	7-2
imager overview	1-1
imaging engine	1-3
information, service	xviii
installation	
connecting	2-8
location	2-10
mechanical drawing	4-2
mounting	2-2
mounting imager on stand	2-3, 2-5, 2-7
mounting stand	2-4
stand	2-3
interface pin-outs	4-1
interleaved 2 of 5 bar codes	
check digit verification	12-50
convert to EAN-13	12-51
security level	12-52
transmit check digit	12-51

J

JPEG image options	7-20
size/quality	7-21

L

laser	3-1
LED	3-2
decode	3-4
low light enhancement	7-8

M

macro PDF	12-96
buffer all symbols	12-97
escape characters	12-98
flush buffer/abort PDF entry	12-99
transmit any symbol in set	12-97
transmit user-selected fields	12-98
transmit/decode mode symbols	12-97
maintenance	5-1
matrix 2 of 5	12-63, 12-66
matrix 2 of 5 check digit	12-65
matrix 2 of 5 lengths	12-64
matrix 2 of 5 transmit check digit	12-65
maxicode bar codes	12-88

- mechanical drawing 4-2
 - microPDF417 bar codes 12-83
 - microprocessor 1-4
 - modes of operation 3-5
 - mounting 2-2
 - dimensions 2-2
 - imager on stand 2-3, 2-5, 2-7
 - stand 2-4
 - MSI bar codes
 - check digit algorithm 12-62
 - check digits 12-61
 - lengths 12-59, 12-60
 - MSI 12-59
 - transmit check digit 12-62
 - multicode mode
 - expression examples 6-27
 - multicode expression 6-25
 - setting 6-24
 - setting expression via SSI 6-31
 - troubleshooting 6-35
- N**
- notational conventions xvi
- O**
- OCR
 - default parameters 11-2
 - parameters 11-3
 - operating modes 3-5
 - operational mode 7-4
 - decode mode 7-4
 - snapshot mode 7-4
 - video mode 7-5
 - optical
 - path and exit window diagram 2-14
 - resolution 4-3
 - overview
 - imager 1-1
- P**
- PDF417 bar codes 12-83
 - PDF prioritization 6-23
 - pitch 4-3
 - postal codes 12-68
 - Australia post format 12-72
 - Australian postal 12-71
 - Japan postal 12-70
 - Netherlands KIX code 12-73
 - transmit UK postal check digit 12-70
 - transmit US postal check digit 12-69
 - UK postal 12-69
 - UPU FICS postal 12-74
 - US planet 12-68
 - US postnet 12-68
 - USPS 4CB/One Code/Intelligent Mail 12-74
 - power requirements 4-3
 - presentation mode field of view 7-9
 - processing/control board
 - theory of operation 1-2
 - programming parameters
 - escape characters 12-98
 - macro PDF transmit/decode mode symbols 12-97
 - transmit macro PDF user-selected fields 12-98
- Q**
- QR code bar codes 12-88
- R**
- roll 4-3
- S**
- scanning
 - errors 6-2, 7-2, 12-2
 - sequence example 6-2, 7-2, 12-2
 - SE4500 1-3
 - serial
 - default parameters 9-2
 - parameters 9-3, 9-5
 - service information xviii
 - signature capture 7-28
 - bits per pixel 7-30
 - file format selector 7-29
 - height 7-31
 - JPEG quality 7-31
 - width 7-30
 - simple serial interface
 - commands 8-2
 - communications 8-1, 8-5
 - handshaking 8-3, 8-5
 - RTS CTS 8-5
 - transactions 8-3
 - skew 4-3
 - skew, pitch and roll 4-5
 - SNAPI
 - SDK 2-17
 - snapshot mode 7-4
 - snapshot mode timeout 7-14
 - software 2-17
 - software developer's kit
 - SNAPI 2-17
 - SSI 2-17
 - specifications 4-3

SR focus decode distances	4-8
SSI	
commandss	8-2
communications	8-1, 8-5
handshaking	8-3, 8-5
RTS CTS	8-5
SDK	2-17
transactions	8-3
stand	
mounting	2-4
mounting imager	2-3, 2-5, 2-7
standard default parameters	A-1
symbology default parameters	12-2

T

technical specifications	4-3
temperature specification	4-3
theory of operation	
engine	1-2
processing/control board	1-2
troubleshooting	5-2
multicode mode	6-35

U

UPC/EAN bar codes	
bookland EAN	12-11
bookland ISBN	12-24
check digit	12-17, 12-18
convert UPC-E to UPC-A	12-22
convert UPC-E1 to UPC-A	12-22
coupon report	12-26
EAN zero extend	12-23
EAN-13/JAN-13	12-11
EAN-8/JAN-8	12-10
ISSN EAN	12-27
supplemental AIM ID format	12-16
supplementals	12-12
UCC coupon extended code	12-25
UPC-A	12-9
UPC-A preamble	12-19
UPC-E	12-9
UPC-E preamble	12-20
UPC-E1	12-10
USB	
default parameters	10-2
parameters	10-3
user preferences parameters	6-3, 7-2

V

video formats	7-32
video mode	7-5
video view finder	7-32

W

wand emulation default parameters	8-8
weight	4-4
window	
adding	2-11
window coatings	2-12
anti-reflection	2-12
polysiloxane	2-12
window manufacturers	2-13
window material	2-11
acrylic	2-11
CR-39	2-11
glass	2-11
window properties	2-12



Zebra Technologies Corporation
Lincolnshire, IL U.S.A.
<http://www.zebra.com>

©2017 ZIH Corp and/or its affiliates. All rights reserved. ZEBRA and the stylized Zebra head are trademarks of ZIH Corp, registered in many jurisdictions worldwide. All other trademarks are the property of their respective owners.

